

SDS TECHNICAL INFORMATION

SDS 900 SERIES SYMBOL TECHNICAL MANUAL

SDS 900688A

March 1965

SDS 900 SERIES SYMBOL TECHNICAL MANUAL

SDS 900688A

March 1965

SDS

SCIENTIFIC DATA SYSTEMS/1649 Seventeenth Street/Santa Monica, California

CONTENTS

	Page
Introduction	v
SDS 900 Series SYMBOL System Description (Catalog No. 012008)	1-1
SYMBOL Loader (Catalog No. 012012)	2-1
Paper Tape Reader or Typewriter Symbolic Input Subroutine (Catalog No. 020024)	3-1
Card Reader Symbol Input Subroutine (Catalog No. 030009)	3-6
Magnetic Tape Symbolic Input Subroutine (Catalog No. 040007)	3-8
Paper Tape Punch Binary Output Subroutine (Catalog No. 020025)	3-12
Card Punch Binary Output Subroutine (Catalog No. 030008)	3-14
Typewriter Listing Subroutine (Catalog No. 020023)	3-17
Line Printer Listing Subroutine (Catalog No. 062002)	3-22
900 Series SYMBOL Part I (Catalog No. 012005)	4-1
900 Series SYMBOL Part II (Catalog No. 012009)	5-1
900 Series SYMBOL Part III (Catalog No. 012010)	6-1
900 Series SYMBOL 910 Mnemonic Table (Catalog No. 012006)	7-1
900 Series SYMBOL 920 Mnemonic Table (Catalog No. 012011)	7-21
900 Series SYMBOL 9300 Mnemonic Table (Catalog No. 012007)	7-50
Index of Subroutines	

INTRODUCTION

This manual contains operating instructions, technical descriptions, flow charts, and listings for the 900 Series Computer SYMBOL Assembler. This material supplements the SYMBOL and META-SYMBOL Reference Manual and provides information for possible modification and maintenance of the assembler.

To use this assembler with maximum efficiency, the programmer should be conversant with the machine instructions described in the reference manual for the applicable SDS 900 Series Computer.

Input may be from paper tape, cards, magnetic tape, or typewriter keyboard.

**SDS PROGRAM LIBRARY
PROGRAM DESCRIPTION**

Page 1 of 9

Catalog No. 012008

IDENTIFICATION: SDS 900 Series SYMBOL System Description

AUTHOR: SDS

ACCEPTED: January 21, 1965

COMPUTER
CONFIGURATION: Any SDS 900 series computer with at least 4,096 words of magnetic core memory, a typewriter, and an output device (punched paper tape or cards and/or buffered line printer).

PURPOSE: To assemble source programs written in the SYMBOL assembly language.

USE: 1.0 General

SYMBOL is a two-pass assembly program for the SDS 900 series and 9300 computers. It is designed to operate on a minimal 4K computer with at least one symbolic input device and at least one output device.

The assembler proper consists of three parts and requires a total of

Part I: 01463

Part II: 02102

Part III: 00725

04512 words

To this total must be added the load origin (00366 for the 910/925, 00233 for the 920 and 00161 for the 9300), the length of the I/O subroutines to be loaded, and the length of the mnemonic table. All remaining memory is used for working storage, irrespective of the computer size. While available space is thus variable, there is in general space for approximately 300 symbols (literals, external references, OPDs and POPDs) on a computer with 4K memory. An additional nK memory will provide space for nK/3 additional items.

USE: (Cont)

During the first pass, source lines are read and a location counter is maintained which is used for defining labels. All labels are defined in pass 1. Except for label fields, only directive lines are processed during pass 1. Other lines may cause the location counter to be incremented by the operand field of such lines are not processed. Consequently, no literals or external references are processed during pass 1.

At the conclusion of pass 1, all labels which have been designated as external labels are output. No further entries can be made in the mnemonic table or in the symbol table. During pass 2, all lines are completely processed and both object code and a listing are generated. Literals are inserted in the literal table and references are inserted in the reference table. At the conclusion of pass 2, the literals are output and finally the references are output.

At this point, another assembly may be started without reloading the assembler. Before doing the assembly, SYMBOL will clear the mnemonic command table of any programmer defined entries left over from the previous assembly.

2.0 SYMBOL Paper Tape (Card Deck) System

A SYMBOL system consists of the following segments:

1. SYMBOL Loader (Cat. No. 012012). The SYMBOL loader consists of an absolute bootstrap, a pre-loader and a loader.
2. Input/Output Subroutines
 - a. Paper Tape/Typewriter Input Subroutine (Cat. No. 020024)
 - b. Card Reader Input Subroutine (Cat. No. 030009)

USE: (Cont)

- c. Magnetic Tape Input Subroutine
(Cat. No. 040007)
 - d. Paper Tape Punch Binary Output Subroutine ✓
(Cat. No. 020025)
 - e. Card Punch Binary Output Subroutine
(Cat. No. 030008)
 - f. Typewriter Listing Output Subroutine ✓
(Cat. No. 020023)
 - g. Line Printer Listing Output Subroutine ✓
(Cat. No. 062002)
- 3. SYMBOL Part I (Cat. No. 012005)
 - 4. SYMBOL Part II (Cat. No. 012009)
 - 5. SYMBOL Part III (Cat. No. 012010)
 - 6. SYMBOL Mnemonic Table
 - a. 900 Series SYMBOL 910 Mnemonic Table ✓
(Cat. No. 012006)
 - b. 900 Series SYMBOL 920 Mnemonic Table
(Cat. No. 012011)
 - c. 900 Series SYMBOL 9300 Mnemonic Table
(Cat. No. 012007)

As stated in the SYMBOL Loader description, the order and number of the I/O subroutines is unimportant. Similarly, the internal ordering of the SYMBOL Parts I, II and III is unimportant. There must be only one of the above mentioned mnemonic tables included in a system.

The SYMBOL paper tape system may be updated, or put together originally by reproducing each segment onto one continuous paper tape, through the use of the SYMBOL Reproduce and Update routine (Cat. No. 012014).

USE: (Cont) 3.0 Memory Allocation

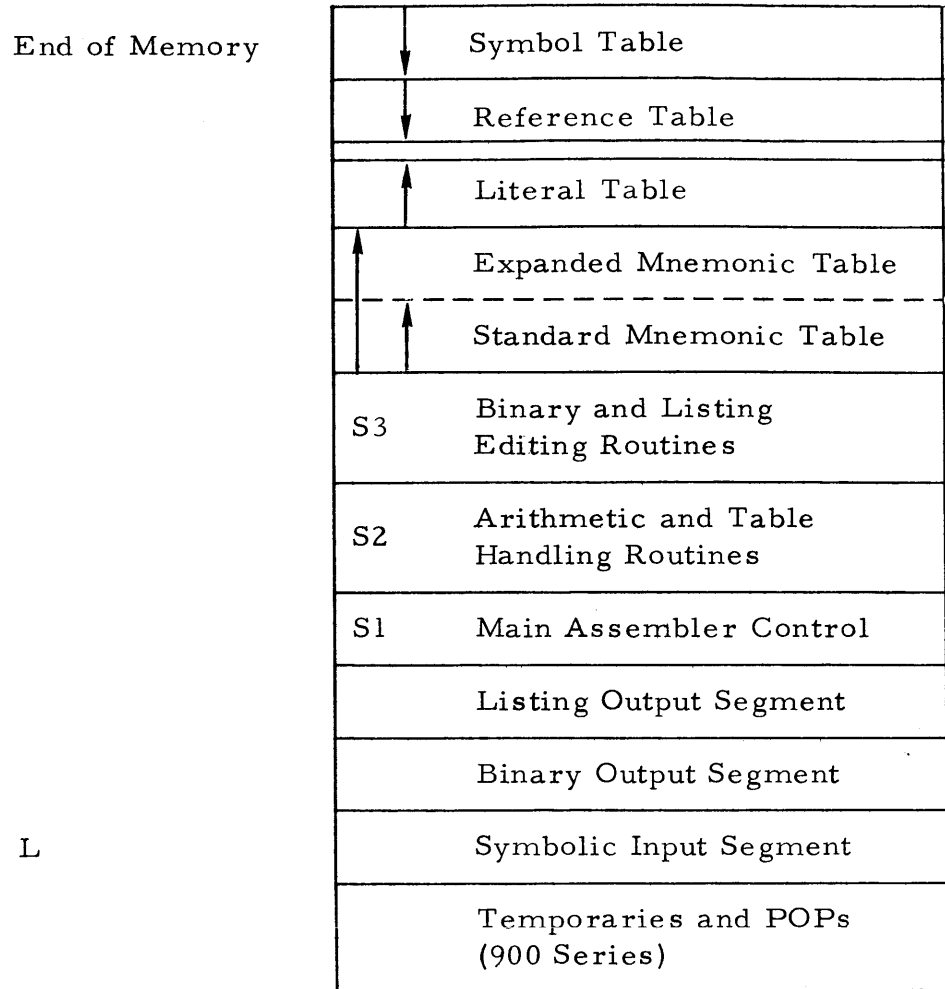

00000

910, 925: L = 00366
 920, 930: L = 00233
 9300 L = 00161

During pass 1, OPD and FORM definitions are added to the Standard Op Table to form the Mnemonic Table. A flag is set in such entries to enable them to be extracted before a new assembly is started.

USE: (Cont)

The SYMBOL table starts at the end of memory and new entries cause the table to be expanded downward (to lower numbered locations). Entries are made in this table only during pass 1.

During pass 2, literals are processed and cause entries to be inserted in the literal table. The literal table begins at the (high) end of the mnemonic table and new entries cause the table to be expanded upwards.

Also during pass 2, external references are processed and cause entries to be inserted in the reference table. The reference table begins at the (low) end of the symbol table and new entries cause the table to be expanded downwards.

4.0 Tables

Mnemonic Table Entries

<u>Bits</u>	<u>Word</u>	
0-23	1	First four characters of symbol
0-11	2	Fifth and sixth characters of symbol
12, 20	2	I/O command with unit and channel to be supplied (e.g., RPT)
13	2	Programmed operator
16	2	Not used
17	2	Duplicate Flag
18	2	Programmer defined entry (OPD, FORM, POPD or external POP)
19	2	Instruction, octal address
20	2	Instruction, I/O command with channel specified (e.g., RPTW)
21	2	Directive, special label definition
22	2	Directive, normal label definition
23	2	Form

USE: (Cont)

If bits 12, 21, 22 and 23 are off, the third word contains the data word without parameters.

The third word of directive entries (bit 21 or 22 on) contains the starting address of the lines of instructions which process the directive line encountered.

The third word of a form item (bit 23 on) contains a form pattern word; i. e., a word with a one in the leading bit position of each field, and zeros elsewhere.

The third word of a programmed operator entry (bit 13) has the following format:

Bits 0-1	Type (0 internal definition, 1 external reference, 2 external definition)
Bits 2-7	Programmed operator number (assigned at end of pass 1)
Bit 8	Relocation bit (if definition)
Bits 9-23	Address of programmed operator interpretive code

Symbol Table Entries

<u>Bits</u>	<u>Word</u>	
0-23	1	First four characters of symbol
0-11	2	Fifth and sixth characters of symbol
17	2	Duplicate flag
22	2	Relocatable flag
23	2	External flag
0-23	3	Value

USE: (Cont)

Reference Table Entries

<u>Bits</u>	<u>Word</u>	
0-23	1	First four characters of symbol
0-11	2	Fifth and sixth characters of symbol
0-23	3	Location of last data word to reference this symbol

Literal Table Entries

<u>Bits</u>	<u>Word</u>	
0-23	1	Literal value
22	2	Relocatable flag
0-8	3	Literal sequence
9-23	3	Location literal will occupy in the object program

5.0 Operation

1. Load SYMBOL Loader by a FILL procedure.
2. Type Loader control message to provide for selective loading of I/O routines (see SYMBOL loader writeup for syntax and other details).
3. Ready input.
4. Clear the halt.
5. After pass 1, the computer will perform the following action:

Paper Tape/Typewriter : Halt. In order to continue, reposition input and clear the halt.

Cards : The computer will remain in a CRT, BRU \$-1 loop until the card reader is again made ready.

USE: (Cont) Magnetic Tape : No operator intervention required.

6. After pass 2, the computer will halt prepared to under take an additional assembly.

6.0 Diagnostics

SYMBOL provides the user with an unusual degree of error detection, which is conveyed by the appearance of up to four single-character diagnostic flags in columns 1-4 of the output listing. These flags and their meanings are explained below.

<u>Flag</u>	<u>Error</u>	<u>Action</u>
D	Duplicate	Duplicate symbol definition or reference. References to duplicate symbols take the value of the first definition.
E	Expression	Illegal expression in operand field. Operand interpretation is terminated.
I	Instruction	Instruction mnemonic not defined. Treated as HLT for 9300 and as implicit POP reference for 900 series.
L	Label	Illegal symbol in label field.
P	Parentheses	Too many parentheses levels or unequal number of left and right parentheses. Operand interpretation is terminated.
R	Relocation	Operand expression involves illegal use of one or more relocatable items. The correct (but non-relocatable) value of the expression is determined and output.

USE: (Cont)	T	Truncation	Significant bits were lost due to left-hand truncation in inserting a value into a specified field. If the field size is n , the result is the value of the expression modul 2^n .
	*	External	An external address reference has been made which may or may not be in error.
	U	Undefined	A reference has been made to an undefined symbol in other than the address field. Zero is substituted for the undefined value.
	O	Overflow	The assembler's symbol table has overflowed, but assembly continues. Recovery is possible only by reducing the number of symbols through elimination or through program segmentation.

**SDS PROGRAM LIBRARY
PROGRAM DESCRIPTION**

Page 1 of 4

Catalog No. 012012

IDENTIFICATION: 900 Series SYMBOL Loader

AUTHOR: SDS

ACCEPTED: January 21, 1965

COMPUTER
CONFIGURATION: Any SDS 900 Series computer with at least 4,096 words of memory, a typewriter and either a paper tape or a card reader.

PURPOSE: To load the SYMBOL assembler.
To load selectively the input/output routines for SYMBOL as specified by the operator.
To determine memory size for SYMBOL.
To load the appropriate Programmed Operators (900 series only).

STORAGE: 00000 - 00161 : Read Buffer, READ, LOAD and END Routines
04000 - 04264 : Control Message Processor
(X-00210)-X : Main Loader Logic, where X = highest address in the computer

After the control message has been received and processed, and the I/O routines have been loaded, the control message processor is overlaid.

In addition to the above, a Programmed Operator Package is loaded for the 900 Series SYMBOL which extends from 00161 to 00233 for the 920, 930 (00161 to 00366 for the 910, 925).

USE: The SYMBOL Loader is preceded by an absolute bootstrap (Cat. No. 020020 for paper tape, Cat. No. 030006B for cards), and a pre-loader which computes memory size and relocates it into upper memory. It is loaded by the normal FILL procedure. Upon completion of loading, the Loader addresses the console keyboard to permit the operator to specify the I/O media appropriate to the current assembly.

USE: (Cont)

The operator should in addition set Breakpoint 1 if the Loader is to load SYMBOL from cards. After SYMBOL has been loaded, a halt will occur (in a location whose value depends upon the machine and upon the length of the I/O routines loaded. At this time the operator has only to ready the symbolic input and clear the halt. This is the only halt present in the assembler.

Following the first assembly, SYMBOL will reinitialize itself and halt in the same location, ready to process another program. It is not necessary to reload the assembler unless different I/O media are required.

The loading process may be reinitialized at any time prior to the reading of the first record by the execution of a branch to location 1.

Control Message Syntax

A control message consists of the character Δ followed by from one to three of the characters M, P, T, C, L, N and terminated by a carriage return. These characters have the following significance:

1st character	:	Symbolic Input Device
2nd character	:	Binary Output Device
3rd character	:	Listing Output Device
M	:	Magnetic Tape
P	:	Paper Tape
T	:	Typewriter
C	:	Cards
L	:	Line Printer
N	:	None

A control message may be cancelled at any time preceding the carriage return by typing a virgule (/).

Characters absent from the control message are considered equivalent to trailing N's.

USE: (Cont)

Examples

$\Delta C P T G_R$: SI = Cards, BO = Paper Tape,
 LO = Typewriter
 $\Delta P P G_R$: SI = Paper Tape, BO = Paper
 Tape, LO = None
 $\Delta M R / \Delta M C L G_R$: SI = Magnetic Tape, BO =
 Cards, LO = Line Printer

Halts

00120 : Input error: buffer error, checksum error or
 card feed error. To recover, reread the
 offending record.
 07643 : Loader's symbol table has overflowed. This halt
 cannot occur during loading the standard SDS
 910/925, 920/930 or 9300 assemblers, but can
 occur when loading the 910/925 assembler with
 the 920/930 op table on a minimal (4K) 910/925.
 It could also occur in the event that the user re-
 placed the standard I/O subroutines with ones
 that were more space consuming.

METHOD:

After addressing the keyboard, the Loader ignores all
 characters until a Δ has been read, and then accumulates
 up to three characters until a carriage return is received.
 The first character is associated with symbolic input, the
 second with binary output, and the third with listing output.
 Thus, if the characters C, P and T have been input, the
 associations CSI, PBO and TLO are made.

Next an input record is read and scanned for an external
 definition coinciding with CSI, PBO or TLO. If coincidence
 is detected, all records are read and accepted until an END
 record is encountered. If coincidence is not detected, the
 input record is scanned for the appearance of any legitimate
 I/O external definition (such as PSI, LLO, etc.). If one is
 found, the record is known to herald an I/O routine, the
 Loader reads but ignores all records up to and including the
 END record, and the above process is repeated. If however
 none is found, the I/O routines are exhausted and the Loader

METHOD: (Cont)

abandons search mode for load mode. All records are now read until an end record with transfer address is encountered.

By adhering to these conventions, the user may at will add additional I/O routines to correspond to non-standard peripheral devices. While the order and number of I/O routines is unimportant, they must all be grouped together between the loader and the assembler. Similarly, the three assembler parts may be in any order but the mnemonic table must be loaded last.

900 SERIES SYMBOL LOADER

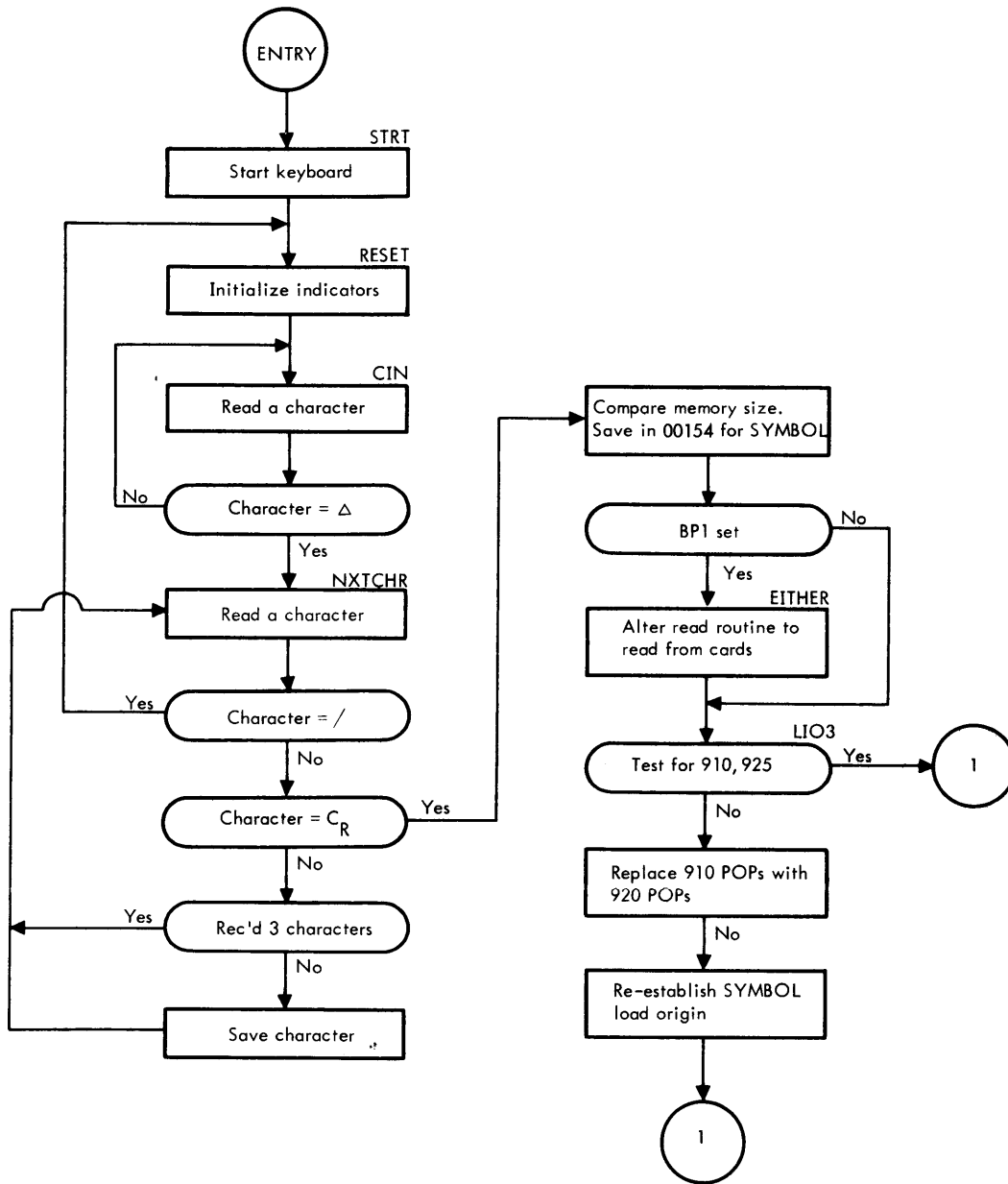

900 SERIES SYMBOL LOADER (cont.)

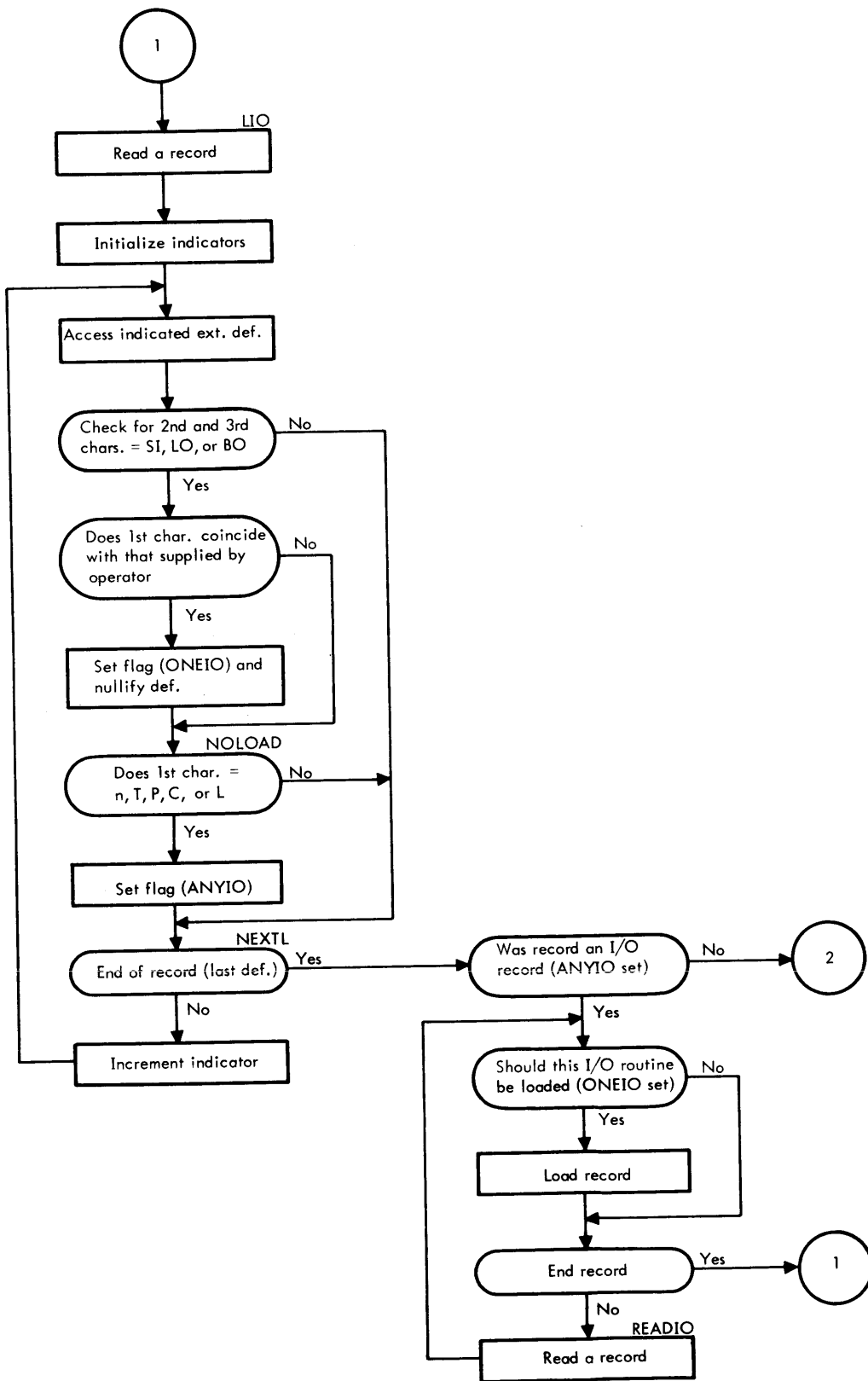

900 SERIES SYMBOL LOADER (cont.)

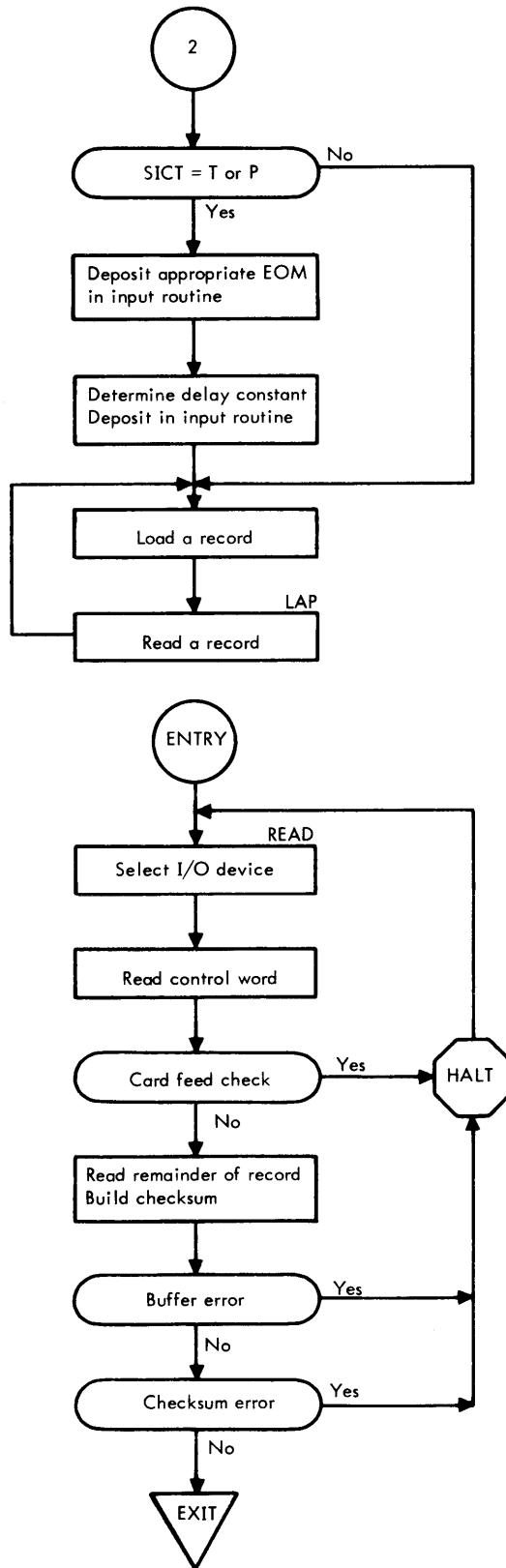

900 SERIES SYMBOL LOADER (cont.)

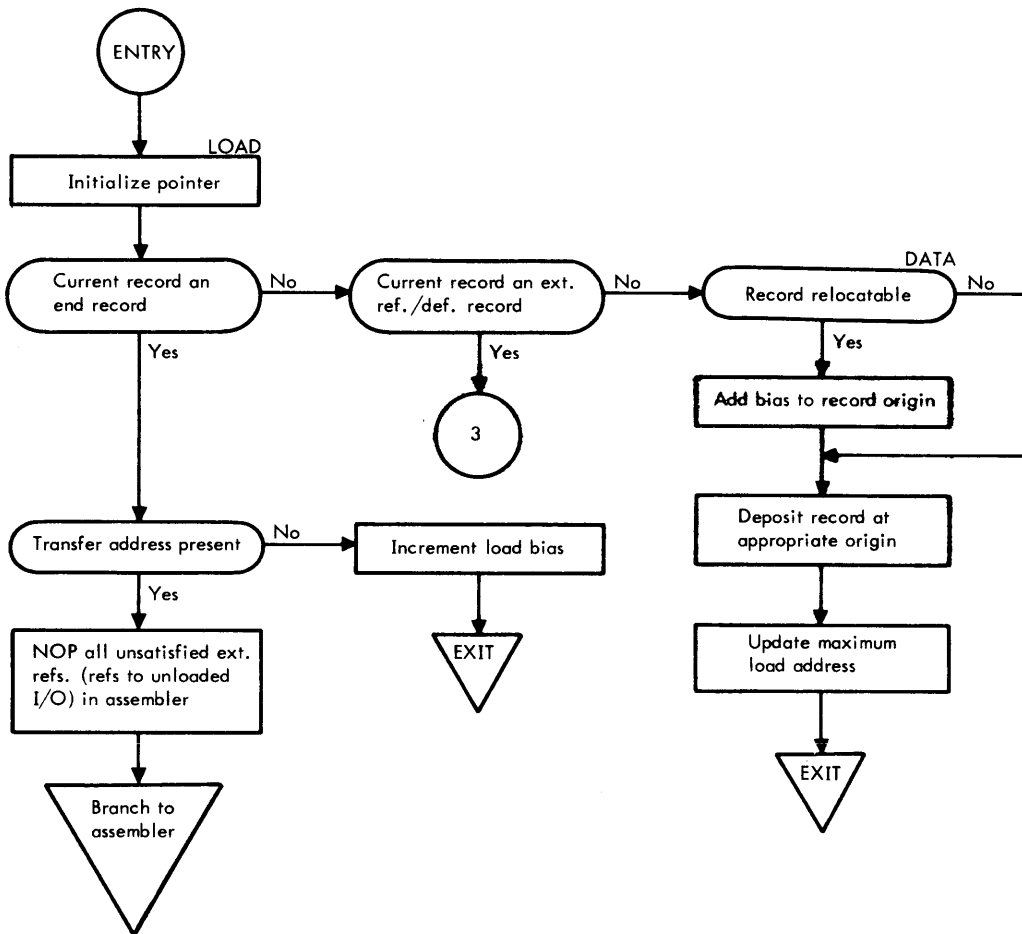

900 SERIES SYMBOL LOADER (cont.)

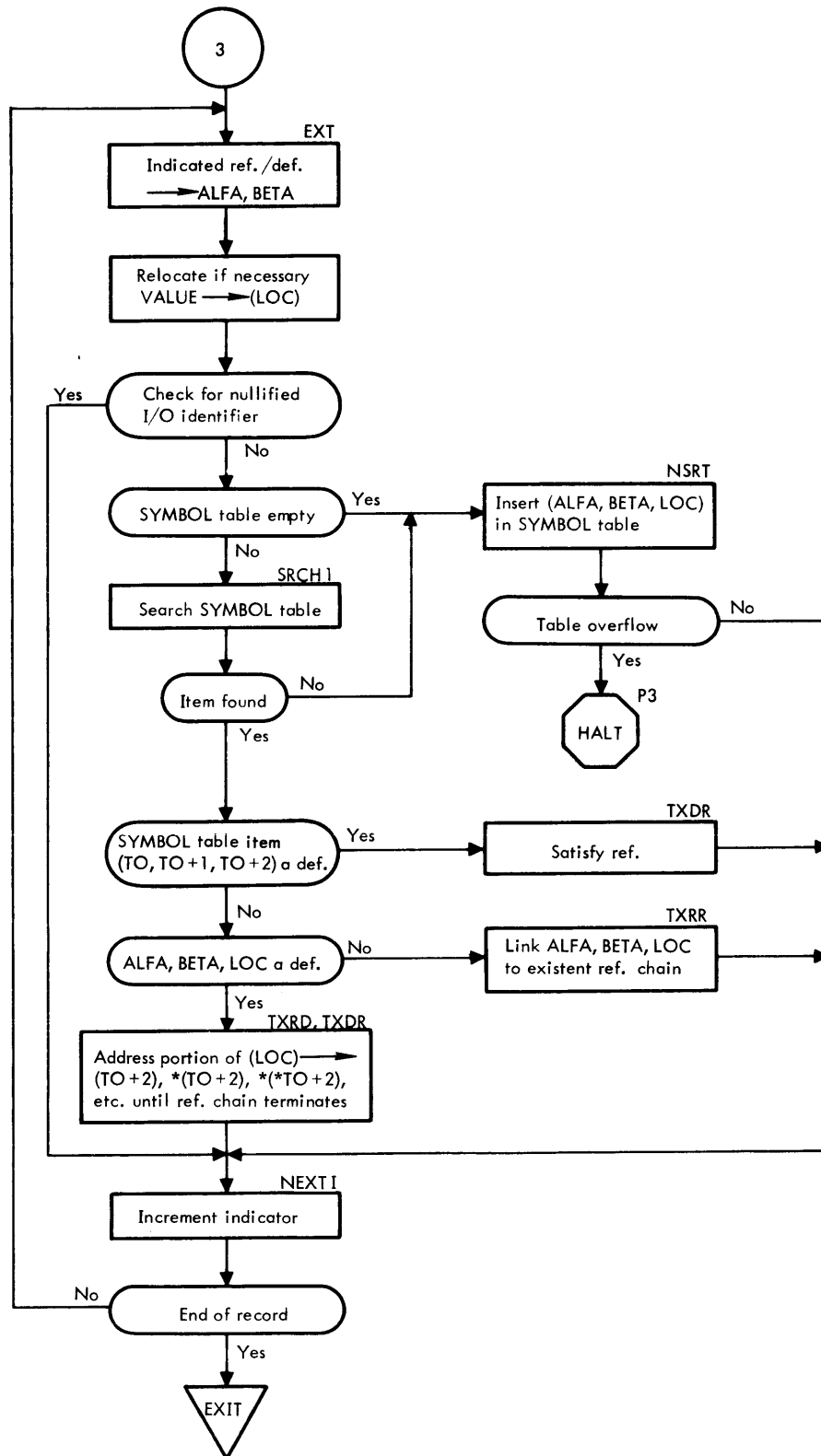

Δ ASSIGN SI CR EI CR L0 LP E0 CP B0 CP S MTO X1 MT1 X2 MT2.

Δ ASSIGN SI=CR,EI=CR,E0=CP,B0=PP,L0=LP.

Δ METASYM SI,L0,B0.

	03000		1	AORG	03000	
		00000000	2	S9300 EQU	0	
		00000000	3	X0 EQU	S9300	
		00000002	4	X2 EQU	2-S9300	
		00000000	5	CH EQU	0	
		00000001	6	U EQU	1	
	03000	0 75 0 03121	7	START LDB	=-1	COMPUTE MAXIMUM MEMORY ADDRESS
	03001	0 76 0 03122	8	LDA	=040000*/S9300+2047	
	03002	0 54 0 03123	9	LOOP1 SUB	=04000	
	03003	0 35 0 03113	10	STA	BIAS	
	03004	0 35 1 03113	11	STA	*BIAS	
	03005	0 70 1 03113	12	SKM	*BIAS	
	03006	0 01 0 03002	13	BRU	LOOP1	
	03007	0 54 0 03124	14	SUB	=4095	SUBTRACT 07777
	03010	0 35 0 03113	15	STA	BIAS	BIAS=MEMORY SIZE-4K
2-10	03011	0 40 21000	16	BPT BRTW		
	03012	0 01 0 03011	17	BRU	BPT	
	03013	0 40 20400	18	BPT	1	
	03014	0 01 0 03017	19	BRU	CARDS	
	03015	0 02 0 02604	20	RPT	CH,U,4	
	03016	0 01 0 03022	21	BRU	READ	
	03017	0 40 12006	22	CARDS CRT	CH,U	
	03020	0 01 0 03017	23	BRU	CARDS	
	03021	0 02 0 03606	24	RCB	CH,U,4	
	03022	0 32 0 03114	25	READ WIM	CW	CONTROL WORD
	03023	0 76 0 03114	26	LDA	CW	
	03024	0 02 20001	27	R0V		
	03025	0 6700 003	28	LSH	3	END RECORD TURNS ON OVERFLOW
	03026	0 6600 022	29	RSH	18	
	03027	0 35 0 03116	30	STA	COUNT	WORD COUNT
	03030	0 40 21000	31	BRTW		CHECK FOR CARD FEED ERROR
	03031	0 01 0 03033	32	BRU	\$+2	NO
	03032	0 01 0 03111	33	BRU	ERROR	YES
	03033	0 32 0 03115	34	WIM	L0C	RECORD ORIGIN
	03034	0 76 0 03115	35	LDA	L0C	

03035	0	72	0	03125	36	SKA	=01700000	IS RECORD RELOCATABLE
03036	0	55	0	03113	37	ADD	BIAS	YES
03037	0	40	20001		38	OVLT		NO. CHECK FOR END RECORD
03040	0	76	0	03112	39	LDA	BRUX*	YES
03041	0	35	0	03117	40	STA	T1	T1,T2 NOW POINT EITHER TO RECORD
03042	0	35	0	03120	41	STA	T2	ORIGIN OR TO EXIT
03043	0	76	0	03115	42	LDA	L0C	
03044	0	6600	023		43	RSH	19	(A)=1 IF REL WORD PRESENT
03045	0	55	0	03126	44	ADD	=00200001	COMPUTE XREG CONSTANT CORRESPONDING
03046	0	54	0	03116	45	SUB	COUNT	TO NUMBER OF DATA WORDS TO READ
03047	0	35	0	03116	46	STA	COUNT	
03050	0	76	0	03114	47	LDA	CW	BEGIN CHECKSUM
03051	0	17	0	03115	48	EOR	L0C	
03052	0	71	0	03116	49	LDX	COUNT,X0	
03053	0	01	0	03057	50	BRU	BRX1	
03054	0	32	1	03117	51	LOOP2 WIM	*T1	READ RECORD
03055	0	17	1	03117	52	EOR	*T1	
03056	0	61	0	03117	53	MIN	T1	
03057	0	41	0	03054	54	BRX1 BRX	LOOP2,X0	
03060	0	32	0	03114	55	WIM	REL	READ IN REL WORD IF ANY
03061	0	17	0	03114	56	EOR	REL	
03062	0	40	20400		57	BPT	1	
03063	0	02	0	12006	58	SRC	CH,U	
03064	0	40	20010		59	BETW		CHECK FOR BUFFER ERROR
03065	0	01	0	03111	60	BRU	ERROR	
03066	0	35	0	03115	61	STA	CS	FOLD CHECKSUM
03067	0	6600	014		62	RSH	12	
03070	0	17	0	03115	63	EOR	CS	
03071	0	75	0	03111	64	LDB	ERROR	
03072	0	70	0	03111	65	SKM	ERROR	
03073	0	01	0	03111	66	BRU	ERROR	CHECKSUM FAILS
03074	0	71	0	03116	67	LDX	COUNT,X0	
03075	0	75	0	03114	68	LDB	REL	
03076	0	01	0	03107	69	BRU	BRX2	
03077	0	36	0	03117	70	LOOP3 STB	T1	RELOCATION LOOP
03100	0	76	1	03120	71	LDA	*T2	
03101	0	55	0	03113	72	ADD	BIAS	
03102	0	53	0	03117	73	SKN	T1	
03103	0	01	0	03105	74	BRU	MIN	

03104	0 35 1 03120	75	STA	*T2
03105	0 61 0 03120	76	MIN	T2
03106	0 6700 001	77	LSH	1
03107	0 41 0 03077	78	BRX2	BRX
03110	0 01 0 03011	79	EXIT	BRU
03111	0 00 0 07777	80	ERR0R	HLT
03112	0 01 0 03110	81	BRUX	BRU
03113		82	BIAS	RES
03114		83	CW	RES
03115		84	L0C	RES
03116		85	C0UNT	RES
03117		86	T1	RES
03120		87	T2	RES
	00003114	88	REL	EQU
	00003115	89	CS	EQU
	00003000	90	END	START
03121	77777777			
03122	00043777			
03123	00004000			
03124	00007777			
03125	01700000			
03126	00200001			

		1 *	SYMBOL LOADER	
		2 *		
04000		3	ASRG	04000
	00000000	4 S9300	EQU	0
	00000000	5 X0	EQU	S9300
	00000002	6 X2	EQU	2-S9300
		7 CAB	0PD	04600004
		8 CBA	0PD	04600010
		9 CAX	0PD	04600400
		10 CXA	0PD	04600200
		11 CBX	0PD	04600020
		12 CNA	0PD	04601000
		13 SKE	0PD	05000000
		14 SKR	0PD	06000000
		15 MUL	0PD	06400000
		16 DIV	0PD	06500000
		17 ADM	0PD	06300000
		18 XMA	0PD	06200000
04000		19 SICT	RES	1
04001		20 B0CT	RES	1
04002		21 L0CT	RES	1
04003		22 0NEI0	RES	1
04004		23 ANYI0	RES	1
04005		24 SIC	RES	1
04006	00000000	25 PC	DATA	0
04007	00000000	26 PLC	DATA	0
04010	00000061	27 VCHR	DATA	'/'
04011	00000057	28 DCHR	DATA	'Δ'
04012	00177775	29 M3	DATA	00200000-3
04013	00177772	30 M6	DATA	00200000-6
04014	00004000	31 LSICT	DATA	SICT
04015	00004002	32 LL0CT	DATA	L0CT
04016	00000052	33 CR	DATA	052
04017	00000000	34 CHR	DATA	0
04020	00000044	35 DEVICE	DATA	'M','T','P','C','L'
04021	00000063			

1 FOR 900 SERIES

2-13

04022	00000047					
04023	00000023					
04024	00000043					
04025	62316060	36	FNCS	DATA	'SI 'B0 'L0 '	
04026	22466060					
04027	43466060					
04030	0 40 21000	37	STRT	BRTW		
04031	0 01 0 04030	38		BRU	STRT	
04032	0 02 0 02001	39		RKB	0,1,1	
04033	0 76 0 00160	40	RESET	LDA	Z	CLEAR I/O INDICATORS
04034	0 35 0 04000	41		STA	SICT	
04035	0 35 0 04001	42		STA	B0CT	
04036	0 35 0 04002	43		STA	L0CT	
04037	0 35 0 00044	44		STA	ML0C	
04040	0 76 0 04014	45		LDA	LSICT	
04041	0 35 0 04006	46		STA	PC	INITIALIZE POINTER
04042	0 75 0 00146	47		LDB	P63	
04043	0 32 0 04017	48	CIN	WIM	CHR	
04044	0 76 0 04017	49		LDA	CHR	
04045	0 70 0 04011	50		SKM	DCHR	WAIT FOR DELTA
04046	0 01 0 04043	51		BRU	CIN	
04047	0 32 0 04017	52	NXTCHR	WIM	CHR	
04050	0 76 0 04017	53		LDA	CHR	
04051	0 70 0 04010	54		SKM	VCHR	RESET UPON SLASH
04052	0 01 0 04054	55		BRU	\$+2	
04053	0 01 0 04033	56		BRU	RESET	
04054	0 70 0 04016	57		SKM	CR	FINISH UPON CARRIAGE RETURN
04055	0 01 0 04057	58		BRU	\$+2	
04056	0 01 0 04067	59		BRU	LOADIO	
04057	0 14 0 00146	60		ETR	P63	
04060	0 46 20005	61		ABC		
04061	0 76 0 04006	62		LDA	PC	
04062	0 73 0 04015	63		SKG	LL0CT	
04063	0 36 1 04006	64		STB	*PC	
04064	0 61 0 04006	65		MIN	PC	
04065	0 75 0 00146	66		LDB	P63	
04066	0 01 0 04047	67		BRU	NXTCHR	GET NEXT CHARACTER
04067	0 02 00000	68	LOADIO	DSC	0	
04070	0 75 0 00162	69		LDB	M1	COMPUTE MEMORY SIZE

04071	0	76	0	04263	70	LDA	BIGADR	18K FOR 900 SERIES, 34K FOR 9300
04072	0	54	0	04264	71	M2K SUB	B12	SUBTRACT
04073	0	35	0	00154	72	STA	HIGH	2K
04074	0	35	1	00154	73	STA	*HIGH	
04075	0	70	1	00154	74	SKM	*HIGH	SKIP WHEN FINISHED
04076	0	01	0	04072	75	BRU	M2K	
04077	0	40	20400		76	BPT	1	
04100	0	01	0	04102	77	BRU	EITHER	
					78	* BPT	2	REMOVE ASTERISK FROM MAG TAPE LOAD
					79	* BRU	EITHER	REMOVE ASTERISK FOR MAG TAPE LOAD
04101	0	01	0	04113	80	BRU	LI03	
04102	0	76	0	04106	81	EITHER LDA	SETUP	
04103	0	40	20200		82	BPT	2	
					83	* ADD	P5	REMOVE ASTERISK FROM MAG TAPE LOAD
04104	0	35	0	04106	84	STA	SETUP	
04105	0	71	0	04250	85	LDX	M4,X0	
04106	2	76	0	04242	86	SETUP LDA	CARDS+4,X2	
04107	2	35	0	00062	87	STA	READY+4,X2	
04110	0	41	0	04106	88	BRX	SETUP,X0	
04111	0	76	1	04106	89	LDA	*SETUP	
04112	0	35	0	00111	90	STA	BERR0R	
04113	0	60	0	04252	91	LI03 SKR	NEG	
04114	0	01	0	04126	92	BRU	LI0	910
04115	0	71	0	04251	93	LDX	LENGTH,X0	
04116	2	76	0	00435	94	LDA	END920,X2	
04117	2	35	0	00233	95	STA	END920-D,X2	
04120	0	41	0	04116	96	BRX	\$-2,X0	
04121	0	76	0	04253	97	LDA	NEWEND	
04122	0	60	0	04255	98	SKR	COMP93	TEST FOR 9300
04123	0	76	0	04262	99	LDA	ORG93	YES. ORIGIN 1/0 AT 3164
04124	0	35	0	00051	100	STA	BIAS	NO. ORIGIN 1/0 AT 0233
04125	0	35	0	04254	101	STA	NWBIAS	
04126	0	43	0	00055	102	LI0 BRM	READ	READ ONE RECORD (1ST EXTERNAL DEFS)
04127	0	76	0	00153	103	LDA	N1	RESET LOADING INDICATORS
04130	0	35	0	04003	104	STA	ONEI0	
04131	0	35	0	04004	105	STA	ANYI0	
04132	0	76	0	07773	106	LDA	LDW1	INITIALIZE POINTER
04133	0	35	0	00050	107	STA	WD1	
04134	0	76	0	00042	108	LDA	CT	

04135	0 35 0 04006	109	STA	PC	
04136	0 71 0 00050	110	LOOK LDX	WD1,X0	
04137	2 76 0 00000	111	LDA	0,X2	ACCESS EXTERNAL DEF
04140	2 75 0 00001	112	LDB	1,X2	
04141	0 6600 022	113	RSH	18	
04142	0 14 0 00146	114	ETR	P63	MOST SIGNIFICANT CHARACTER IN A 2ND,3RD CHARACTERS LEFT JUST. IN A
04143	0 46 00014	115	XAB		
04144	0 71 0 04250	116	LDX	M4,X0	
04145	0 36 0 04017	117	STB	CHR	
04146	0 75 0 00153	118	LDB	N1	
04147	0 41 0 04151	119	BRX	\$+2,X0	EXHAUST CHECK AFTER 3 ATTEMPTS
04150	0 01 0 04171	120	BRU	NEXTL	
04151	2 70 0 04030	121	SKM	FNCS+3,X2	CHECK FOR SI,B0 OR L0.
04152	0 01 0 04147	122	BRU	\$-3	NO
04153	0 76 0 04017	123	LDA	CHR	YES
04154	2 70 0 04003	124	SKM	SICT+3,X2	CHECK FOR COINCIDENCE OF 1ST CHAR
04155	0 01 0 04163	125	BRU	N0LOAD	NO
04156	0 76 0 00160	126	LDA	Z	YES
04157	0 71 0 00050	127	LDX	WD1,X0	DEF HAS SERVED ITS PURPOSE
04160	2 35 0 00000	128	STA	0,X2	CLEAR
04161	0 61 0 04003	129	MIN	0NEI0	FLAG TO LOAD
04162	0 76 0 04017	130	LDA	CHR	
04163	0 71 0 04013	131	N0LOAD LDX	M6,X0	DETERMINE WHETHER 1ST CHAR COINCIDES WITH ANY LEGITIMATE 1ST CHAR
04164	0 41 0 04166	132	BRX	\$+2,X0	
04165	0 01 0 04171	133	BRU	NEXTL	
04166	2 70 0 04025	134	SKM	DEVICE+5,X2	
04167	0 01 0 04164	135	BRU	\$-3	
04170	0 61 0 04004	136	MIN	ANYI0	IF S0, MAKE INDICATOR POSITIVE
04171	0 76 0 07642	137	NEXTL LDA	P3	ADVANCE POINTER TO NEXT EXTERNAL DEF
04172	0 55 0 00050	138	ADD	WD1	
04173	0 35 0 00050	139	STA	WD1	
04174	0 76 0 04006	140	LDA	PC	CHECK FOR END OF RECORD
04175	0 54 0 07642	141	SUB	P3	
04176	0 35 0 04006	142	STA	PC	
04177	0 73 0 00160	143	SKG	Z	
04200	0 01 0 04202	144	BRU	\$+2	YES
04201	0 01 0 04136	145	BRU	LOOK	NO. ACCESS NEXT DEF
04202	0 53 0 04004	146	SKN	ANYI0	IF ANYI0 STILL NEG, RECORD NOT I/O
04203	0 01 0 04206	147	BRU	\$+3	STILL I/O

04204	0 01 0	04214	148	BRU	FINIO	
04205	0 43 0	00055	149	READIO	BRM	READ
04206	0 53 0	04003	150		SKN	ONEIO
04207	0 43 0	00123	151		BRM	LOAD
04210	0 76 0	00002	152		LDA	CW
04211	0 72 0	00152	153		SKA	P2B21
04212	0 01 0	04126	154		BRU	LI0
04213	0 01 0	04205	155		BRU	READIO
04214	0 76 0	04000	156	FINIO	LDA	SICT
04215	0 70 0	04021	157		SKM	DEVICE+1
04216	0 01 0	04220	158		BRU	\$+2
04217	0 01 0	04224	159		BRU	STEOM
04220	0 70 0	04022	160		SKM	DEVICE+2
04221	0 01 0	00053	161		BRU	LAP+1
04222	0 76 0	04256	162		LDA	RPT
04223	0 01 0	04225	163		BRU	\$+2
04224	0 76 0	04257	164	STEOM	LDA	RKE
04225	0 35 1	04254	165		STA	*NWBIAS
04226	0 61 0	04254	166		MIN	NWBIAS
04227	0 76 0	07774	167		LDA	P2
04230	0 6600	100	168		RSH	64
04231	0 75 0	04261	169		LDB	SLOW
04232	0 73 0	00160	170		SKG	Z
04233	0 75 0	04260	171		LDB	FAST
04234	0 36 1	04254	172		STB	*NWBIAS
04235	0 01 0	00053	173		BRU	LAP+1
04236	0 40	12006	174	CARDS	CRT	0,1
04237	0 01 0	00056	175		BRU	READY
04240	0 20 0	00000	176		NOP	
04241	0 02 0	03606	177		RCB	0,1,4
04242	0 01 0	00121	178		BRU	P1
04243	0 40	10410	179		TRT	0,0
04244	0 40	21000	180		BRTW	
04245	0 01 0	00056	181		BRU	READY
04246	0 02 0	03610	182		RTB	0,0,4
			183	*	BRU	RECOV
04247	00000005		184	P5	DATA	5
04250	00177774		185	M4	DATA	00200000-4
04251	00177731		186	LENGTH	DATA	00200000-END920+PJP920

DO NOT LOAD IF ONEIO STILL NEGATIVE

CHECK FOR END RECORD

NO

T
CHECK FOR PAPER TAPE
OR TYPEWRITER INPLT

P

DETERMINE CYCLE TIME OF MACHINE
FOR PAPER TAPE READ DELAY

REMOVE ASTERISK FOR MAG TAPE LOAD

04252	77777777	187	NEG	DATA	-1	
04253	0 00 0 00233	188	NEWEND	HLT	END920-D	
04254	0 00 0 00366	189	NWBIAS	HLT	ENDP0P	
04255	0 00 0 00000	190	COMP93	HLT	S9300	
04256	0 02 0 02004	191	RPT	RPT	0,1,1	
04257	0 02 0 02001	192	RKB	RKB	0,1,1	
04260	00140000	193	FAST	DATA	00140000	
04261	00170000	194	SLOW	DATA	00170000	
04262	0 00 0 00161	195	ORG93	HLT	Z+1	
04263	00043777	196	BIGADR	DATA	040000*/S9300+2047	
04264	00004000	197	B12	DATA	2048	
00001		198		ABRG	1	
00001	0 01 0 04030	199		BRU	STRT	
00002		200	CW	RES	1	
00003		201	DW1	RES	26	
00035		202	TMP1	RES	1	
00036		203	IWD	RES	1	
00037		204	RCTR	RES	1	
00040		205	CTR	RES	1	
00041		206	WDCT	RES	1	
00042		207	CT	RES	1	
00043		208	L0C	RES	1	
00044		209	ML0C	RES	1	
00045		210	ALFA	RES	1	
00046		211	BETA	RES	1	
00047		212	CHAIN	RES	1	
00050		213	WD1	RES	1	
00051	0 00 0 00366	214	BIAS	HLT	ENDP0P	
00052	0 43 0 00055	215	LAP	BRM	READ	
00053	0 43 0 00123	216		BRM	LOAD	
00054	0 01 0 00052	217		BRU	LAP	
		218	*		READ ONE RECORD FROM PAPER TAPE AND VERIFY	
		219	*			
00055	0 00 0 00000	220	READ	HLT	ENTRY	
		221	*	LDX	M10,XO	REMOVE ASTERISK FROM MAG TAPE LOAD
		222	*	STX	WD1,XO	REMOVE ASTERISK FROM MAG TAPE LOAD
00056	0 20 0 00000	223	READY	N0P		
00057	0 20 0 00000	224		N0P		
00060	0 20 0 00000	225		N0P		

00061	0 02 0 02604	226	RPT	0,1,4	
00062	0 32 0 00002	227	WIM	CW	READ RECORD CONTROL WORD
00063	0 40 21000	228	BRTW		
00064	0 01 0 00066	229	BRU	\$+2	
00065	0 01 0 00111	230	BRU	BERROR	
00066	0 76 0 00002	231	LDA	CW	
00067	0 6600 017	232	RSH	15	
00070	0 14 0 00146	233	ETR	P63	
00071	0 54 0 07774	234	SUB	P2	
00072	0 35 0 00041	235	STA	WDCT	STORE WORD COUNT LESS 2
00073	0 35 0 00042	236	STA	CT	
00074	0 76 0 07773	237	LDA	LDW1	
00075	0 35 0 07775	238	STA	WDAD	
00076	0 76 0 00002	239	LDA	CW	
00077	0 32 1 07775	240	READ3 WIM	*WDAD	READ ONE WORD
00100	0 17 1 07775	241	EOR	*WDAD	ACCUMULATE CHECKSUM
00101	0 60 0 00041	242	SKR	WDCT	
00102	0 61 0 07775	243	MIN	WDAD	
00103	0 53 0 00041	244	SKN	WDCT	
00104	0 01 0 00077	245	BRU	READ3	
00105	0 32 0 00035	246	WIM	TMP1	EXHAUST RECORD
00106	0 40 21000	247	BRTW		
00107	0 01 0 00105	248	BRU	\$-2	
00110	0 40 20010	249	BETW		
00111	0 01 0 00121	250	BERROR BRU	P1	
00112	0 35 0 00035	251	STA	TMP1	
00113	0 6600 014	252	RSH	12	
00114	0 17 0 00035	253	EOR	TMP1	
00115	0 75 0 07772	254	LDB	07777	
00116	0 70 0 00041	255	SKM	WDCT	
00117	0 01 0 00111	256	BRU	BERROR	
00120	0 51 0 00055	257	BRR	READ	
		258	*REINSTATE	FOLLOWING CODE FOR MAG TAPE LOAD	
		259	*RECOV TRT	0,0	
		260	* BRTW		
		261	* BRU	\$-2	
		262	* SRB	0,0,4	
		263	* BRTW		
		264	* BRU	\$-1	

		265 *	LDX	WD1,X0	
		266 *	BRX	READ+1,X0	
00121	0 00 0 00001	267 P1	HLT	1	*STOP*ΔW BUFFER ERROR
00122	0 01 0 00056	268	BRU	READ+1	REREAD
		269 *M10	DATA	00200000-10	REMOVE ASTERISK FOR MAG TAPE
		270 *		PROCESS VERIFIED RECORDS	
00123	0 00 0 00000	271 LOAD	HLT		ENTRY
00124	0 76 0 07773	272	LDA	LDW1	
00125	0 35 0 00050	273	STA	WD1	
00126	0 76 0 00002	274	LDA	CW	
00127	0 72 0 00152	275	SKA	P2B21	
00130	0 01 0 00134	276	BRU	END	
00131	0 72 0 00151	277	SKA	P1B21	
00132	0 01 0 07661	278	BRU	EXT	
00133	0 01 0 07571	279 LTO	BRU	DATA	USED AS CONSTANT
00134	0 76 0 00042	280 END	LDA	CT	
00135	0 72 0 00153	281	SKA	N1	TRANSFER ADDRESS
00136	0 01 0 07747	282	BRU	NOPS	YES
00137	0 76 0 00003	283	LDA	DW1	NO
00140	0 72 0 00147	284	SKA	P1B15	
00141	0 55 0 00051	285	ADD	BIAS	
00142	0 14 0 00155	286	ETR	MADR	
00143	0 35 0 00043	287	STA	L0C	MAX LOCATION+1, CURRENT PROGRAM
00144	0 35 0 00051	288	STA	BIAS	
00145	0 51 0 00123	289	BRR	LOAD	
00146	00000077	290 P63	DATA	077	
00147	00100000	291 P1B15	DATA	01000000	
00150	02000000	292 P2B18	DATA	02000000	
00151	10000000	293 P1B21	DATA	010000000	
00152	20000000	294 P2B21	DATA	020000000	
00153	77777777	295 N1	DATA	077777777	
	00037777	296 ADDR	EQU	1*/(14+S9300)-1	
00154		297 HIGH	RES	1	MUST BE AT ASME L0C(0154) AS FOR ASSM
00155	00037777	298 MADR	DATA	ADER	
00156	77740000	299 MRDA	DATA	-1--ADDR	
00157	00177775	300 TL	DATA	00200000-3	
00160	00000000	301 Z	DATA	0	
00161	40000000	302 B0	DATA	040000000	
00162	77777777	303 M1	DATA	-1	

00163	77777751	304	M23	DATA	-23
		305	MM0	0PD	06000000
00164		306	P0P910	RES	0
00164	0 01 0 00200	307		BRU	CAB
00165	0 01 0 00202	308		BRU	CBA
00166	0 01 0 00320	309		BRU	CAX
00167	0 01 0 00315	310		BRU	CXA
00170	0 01 0 00323	311		BRU	CBX
00171	0 01 0 00325	312		BRU	CNA
00172	0 01 0 00342	313		BRU	SKF
00173	0 01 0 00351	314		BRU	SKR
00174	0 01 0 00204	315		BRU	MUL
00175	0 01 0 00225	316		BRU	DIV
00176	0 01 0 00337	317		BRU	ADM
00177	0 01 0 00330	318		BRU	XMA
00200	0 35 0 00361	319	CAB	STA	T
00201	0 01 0 00347	320		BRU	SKE1
00202	0 36 0 00361	321	CBA	STB	T
00203	0 01 0 00316	322		BRU	CXA1
00204	0 75 0 00160	323	MUL	LDB	Z
00205	0 43 0 00257	324		BRM	SIGN
00206	0 46 20005	325		ABC	
00207	0 6620 001	326	MUL1	RCY	1
00210	0 35 0 00363	327		STA	T+2
00211	0 6720 001	328		LCY	1
00212	0 53 0 00363	329		SKN	T+2
00213	0 01 0 00215	330		BRU	\$+2
00214	0 55 0 00362	331		ADD	T+1
00215	0 6600 001	332		RSH	1
00216	0 14 0 00357	333		ETR	RSL4
00217	0 41 0 00207	334		BRX	MUL1
00220	0 53 0 00360	335		SKN	S
00221	0 01 0 00223	336		BRU	MJI 2
00222	0 43 0 00300	337		BRM	DPN
00223	0 71 0 00361	338	MUL2	LDX	T
00224	0 51 0 00000	339		BRP	0
00225	0 43 0 00257	340	DIV	BRM	SIGN
00226	0 73 0 00362	341		SKG	T+1
00227	0 01 0 00231	342		BRU	\$+2

00230	4 51 0 00230	343	BRR	\$,4
00231	0 6720 001	344	DIV2 LCY	1
00232	0 54 0 00362	345	SUB	T+1
00233	0 17 0 00161	346	EOR	B0
00234	0 72 0 00161	347	SKA	B0
00235	0 01 0 00240	348	BRU	DIV1
00236	0 17 0 00161	349	EOR	B0
00237	0 55 0 00362	350	ADD	T+1
00240	0 41 0 00231	351	DIV1 BRX	DIV2
00241	0 6720 001	352	LCY	1
00242	0 36 0 00362	353	STB	T+1
00243	0 14 0 00357	354	ETR	RSL4
00244	0 6600 031	355	RSH	25
00245	0 76 0 00362	356	LDA	T+1
00246	0 53 0 00360	357	SKN	S
00247	0 01 0 00223	358	BRU	MUL2
00250	0 17 0 00162	359	EOR	M1
00251	0 54 0 00162	360	SUB	M1
00252	0 46 00014	361	XAB	
00253	0 17 0 00162	362	EOR	M1
00254	0 54 0 00162	363	SUB	M1
00255	0 46 00014	364	XAB	
00256	0 01 0 00223	365	BRU	MUL2
00257	0 00 0 00000	366	SIGN HLT	0
00260	0 35 0 00363	367	STA	T+2
00261	0 17 1 00000	368	EOR	*0
00262	0 35 0 00360	369	STA	S
00263	0 17 0 00363	370	EOR	T+2
00264	0 53 1 00000	371	SKN	*0
00265	0 01 0 00270	372	BRU	SIGN1
00266	0 17 0 00162	373	EOR	M1
00267	0 54 0 00162	374	SUB	M1
00270	0 35 0 00362	375	SIGN1 STA	T+1
00271	0 76 0 00363	376	LDA	T+2
00272	0 53 0 00363	377	SKN	T+2
00273	0 01 0 00275	378	BRU	SIGN2
00274	0 43 0 00300	379	BRM	DPN
00275	0 37 0 00361	380	SIGN2 STX	T
00276	0 71 0 00163	381	LDX	M23

00277	0	51	0	00257	382	BRR	SIGN
00300	0	00	0	00000	383	DPN	0
00301	0	46	00014	384		XAB	
00302	0	17	0	00162	385		EOR
00303	0	54	0	00162	386		SUB
00304	0	35	0	00364	387		STA
00305	0	36	0	00365	388		STB
00306	0	46	20005	389		ABC	
00307	0	76	0	00162	390		LDA
00310	0	72	0	00364	391		SKA
00311	0	01	0	00313	392		BRU
00312	0	76	0	00160	393		LDA
00313	0	54	0	00365	394	DPN1	SUB
00314	0	51	0	00300	395		BRR
00315	0	37	0	00361	396	CXA	STX
00316	0	76	0	00361	397	CXA1	LDA
00317	0	51	0	00000	398		BRR
00320	0	35	0	00361	399	CAX	STA
00321	0	71	0	00361	400	CAX1	LDX
00322	0	51	0	00000	401		BRR
00323	0	36	0	00361	402	CBX	STB
00324	0	01	0	00321	403		BRU
00325	0	17	0	00162	404	CNA	EOR
00326	0	54	0	00162	405		SUB
00327	0	51	0	00000	406		BRR
00330	0	35	0	00362	407	XMA	STA
00331	0	76	1	00000	408		LDA
00332	0	35	0	00361	409		STA
00333	0	76	0	00362	410		LDA
00334	0	35	1	00000	411	XMA1	STA
00335	0	76	0	00361	412		LDA
00336	0	51	0	00000	413		BRR
00337	0	35	0	00361	414	ADM	STA
00340	0	55	1	00000	415		ADD
00341	0	01	0	00334	416		BRU
00342	0	36	0	00361	417	SKE	STB
00343	0	75	0	00162	418		LDB
00344	0	70	1	00000	419		SKM
00345	0	01	0	00347	420		BRU

00346	0	61	0	00000	421	MIN	0
00347	0	75	0	00361	422	SKE1 LDB	T
00350	0	51	0	00000	423	BRR	0
00351	0	60	1	00000	424	SKR MM0	*0
00352	0	20	0	00000	425	N0P	0
00353	0	53	1	00000	426	SKN	*0
00354	0	51	0	00000	427	BRR	0
00355	0	61	0	00000	428	MIN	0
00356	0	51	0	00000	429	BRR	0
00357	3	7	7	7777	430	RSL4 DATA	037777777
00360					431	S RES	1
00361					432	T RES	5
00366					433	ENDP0P RES	0
00366					434	P0P920 RES	0
	0	0	0	00000202	435	D EQU	P0P920-P0P910
00366	0	01	0	00200	436	BRU	CAB920-D
00367	0	01	0	00202	437	BRU	CBA920-D
00370	0	01	0	00204	438	BRU	CAX920-D
00371	0	01	0	00206	439	BRU	CXA920-D
00372	0	01	0	00210	440	BRU	CBX920-D
00373	0	01	0	00212	441	BRU	CNA920-D
00374	0	01	0	00214	442	BRU	SKE920-D
00375	0	01	0	00220	443	BRU	SKR920-D
00376	0	01	0	00223	444	BRU	MUL920-D
00377	0	01	0	00225	445	BRU	DIV920-D
00400	0	01	0	00227	446	BRU	ADM920-D
00401	0	01	0	00231	447	BRU	XMA920-D
00402	0	46	0	00004	448	CAB920 CAB	
00403	0	51	0	00000	449	BRR	0
00404	0	46	0	00010	450	CBA920 CBA	
00405	0	51	0	00000	451	BRR	0
00406	0	46	0	00400	452	CAX920 CAX	
00407	0	51	0	00000	453	BRR	0
00410	0	46	0	00200	454	CXA920 CXA	
00411	0	51	0	00000	455	BRR	0
00412	0	46	0	00020	456	CBX920 CBX	
00413	0	51	0	00000	457	BRR	0
00414	0	46	0	01000	458	CNA920 CNA	
00415	0	51	0	00000	459	BRR	0

00416	0 50 1 00000	460	SKE920	SKE	*0	
00417	0 51 0 00000	461		BRR	0	
00420	0 61 0 00000	462	SKIP2	MIN	0	
00421	0 51 0 00000	463		BRR	0	
00422	0 60 1 00000	464	SKR920	SKR	*0	
00423	0 51 0 00000	465		BRR	0	
00424	0 01 0 00216	466		BRU	SKIP2-D	
00425	0 64 1 00000	467	MUL920	MUL	*0	
00426	0 51 0 00000	468		BRR	0	
00427	0 65 1 00000	469	DIV920	DIV	*0	
00430	0 51 0 00000	470		BRR	0	
00431	0 63 1 00000	471	ADM920	ADM	*0	
00432	0 51 0 00000	472		BRR	0	
00433	0 62 1 00000	473	XMA920	XMA	*0	
00434	0 51 0 00000	474		BRR	0	
00435		475	END920	RES	0	
07567		476		RORG	07567	
07566		477		RORG	07566	
		478	F	FORM	3,6,15	
		479		TEXT	8,Z	
07566	71606060					
07567	60606060					
07570	4 00 00160	480		F	4,0,Z	
07571		481	T0	RES	0	
		482	*		PROCESS DATA RECORD	
07571	0 71 0 00042	483	DATA	LDX	CT,X0	
07572	0 46 30003	484		CLR		
07573	0 76 0 00003	485		LDA	DW1	
07574	0 72 0 00150	486		SKA	P2B18	
07575	2 75 0 00003	487		LDB	DW1,X2	
07576	0 72 0 00150	488		SKA	P2B18	
07577	0 60 0 00042	489		SKR	CT	SUBTRACT RELOCATION WORD
07600	0 72 0 00147	490		SKA	P1B15	
07601	0 55 0 00051	491		ADD	BIAS	
07602	0 14 0 00155	492		ETR	MADR	
07603	0 35 0 00043	493		STA	L0C	STORE MODIFIED LOAD ADDRESS
		494	*		PROCESS DATA WORDS	
07604	0 60 0 00042	495		SKR	CT	(CT) = NO. DATA WORDS - 1
07605	0 76 0 07776	496		LDA	LDW2	
07606	0 35 0 00036	497		STA	IWD	INDIRECT ADDRESS OF 1ST DATA WORD

2-25

07607	0 76 1 00036	498 *			
07610	0 36 0 00045	499 LLDA	LDA	*IWD	(A) = CURRENT DATA WORD
07611	0 53 0 00045	500	STB	ALFA	
07612	0 01 0 07614	501	SKN	ALFA	
07613	0 55 0 00051	502	BRU	\$+2	
07614	0 35 1 00043	503	ADD	BIAS	
07615	0 61 0 00043	504	STA	*L0C	
07616	0 61 0 00036	505	MIN	L0C	INCREMENT LOAD ADDRESS
07617	0 60 0 00042	506	MIN	IWD	INCREMENT DATA WORD ADDRESS
07620	0 6700 001	507	SKR	CT	
07621	0 53 0 00042	508	LSH	1	
07622	0 01 0 07607	509	SKN	CT	
		510	BRU	LLDA	
		511 *			
07623	0 76 0 00044	512	LDA	ML0C	
07624	0 73 0 00043	513	SKG	L0C	
07625	0 76 0 00043	514	LDA	L0C	
07626	0 35 0 00044	515	STA	ML0C	STORE CURRENT MAXIMUM LOAD ADDRESS +1
07627	0 51 0 00123	516	BRR	LOAD	EXIT
		517 *			
		518 *			ROUTINES FOR PROCESSING EXTERNAL REFS AND DEFS
		519 *			(RECORD TYPE 1)
		520 *			MATCHING TABLE ENTRY WAA A DEF
07630	0 76 0 00045	521 SRCH2	LDA	ALFA	
07631	0 41 0 07632	522 SRCH3	BRX	\$+1,X0	
07632	0 41 0 07677	523	BRX	SRCH1,X0	
07633	0 76 0 00157	524 NSRT	LDA	TL	
07634	0 54 0 07642	525	SUB	P3	
07635	0 35 0 00157	526	STA	TL	
07636	0 71 0 00157	527	LDX	TL,X0	
07637	0 55 0 00133	528	ADD	LT0	
07640	0 14 0 00155	529	ETR	MADR	
07641	0 73 0 00044	530	SKG	ML0C	
07642	00000003	531 P3	DATA	3	
07643	0 76 0 00045	532	LDA	ALFA	
07644	2 35 0 07571	533	STA	T0,X2	
07645	0 75 0 00046	534	LDB	BETA	
07646	2 36 0 07572	535	STB	T0+1,X2	
07647	0 76 0 00043	536	LDA	L0C	

2-26

07650	2	35	0	07573	537	STA	T0+2,X2	
07651	0	76	0	07642	538	NEXTI LDA	P3	
07652	0	55	0	00050	539	ADD	WD1	
07653	0	35	0	00050	540	STA	WD1	
07654	0	76	0	00042	541	LDA	CT	
07655	0	54	0	07642	542	SUB	P3	
07656	0	35	0	00042	543	STA	CT	REDUCE WORD COUNT
07657	0	73	0	00160	544	SKG	Z	SKIP IF AT LEAST 3 MORE WORDS
07660	0	51	0	00123	545	BRR	LOAD	EXIT
					546	*		
					547	*	PROCESS NEXT ITEM, HEREAFTER CALLED 'C'	
07661	0	71	0	00050	548	EXT LDX	WD1,X0	(X0) = LOC. OF 1ST WORD OF LABEL
07662	2	76	0	00002	549	LDA	2,X2	(B) = CHAIN WORD OR VALUE WORD
07663	0	72	0	00147	550	SKA	P1B15	
07664	0	55	0	00051	551	ADD	BIAS	
07665	0	35	0	00043	552	STA	L0C	
07666	2	76	0	00000	553	LDA	0,X2	
07667	0	72	0	00162	554	SKA	M1	TEST FOR SPECIAL I/O IDENTIFIER
07670	0	01	0	07672	555	BRU	\$+2	NO
07671	0	01	0	07651	556	BRU	NEXTI	YES. IGNORE
07672	2	75	0	00001	557	LDB	1,X2	(AB) = 8 CHAR LABEL OF C
					558	*		
					559	*	PROCESS EXTERNAL DEF OR REF	
07673	0	71	0	00157	560	LDX	TL,X0	SEARCH SYMBOL TABLE
07674	0	35	0	00045	561	STA	ALFA	
07675	0	36	0	00046	562	STB	BETA	
07676	0	75	0	00153	563	LDB	N1	
07677	2	70	0	07571	564	SRCH1 SKM	T0,X2	
07700	0	41	0	07631	565	BRX	SRCH3,X0	NO MATCH
07701	0	76	0	00046	566	LDA	BETA	TENTATIVE MATHC
07702	2	70	0	07572	567	SKM	T0+1,X2	
07703	0	41	0	07630	568	BRX	SRCH2,X0	
07704	0	76	0	00043	569	LDA	L0C	
07705	2	53	0	07573	570	SKN	T0+2,X2	
07706	0	01	0	07710	571	BRU	\$+2	
07707	0	01	0	07715	572	BRU	1XDR	X IS A DEF
07710	0	53	0	00043	573	SKN	L0C	
07711	0	01	0	07731	574	BRU	1XRR	C IS A REF
07712	2	75	0	07573	575	LDB	T0+2,X2	

07713	0	46	00014	576	XAB		
07714	2	36	0 07573	577	STB	T0+2,X2	
07715	0	14	0 00155	578	TXDR	ETR	MADR
07716	0	35	0 00047	579	TXRD1	STA	CHAIN
07717	0	76	1 00047	580	LDA	*CHAIN	ADDR OF A REF
07720	2	17	0 07573	581	EOR	T0+2,X2	
07721	0	14	0 00156	582	ETR	MRDA	
07722	2	17	0 07573	583	EOR	T0+2,X2	
07723	0	75	1 00047	584	LDB	*CHAIN	
07724	0	46	00014	585	XAB		
07725	0	36	1 00047	586	STB	*CHAIN	
07726	0	72	0 00155	587	SKA	MADR	
07727	0	01	0 07715	588	BRU	TXDR	
07730	0	01	0 07651	589	BRU	NEXTI	EXIT 1
				590	*	X AND C ARE BOTH REFS	
07731	0	14	0 00155	591	TXRR	ETR	MADR
07732	0	35	0 00047	592	TXRR1	STA	CHAIN
07733	0	76	1 00047	593	LDA	*CHAIN	ADDRESS OF 1ST REF IN NEW CHAIN
07734	0	14	0 00155	594	ETR	MADR	
07735	0	72	0 00155	595	SKA	MADR	
07736	0	01	0 07732	596	BRU	TXRR1	
07737	0	76	0 00043	597	LDA	L0C	NEW 1ST LINK
07740	2	75	0 07573	598	LDB	T0+2,X2	
07741	0	46	00014	599	XAB		
07742	2	36	0 07573	600	STB	T0+2,X2	
07743	0	14	0 00155	601	ETR	MADR	REMOVE REF FLAG FROM OLD 1ST LINK
07744	0	55	1 00047	602	ADD	*CHAIN	
07745	0	35	1 00047	603	STA	*CHAIN	
07746	0	01	0 07651	604	BRU	NEXTI	EXIT 3
07747	0	20	0 00000	605	N0PS	N0P	
07750	0	75	0 07747	606	LDB	N0PS	
07751	0	71	0 00157	607	LDX	TL,X0	BE TO I/O ROUTINES
07752	2	77	0 00002	608	EAX	2,X2	
07753	2	53	0 07571	609	POINT	SKN	T0,X2
07754	0	01	0 07757	610	BRU	\$+3	REF
07755	0	41	0 07752	611	ADV	BRX	N0PS+3,X0
07756	0	01	0 00004	612	BRU	CW+2	DEF
07757	0	76	0 07753	613	LDA	POINT	FINISHED. BRANCH TO START
07760	0	35	0 00045	614	STA	ALFA	

07761	0	35	0	00046	615	STEP	STA	BETA	N9P REF CHAIN
07762	0	76	1	00046	616		LDA	*BETA	
07763	0	14	0	00155	617		ETR	MADR	
07764	0	35	0	00045	618		STA	ALFA	
07765	0	36	1	00046	619		STB	*BETA	
07766	0	76	0	00045	620		LDA	ALFA	
07767	0	72	0	00155	621		SKA	MADR	CHECK FOR END OF CHAIN
07770	0	01	0	07761	622		BRU	STEP	NO
07771	0	01	0	07755	623		BRU	ADV	YES
07772	0000	7777			624	07777	DATA	07777	
07773	0	00	0	00003	625	LDW1	HLT	DW1	
07774	00000000	2			626	P2	DATA	2	
07775	0	00	0	00003	627	WDAD	HLT	DW1	
07776	0	00	0	00004	628	LDW2	HLT	DW1+1	
	00004030				629	END	END	STRT	

**SDS PROGRAM LIBRARY
PROGRAM DESCRIPTION**

Page 1 of 2

Catalog No. 020024

IDENTIFICATION: 900 Series SYMBOL Paper Tape Reader or Typewriter
Symbolic Input Subroutine - PSI, TSI

AUTHOR: SDS

ACCEPTED: January 7, 1965

COMPUTER
CONFIGURATION: Any SDS 900 series computer with Paper Tape Reader
(Typewriter).

PURPOSE: To read one symbolic input record from the paper tape
reader (typewriter).

PROGRAMMED
OPERATORS: None

STORAGE: 0101 locations including constants

TIMING: N/A

USE: The subroutine is selectively loaded by the SYMBOL Loader
under operator control.

The subroutine has two entry points:

INPUT Read one BCD symbolic input record
into the area beginning at CBFE.

ENDSI End of symbolic input action subroutine.
The computer halts to facilitate the
reloading of paper tape.

Buffer and unit independence is an easily modified assembly
parameter.

Because of the similarity of paper tape and typewriter
input, the same subroutine is used in both cases. The
determination of the appropriate device EOM (RPT or RKB)

USE: (Cont)

is made by the SYMBOL Loader and conveyed to the input subroutine together with an appropriate delay constant (for delay between reading symbolic input records).

RECOVERY:

Upon detection of a buffer error, the subroutine will halt in relative location 032. In order to continue, one can branch to relative location 025 (P-6); to reread the record, one must reposition the paper tape and branch to relative location 3 (P-030).

00000		1 *	ΔP		
00000		2 \$PSI	RES	0	
		3 \$TSI	RES	0	
		4 *		SUBROUTINE TO READ SYMBOLIC INPUT FROM PAPER TAPE	
	00000000	5 S9300	EQU	0	1 FOR 900 SERIES
	00000000	6 X0	EQU	S9300	
	00000002	7 X2	EQU	2-S9300	
	00000000	8 CH	EQU	0	
	00000001	9 U	EQU	1	
		10 MM0	0PD	06000000	
		11 EDF	FORM	9,15	
		12 E0M	DATA	0	READ E0M AND DELAY DETERMINED BY
		13 DELAY	DATA	0	LJADER AND STORED HERE
		14 \$INPUT	RES	0	
		15 RDPT	PZE	0	
		16	LDX	=00200000-20,X0	
		17	LDB	=060606060	
		18 RDPT1	STB	CBFE,X2	CLEAR LINE IMAGE
		19	BRX	RDPT1,X0	
		20	LDX	DELAY,X0	
		21	BRX	\$,X0	
		22	LDA	EDWL	
		23	STA	TEMP+1	
		24	LDA	LCBUF	
		25 RDPT10	BRM	EDS	SET EDIT FIELD
		26	EXU	E0M	
		27 RPT2	WIM	CHR	
		28	LDA	CHR	
		29	ETR	077	
		30	BETW		
		31	BRU	DSC	
		32	LDB	077	
		33	SKM	=052	
		34	BRU	RPT5	
		35 RPT4	DSC	CH	
		36	BRR	RDPT	
		37 DSC	DSC	CH	
		38 077	HLT	077	AND HALT

00000	00000000
00001	00000000
00002	
00002	0 00 0 00000
00003	0 71 0 00072
00004	0 75 0 00073
00005	2 36 0 00000
00006	0 41 0 00005
00007	0 71 0 00001
00010	0 41 0 00010
00011	0 76 0 00061
00012	0 35 0 00066
00013	0 76 0 00060
00014	0 43 0 00000
00015	0 23 0 00000
00016	0 32 0 00000
00017	0 76 0 00016
00020	0 14 0 00031
00021	0 40 20010
00022	0 01 0 00030
00023	0 75 0 00031
00024	0 70 0 00074
00025	0 01 0 00032
00026	0 02 00000
00027	0 51 0 00002
00030	0 02 00000
00031	0 00 0 00077

3-3

```

00032 0 70 0 00075
00033 0 01 0 00035
00034 0 17 0 00076
00035 0 70 0 00076
00036 0 01 0 00046
00037 0 76 1 00066
00040 0 73 0 00077
00041 0 01 0 00016
00042 0 61 0 00066
00043 0 55 0 00060
* 00044 0 43 0 00014
* 00045 0 01 0 00016
00046 0 76 0 00000
00047 0 75 0 00100
00050 0 70 0 00057
00051 0 01 0 00053
00052 0 01 0 00016
* 00053 0 76 0 00017
* 3-4 00054 0 14 0 00031
* 00055 0 43 0 00000
* 00056 0 01 0 00016
* 00057 0 00 0 00000
* 00060 0 00 0 00000
00061 0 00 0 00062
00062 003 00001
00063 003 00003
00064 003 00010
00065 00000000
00066 00000000
00067 0 00 0 00000
00070 0 00 0 00000
00071 0 51 0 00067

00072 00177754
00073 60606060
00074 00000052
00075 00000012
00076 00000072
00077 00000000

```

```

39 RPT5 SKM =012
40 BRU $+2
41 EOR =072
42 SKM =072
43 BRU RPT8
44 LDA *TEMP+1
45 SKG =0
46 BRU RPT2
47 MIN TEMP+1
48 ADD LCBUF
49 BRM EDS
50 BRU RPT2
51 RPT8 LDA EDW
52 LDB =077777
53 SKM DLY1P
54 BRU $+2
55 BRU RPT2
56 LDA CHR
57 ETR 077
58 BRM EDC
59 BRU RPT2
60 DLY1P HLT DLY1
61 LCBUF PZE CBUF
62 EDWL HLT EDWP
63 EDWP EDF 3.1
64 EDF 3.3
65 EDF 3.8
66 TEMP DATA 0.0

67 $ENDSI PZE 0
68 HLT
69 BRR ENDSI
70 END

```

STA CHR

CONVERT 012 TO 060

00100 00077777
00005
00044
00053
00046
00055
00057
00060

CBFE
EDS
CHR
EDW
EDC
DLY1
CBUF

**SDS PROGRAM LIBRARY
PROGRAM DESCRIPTION**

Page 1 of 1

Catalog No. 030009

IDENTIFICATION: 900 Series SYMBOL Card Reader Symbolic Input Subroutine - CSI

AUTHOR: SDS

ACCEPTED: January 7, 1965

COMPUTER CONFIGURATION: Any SDS 900 series computer with card reader

PURPOSE: To read one BCD symbolic input record from the card reader.

PROGRAMMED OPERATORS: None

STORAGE: 020 locations including constants

TIMING: N/A

USE: The subroutine is selectively loaded by the SYMBOL Loader under operator control.

The subroutine has two entry points:

INPUT	Read one BCD symbolic input record into the area beginning at CBFE.
ENDSI	End of symbolic input action subroutine. For card input, this is effectively a NOP.

Buffer and unit dependence is an easily modified assembly parameter.

RECOVERY: The subroutine will halt upon either a feed error or a validity check error. In the former case, the offending card is in the hopper; in the latter it is in the stacker. Clearing the halt will cause the misread to be ignored and another card to be read.

ΔMETASYM SI, EI, L0, E0, B0.

00000
 C0000000
 C0000000
 C0000002
 C0000000
 C0000001

00000
 00000 C 00 0 00000
 00001 C 40 12006
 00002 C 01 0 00001
 00003 C 02 0 02606
 00004 C 71 0 00017
 * 00005 2 32 0 00000
 00006 C 40 21000
 00007 C 41 0 00005
 00010 C 40 20010
 00011 C 01 0 00013
 00012 C 51 0 00000
 00013 C 00 0 00000
 00014 C 01 0 00001

00015 C 00 0 00000
 00016 C 51 0 00015

00017 C0177754
 00005

3-7

1 * ΔC
 2 \$CSI RES 0
 3 S9300 EQU 0
 4 X0 EQU S9300
 5 X2 EQU 2-S9300
 6 CH EQU 0
 7 U EQU 1
 8 \$INPUT RES 0
 9 CARD PZE 0
 10 CKSK CRT CH,U
 11 BRU CKSK
 12 RCD CH,U,4
 13 LDX =00200000-20,X0
 14 CWIM WIM CBFE,X2 ((CBFE,2):=(W))
 15 BRTW
 16 BRX CWIM,X0
 17 BETW
 18 BRU CSKSE
 19 BRR CARD EXIT**
 20 CSKSE HLT HALT ON MIS-READ
 21 BRU CKSK
 22 *
 23 *
 24 \$ENDSI PZE 0
 25 BRR ENDSI
 26 END
 CBFE

**SDS PROGRAM LIBRARY
PROGRAM DESCRIPTION**

Page 1 of 2

Catalog No. 040007

IDENTIFICATION: 900 Series SYMBOL Magnetic Tape Symbolic Input Subroutine - MSI

AUTHOR: SDS

ACCEPTED: January 7, 1965

COMPUTER CONFIGURATION: Any SDS 900 series computer with Magnetic Tape Unit.

PURPOSE: To read one BCD symbolic input record from magnetic tape unit 1.

PROGRAMMED OPERATORS: None

STORAGE: 061 locations including constants

TIMING: N/A

USE: The subroutine is selectively loaded by the SYMBOL Loader under operator control.

The subroutine has two entry points:

INPUT Read one BCD symbolic input record into the area beginning at CBFE.

ENDSI End of symbolic input action subroutine. The magnetic tape unit is backspaced by the number of input records.

Buffer and unit dependence is an easily modified assembly parameter.

RECOVERY: Input records are required to be card images (20 words). A premature termination is treated as equivalent to an end-of-file. One end-of-file mark is allowed to separate input files on a tape reel, and is ignored by the assembler

RECOVERY:
(Cont)

at the beginning of the first pass. An additional end-of-file or one occurring after the first symbolic line but before the END line will cause a halt in relative location 050. Clearing the halt will cause a branch to location 1 which reinitiates the assembly process.

In the case of tape read errors, ten recovery attempts are made after which a halt will occur in relative location 021. Clearing the halt will cause the record to be accepted.

```

00000      1 *      AM
           2 $MSI   RES      0
           3 *      MAGNETIC TAPE SOURCE INPUT ROUTINE
           4 S9300  EQU      0
           5 X0    EQU     S9300
           6 X2    EQU     2-S9300
           7 CH    EQU      0
           8 U     EQU      1
           9 MM0   OPD     06000000
00000     10 $INPUT RES      0
00000  0 00 0 00000  11 RDTP  PZE      0
00001  0 71 0 00060  12      LDX     =00200000-10,X0
00002  0 46 30003  13      CLR
00003  0 35 0 00021  14      STA     E0FCNT
00004  0 37 0 00026  15 RREAD STX     RFCT,X0
00005  0 43 0 00053  16      BRM     DELAY
00006  0 02 0 02611  17 E0M  RTD     CH,U,4
00007  0 71 0 00061  18      LDX     =00200000-20,X0
* 00010  2 32 0 00000  19 RDTP1 WIM     CBFE,X2
00011  0 40 21000  20      BRTW
00012  0 40 20010  21      BETW
00013  0 01 0 00042  22      BRU     RE0F
00014  0 41 0 00010  23      BRX     RDTP1,X0
00015  24 REXIT  RES      0
* 00015  0 61 0 00000  25      MIN     LN
00016  0 51 0 00000  26      BRR     RDTP
           27 *
00017  0 71 0 00026  28 RTERR LDX     RFCT,X0
00020  0 41 0 00023  29      BRX     $+3,X0
00021  0 00 0 00000  30 E0FCNT HLT     0
00022  0 01 0 00015  31      BRU     REXIT
00023  0 43 0 00053  32      BRM     DELAY
00024  0 02 0 06631  33      SRD     CH,U,4
00025  0 01 0 00004  34      BRU     RREAD
00026  00000012  35 RFCT  DATA  012
00027  36 TEMP  RES      1
00030  0 00 0 00000  37 $ENDSI PZE     0
00031  0 43 0 00053  38      BRM     DELAY

```

* 3-10

*

00032	0 01 0 00035	39	BRU	\$+3
00033	0 02 0 06631	40	ALPH SRD	CH,U,4
00034	0 32 0 00000	41	WIM	0
00035	0 60 0 00015	42	MM0	LN
00036	0 20 0 00000	43	N0P	
00037	0 53 0 00035	44	SKN	LN
00040	0 01 0 00033	45	BRU	ALPH
00041	0 51 0 00030	46	BRR	ENDSI
00042	0 40 20010	47	RE0F BETW	
00043	0 01 0 00017	48	BRU	RTERR
00044	0 76 0 00021	49	LDA	E0FCNT
00045	0 55 0 00037	50	ADD	LN
00046	0 61 0 00021	51	MIN	E0FCNT
00047	0 73 0 00051	52	SKG	HLT
00050	0 01 0 00005	53	BRU	RREAD+1
00051	0 00 0 00000	54	HLT HLT	0
00052	0 01 0 00001	55	BRU	1
00053	0 00 0 00000	56	DELAY PZE	0
00054	0 40 10411	57	TRT	CH,U
00055	0 40 21000	58	BRTW	
00056	0 01 0 00054	59	BRU	\$-2
00057	0 51 0 00053	60	BRR	DELAY
		61	END	
00060	00177766			
00061	00177754			
00010			CBFE	
00045			LN	

3-11

**SDS PROGRAM LIBRARY
PROGRAM DESCRIPTION**

Page 1 of 1

Catalog No. 020025

IDENTIFICATION: 900 Series SYMBOL Paper Tape Punch Binary Output
Subroutine - PBO

AUTHOR: SDS

ACCEPTED: January 5, 1965

COMPUTER
CONFIGURATION: Any SDS 900 series computer with Paper Tape Punch

PURPOSE: To output on the paper tape punch one binary output
record.

PROGRAMMED
OPERATORS: None

STORAGE: 027 locations including constants

TIMING: N/A

USE: The subroutine is selectively loaded by the SYMBOL
Loader under operator control.

The subroutine has two entry points:

WRITR Punch the record whose origin is CW and
 whose length is specified in DWC

WEOF Feed blank tape (approximately 48 frames)

Buffer and unit dependence is an easily modified assembly
parameter.

AMETASYM SI, EI, LO, EO, BO.

00000 C0000000
C0000000
C0000002
C0000000
C0000001

00000 C 00 0 00000
00001 C 76 0 00015
* 00002 C 35 0 00000
* 00003 C 02 0 00644
* 00004 C 12 1 00002
* 00005 C 60 0 00000
* 00006 C 61 0 00004
* 3-13 00007 C 53 0 00005
00010 C 01 0 00004
00011 C 02 14000
00012 C 40 21000
00013 C 01 0 00012
00014 C 51 0 00000
* 00015 C 00 0 00000
00016 C 00 0 00000
00017 C 71 0 00026
00020 C 02 0 00644
00021 C 02 14000
00022 C 40 21000
00023 C 01 0 00022
00024 C 41 0 00020
00025 C 51 0 00016

00026 C0177774
00006
00007
00015

1 * ΔXP
2 \$PB0 RES 0
3 S9300 EQU 0
4 X0 EQU S9300
5 X2 EQU 2-S9300
6 CH EQU 0
7 U EQU 1
8 MM0 0PD 06000000
9 * PAPER TAPE PUNCH OUTPUT SUBROUTINE
10 \$WRITR PZE 0
11 LDA LCW
12 STA ICW INITIALIZE 'MIW' ADDRESS
13 WE0M PTL CH,U,4
14 MIW *ICW
15 MM0 DWC
16 MIN ICW
17 SKN DWC
18 BRU WE0M+1
19 T0P CH
20 BRTW
21 BRU \$-1
22 BRR WRITR EXIT
23 LCW PZE CW
24 \$WE0F PZE 0
25 LDX =00200000-4,X0
26 PZ PTL CH,U,4
27 T0P CH
28 BRTW
29 BRU \$-1
30 BRX PZ,X0
31 BRR WE0F
32 END

ICW
DWC
CW

**SDS PROGRAM LIBRARY
PROGRAM DESCRIPTION**

Page 1 of 1

Catalog No. 030008

IDENTIFICATION: 900 Series SYMBOL Card Punch Binary Output Subroutine - CBO

AUTHOR: SDS

ACCEPTED: January 5, 1965

COMPUTER CONFIGURATION: Any SDS 900 series computer with Card Punch (Buffered or Unbuffered) and Binary Coupler

PURPOSE: To output on the card punch one binary output record.

PROGRAMMED OPERATORS: None

STORAGE: 052 locations including constants

TIMING: N/A

USE: The subroutine is selectively loaded by the SYMBOL Loader under operator control.

The subroutine has two entry points:

WRITR Punch the record whose origin is CW and whose length is specified in DWC.

WEOF Feed two blank cards.

Buffer and unit dependence is an easily modified assembly parameter.

METASYM SI, EI, LO, EO, BO.

00000		1 *	ΔXC		
		2 \$CB0	RES	0	
	C0000000	3 S9300	EQU	0	
	C0000000	4 X0	EQU	S9300	
	C0000002	5 X2	EQU	2-S9300	
	C0000000	6 CH	EQU	U	
	C0000001	7 U	EQU	1	
00000	C 00 0 00000	8 \$WRITR	PZE	0	ENTRY
00001	C 76 0 00044	9	LDA	=-12	LOAD REPEAT COUNT
00002	C 40 14046	10	CPT	CH,U	
00003	C 01 0 00002	11	BRU	\$-1	
00004	C 40 12046	12	PBT	CH,U	
00005	C 46 30003	13	CLR		BUFFERED, SET REPEAT COUNT TO 0
00006	C 35 0 00032	14	STA	PETEC	SAVE REPEAT COUNT
00007	C 40 21000	15 PETEL1	BRTW		WAIT FOR BUFFER TO BE READY
00010	C 01 0 00007	16	BRU	\$-1	
00011	C 02 0 03646	17	PCB	CH,U,4	
00012	C 76 0 00035	18	LDA	PETECW	
00013	C 35 0 00033	19	STA	PETEA	INITIALIZE BUFFER ADDRESS
00014	C 71 0 00045	20	LDX	=00200000-40,X0	
00015	C 75 0 00034	21	LDB	PETEO	
00016	C 76 0 00000	22	LDA	DWC	A = RECORD SIZE - 1
00017	C 72 0 00046	23 PETEL2	SKA	=040000000	IS A NEGATIVE
00020	C 36 0 00033	24	STB	PETEA	YES, SET ADDRESS = ADDRESS OF 0
00021	C 12 1 00033	25	MIW	*PETEA	OUTPUT WORD
00022	C 61 0 00033	26	MIN	PETEA	INCREMENT ADDRESS
00023	C 54 0 00047	27	SUB	=1	DECREMENT COUNT
00024	C 41 0 00017	28	BRX	PETEL2,X0	
00025	C 02 14000	29	T0P	CH	
00026	C 61 0 00032	30	MIN	PETEC	INCREMENT REPEAT COUNT
00027	C 53 0 00032	31	SKN	PETEC	IS ALL TRANSMISSION COMPLETE
00030	C 51 0 00000	32	BRR	WRITR	YES, EXIT
00031	C 01 0 00007	33	BRU	PETEL1	NO, LOOP AGAIN
		34 *			
00032		35 PETEC	RES	1	SAVE LOCATION FOR REPEAT COUNT
00033		36 PETEA	RES	1	SAVE LOCATION FOR ADDRESS
00034	C 00 0 00050	37 PETEO	PZE	=0	ADDRESS OF A ZERO CONSTANT

* 00035 C 00 0 00000
00036 C 00 0 00000
00037 C 76 0 00051
* 00040 C 35 0 00016
00041 C 43 0 00000
00042 C 43 0 00000
00043 C 51 0 00036

38 PETECW PZE CW
39 \$WE0F PZE 0
40 LDA ==-1
41 STA DWC
42 BRM WRITR
43 BRM WRITR
44 BRR WE0F
45 END

00044 77777764
00045 C0177730
00046 40000000
00047 C0000001
00050 C0000000
00051 77777777
00040
00035

DWC
CW

**SDS PROGRAM LIBRARY
PROGRAM DESCRIPTION**

Page 1 of 1

Catalog No. 020023

IDENTIFICATION: 900 Series SYMBOL Typewriter Listing Subroutine - TLO

AUTHOR: SDS

ACCEPTED: January 5, 1965

COMPUTER
CONFIGURATION: Any SDS 900 series computer with typewriter

PURPOSE: To output on the typewriter one line of the SYMBOL
output listing

PROGRAMMED
OPERATORS: None

STORAGE: 0154 locations including constants

TIMING: N/A

USE: The subroutine is selectively loaded by the SYMBOL
Loader under operator control.

The subroutine has two entry points:

PRNT Type the line whose origin is LBUF and
 whose length is specified in EDCT. If the
 line exceeds 80 characters, the subroutine
 types the remainder on the succeeding line,
 preceded by a carriage return and tab.

HOME Skip to top of page. This subroutine is
 entered by PRNT when the line count exceeds
 50 and by the assembler upon encountering a
 PAGE directive.

Buffer and unit dependence is an easily modified assembly
parameter.

ΔMETASYM SI, EI, Lθ, Eθ, Bθ.

00000
 C0000000
 C0000000
 C0000002
 C0000000
 C0000001

00000 C 00 0 00000
 00001 C 76 0 00136
 00002 C 75 0 00137
 * 00003 C 60 0 00000
 * 00004 C 71 0 00003
 * 00005 C 53 0 00004
 * 00006 2 70 0 00000
 3-18 00007 C 01 0 00011
 00010 C 01 0 00003
 00011 C 43 0 00107
 00012 C 76 0 00137
 * 00013 C 54 0 00005
 * 00014 C 35 0 00013
 00015 C 73 0 00140
 00016 C 76 0 00140
 00017 C 35 0 00133
 00020 C 76 0 00134
 00021 C 43 0 00050
 * 00022 C 76 0 00014
 * 00023 C 35 0 00133
 00024 C 53 0 00022
 00025 C 01 0 00035

00026 C 61 0 00131
 00027 C 76 0 00141
 00030 C 43 0 00077
 00031 C 76 0 00142
 00032 C 43 0 00077
 00033 C 76 0 00135

1 * ΔXXT
 2 \$ILO RES 0
 3 S9300 EQU 0
 4 X0 EQU S9300
 5 X2 EQU 2-S9300
 6 CH EQU 0
 7 U EQU 1
 8 MMθ θPD 06000000
 9 \$PRNT PZE 0
 10 LDA =060606060
 11 LDB =-1
 12 TYP MMθ EDCT
 13 LDX EDCT,X0
 14 SKN EDCT
 15 SKM LBUF,X2
 16 BRU TYPL1
 17 BRU TYP
 18 TYPL1 BRM LNCT
 19 LDA =-1
 20 SUB EDCT
 21 STA EDCT
 22 SKG =-20
 23 LDA =-20
 24 STA TTMP
 25 LDA LLBUF
 26 BRM TYPE
 27 LDA EDCT
 28 STA TTMP
 29 SKN EDCT
 30 BRU PRN2
 31 * TYPE LAST N-75 CHARACTERS ON NEXT LINE
 32 TYP2 MIN CTR INCREMENT LINE COUNTER
 33 LDA =052000000
 34 BRM TYCC TYPE CARRIAGE RETURN
 35 LDA =072000000
 36 BRM TYCC TYPE TAB
 37 LDA LTBF

INCREMENT AND TEST LINE COUNT

```

00034 C 43 0 00050
00035 C 71 0 00143
00036 C 76 0 00136
* 00037 2 35 0 00000
* 00040 C 41 0 00037
* 00041 C 77 0 00006
* 00042 C 37 0 00000
00043 C 76 0 00144
* 00044 C 35 0 00024
00045 C 76 0 00141
00046 C 43 0 00077
00047 C 51 0 00000

```

```

00050 C 00 0 00000
* 00051 C 35 0 00042
* 00052 C 76 1 00051
3-19 00053 C 75 0 00145
00054 C 54 0 00146
00055 C 72 0 00145
00056 C 55 0 00147
00057 C 55 0 00150
00060 C 6620 006
00061 C 72 0 00151
00062 C 01 0 00054
00063 C 36 0 00132
00064 C 02 0 02641
00065 C 12 0 00132
00066 C 02 14000
00067 C 40 21000
* 00070 C 01 0 00067
* 00071 C 61 0 00052
00072 C 61 0 00044
00073 C 61 0 00133
00074 C 53 0 00133
00075 C 51 0 00050
00076 C 01 0 00052
00077 C 00 0 00000

```

```

38 BRM TYPE
39 PRN2 LDX =00200000-8,X0
40 LDA = ' '
41 STA CBUF,X2
42 BRX $-1,X0
43 EAX LBUF,X0
44 STX EDW,X0
45 LDA =8
46 STA EDCT
47 LDA =052000000
48 BRM TYCC
49 BRR PRNT
50 *
51 * TYPE N CHARACTERS
52 TYPE PZE
53 STA EDW
54 TMIW LDA *EDW
55 LDB =077
56 TMIW1 SUB =060
57 SKA =077
58 ADD =046
59 ADD =012
60 RCY 6
61 SKA =077777700
62 BRU TMIW1
63 STB IMP
64 TYP CH,U,4
65 MIW IMP
66 TBP CH
67 TBRT BRTW
68 BRU TBRT
69 MIN EDW
70 MIN EDCT
71 MIN ITMP
72 SKN TTMP
73 BRR TYPE
74 BRU TMIW
75 * TYPE CONTROL CHARACTER
76 TYCC PZE

```

TYPE LAST N-75 CHARS OF LINE

ENTRY
ADDRESS OF 1ST CHAR TO TYPE

STORE DATUM

ENTRY

00100 C 35 0 00132
 00101 C 02 0 02041
 00102 C 12 0 00132
 00103 C 02 14000
 00104 C 40 21000
 00105 C 01 0 00104
 00106 C 51 0 00077

00107 C 00 0 00000
 00110 C 61 0 00131
 00111 C 76 0 00131
 00112 C 73 0 00152
 00113 C 51 0 00107
 00114 C 43 0 00116
 00115 C 51 0 00107
 00116
 00116 C 00 0 00000
 00117 C 76 0 00131
 00120 C 55 0 00153
 00121 C 35 0 00131
 00122 C 71 0 00131
 00123 C 76 0 00141
 00124 C 43 0 00077
 00125 C 41 0 00123
 00126 C 46 30003
 00127 C 35 0 00131
 00130 C 51 0 00116

00131 C0000000
 00132 C 00 0 00000
 00133 C 00 0 00000
 00134 C 00 0 00041
 00135 C 00 0 00000

00136 60606060
 00137 77777777
 00140 77777754
 00141 52000000

77 STA TMP
 78 TYC1 IYP CH,U.1 ✓
 79 MIW TMP
 80 TOP CH
 81 TYSS BRTW
 82 BRU TYSS
 83 BRK TYCC EXIT

84 *
 85 * LINE COUNT AND PAGE EJECT SUBROUTINE

86 LNCT PZE
 87 MIN CTR
 88 LDA CTR
 89 SKG =50
 90 BRR LNCT
 91 BRM THOME HOME PAGE
 92 BRR LNCT EXIT
 93 \$HOME RES 0
 94 THOME PZE 0
 95 LDA CTR LINES TYPED
 96 ADD =00200000-66
 97 STA CTR
 98 LDX CTR,X0
 99 NPG LDA =052000000
 100 BRM TYCC
 101 BRX NPG,X0
 102 CLR
 103 STA CTR
 104 BRR THOME

105 *
 106 CTR DATA 0
 107 TMP PZE
 108 TIMP PZE
 109 LLBUF PZE LBUF
 110 LTBF E PZE TIBFE
 111 END

3-20

*
*

00142 72000000
00143 C0177770
00144 C0000010
00145 C0000077
00146 C0000060
00147 C0000046
00150 C0000012
00151 77777700
00152 C0000062
00153 C0177676
00072
00134
00037
00071
00135

EDCT
LBUF
CBUF
EDW
TBFE

**SDS PROGRAM LIBRARY
PROGRAM DESCRIPTION**

Page 1 of 1

Catalog No. 062002

IDENTIFICATION: 900 Series SYMBOL Line Printer Listing Subroutine - LLO

AUTHOR: SDS

ACCEPTED: January 4, 1965

COMPUTER
CONFIGURATION: Any SDS 900 series computer with Buffered Line Printer

PURPOSE: To output on the printer one line of the SYMBOL output listing.

PROGRAMMED
OPERATORS: None

STORAGE: 061 locations including constants

TIMING: N/A

USE: The subroutine is selectively loaded by the SYMBOL Loader under operator control.

The subroutine has two entry points:

PRNT Skip to channel 0. Then print the line whose
 . origin is LBUF and whose length is specified
 in EDCT.

HOME Skip to channel 1.

In the event of a printer fault, the subroutine will halt in relative location 023.

00000		1 *	ΔXXL		
		2 \$LL0	RES	0	
	C0000000	3 S9300	EQU	0	
	C0000000	4 X0	EQU	S9300	
	C0000002	5 X2	EQU	2-S9300	
00000	C 00 0 00000	6 \$PRNT	PZE	0	
00001	C 40 0 12060	7 PRN1	SKS	012060	SKIP IF BUFFERED PRINTER READY
00002	C 01 0 00001	8	BRU	PRN1	
00003	C 02 0 10460	9	EOM	010460	STEP ONE LINE BEFORE PRINTING
00004	C 43 0 00021	10 PRST	BRM	LINEP	PRINT VARIABLE LENGTH LINE
00005	C 40 20010	11	BETW		
00006	C 01 0 00020	12	BRU	PERRP	
00007	C 71 0 00055	13 PRN2	LDX	=00200000-8,X0	
00010	C 76 0 00056	14	LDA	=060606060	
00011	2 35 0 00000	15 SBLK	STA	CBUF,X2	STORE BLANKS IN 1ST 32 POSNS
00012	C 41 0 00011	16	BRX	SBLK,X0	
00013	C 77 0 00000	17	EAX	LBUF,X0	
00014	C 37 0 00000	18	STX	EDW,X0	
00015	C 76 0 00057	19	LDA	=8	
00016	C 35 0 00000	20	STA	EDCT	
00017	C 51 0 00000	21	BRR	PRNT	*EXIT*
		22 *			
		23 *			
00020	C 00 0 00000	24 PERRP	HLT		
		25 *	REPLACE PREVIOUS LINE WITH RESTART PROCEDURE		
		26 *	PRINT ONE VARIABLE LENGTH LINE		
00021	C 00 0 00000	27 LINEP	PZE		ENTRY
00022	C 40 0 11060	28	SKS	011060	SKIP IF NO PRINTER FAULT

3-23

```

00023 C 00 0 00000      29      HLT
* 00024 C 76 0 00016      30      LDA      EDCT
00025 C 55 0 00042      31      ADD      DPTWI
00026 C 35 0 00043      32      STA      DPTW
00027 C 76 0 00060      33      LDA      =00200000
* 00030 C 54 0 00024      34      SUB      EDCT
* 00031 C 35 0 00030      35      STA      EDCT
* 00032 C 71 0 00031      36      LDX      EDCT,X0
00033 C 02 0 02660      37      EOM      02660
00034 C 12 1 00043      38      MIW      *DPTW
00035 C 41 0 00034      39      BRX      $-1,X0
00036 C 02 14000         40      TOP
00037 C 40 21000         41      BRTW
00040 C 01 0 00037      42      BRU      $-1
00041 C 51 0 00021      43      BRR      LINEP
44 *
00042 2 00 0 00013      45 DPTWI PZE      LBUF,X2
* 00043 2 00 0 00042      46 DPTW  PZE      LBUF,X2
47 *
48 *
00044 C 00 0 00000      49 $HOME PZE      0
00045 C 40 0 12060      50      SKS      012060      SKIP IF BUFFERED PRINTER READY
00046 C 01 0 00045      51      BRU      $-1
00047 C 02 0 11460      52      EOM      011460      RESTORE PAGE OR 'HOME' PAPER
00050 C 02 0 02660      53      EOM      02660      START BUFFERED PRINTER NR 1
00051 C 02 0 14000      54      EOM      014000
00052 C 40 21000         55      BRTW
00053 C 01 0 00052      56      BRU      $-1
00054 C 51 0 00044      57      BRR      HOME      EXIT
58      END

00055 C0177770
00056 60606060
00057 C0000010
00060 C0200000

00011      CBUF
00043      LBUF
00014      EDW
00032      EDCT

```

**SDS PROGRAM LIBRARY
PROGRAM DESCRIPTION**

Page 1 of 2

Catalog No. 012005

IDENTIFICATION: 900 Series SYMBOL Part I

AUTHOR: SDS

ACCEPTED: January 12, 1965

COMPUTER
CONFIGURATION: Any SDS 900 series computer with at least a 4K memory.

PURPOSE: To provide main SYMBOL control.

PROGRAMMED
OPERATORS: CAB, CBA, CAX, CXA, CBX, CNE, SKE, SKR, MUL,
DIV, ADM, XMA

STORAGE: 01462 locations including constants

TIMING: N/A

USE: SYMBOL consists of three parts (separately assembled programs) plus a mnemonic table plus I/O subroutines.

Part I is the main control portion of SYMBOL and is entered by the execution of a branch to location 1. After initialization, a halt occurs in relative location 0234. This halt, which precedes pass 1, allows input to be readied in the appropriate peripheral unit. When batched assemblies are desired (as when files are sequentially located on magnetic tape) the halt may be replaced by a NOP.

Following the second pass of the assembly, SYMBOL reinitializes in preparation for another assembly.

In addition to its executive functions, Part I performs the processing for all directives. These include EQU, OPD, FORM, PAGE, AORG, RORG, RES, DATA, DED, BCD, TEXT and END.

USE: (Cont)

Subroutines:

DLBL Define label

BRM DLBL

return

If LBL1 contains zero, these subroutines will do nothing. Otherwise the contents of LBL1 and the first two characters of LBL1+ γ are considered a label, and this label will be equated to the current value of the location counter and inserted in the symbol table. The item will be relocatable if the location counter was relocatable.

LXL Process external labels

BRM LXL with item at LBL1

return

If item at LBL1 is found in the symbol table, this table item is made external.

ILOC Increment location counter

BRM ILOC with base to be incremented
in Areturn with new location counter value in
A and LOC1

Computes maximum location counter value, then increments location counter. Uses MAXL and SCAN subroutines.

900 SERIES SYMBOL PART I

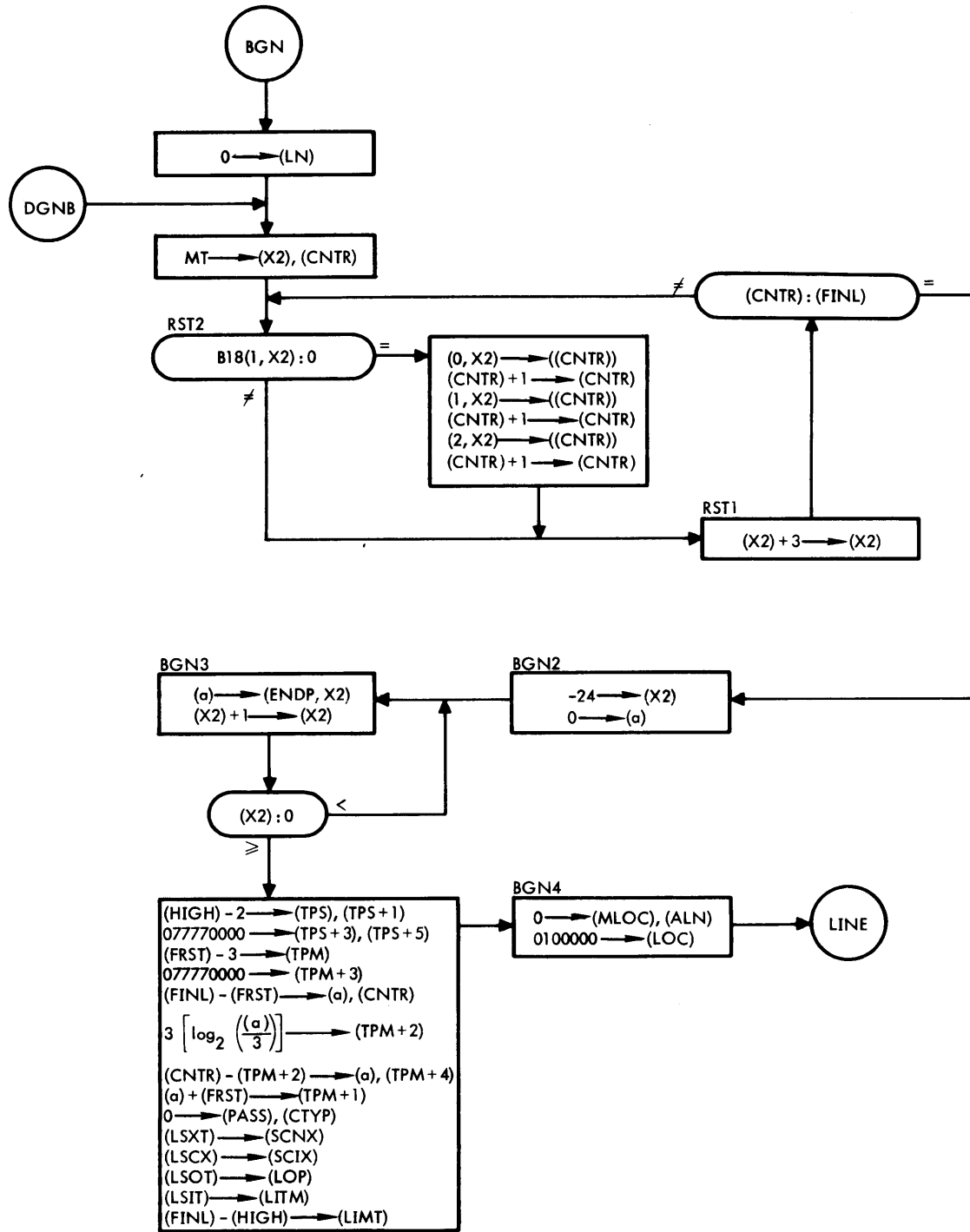

900 SERIES SYMBOL PART I (cont.)

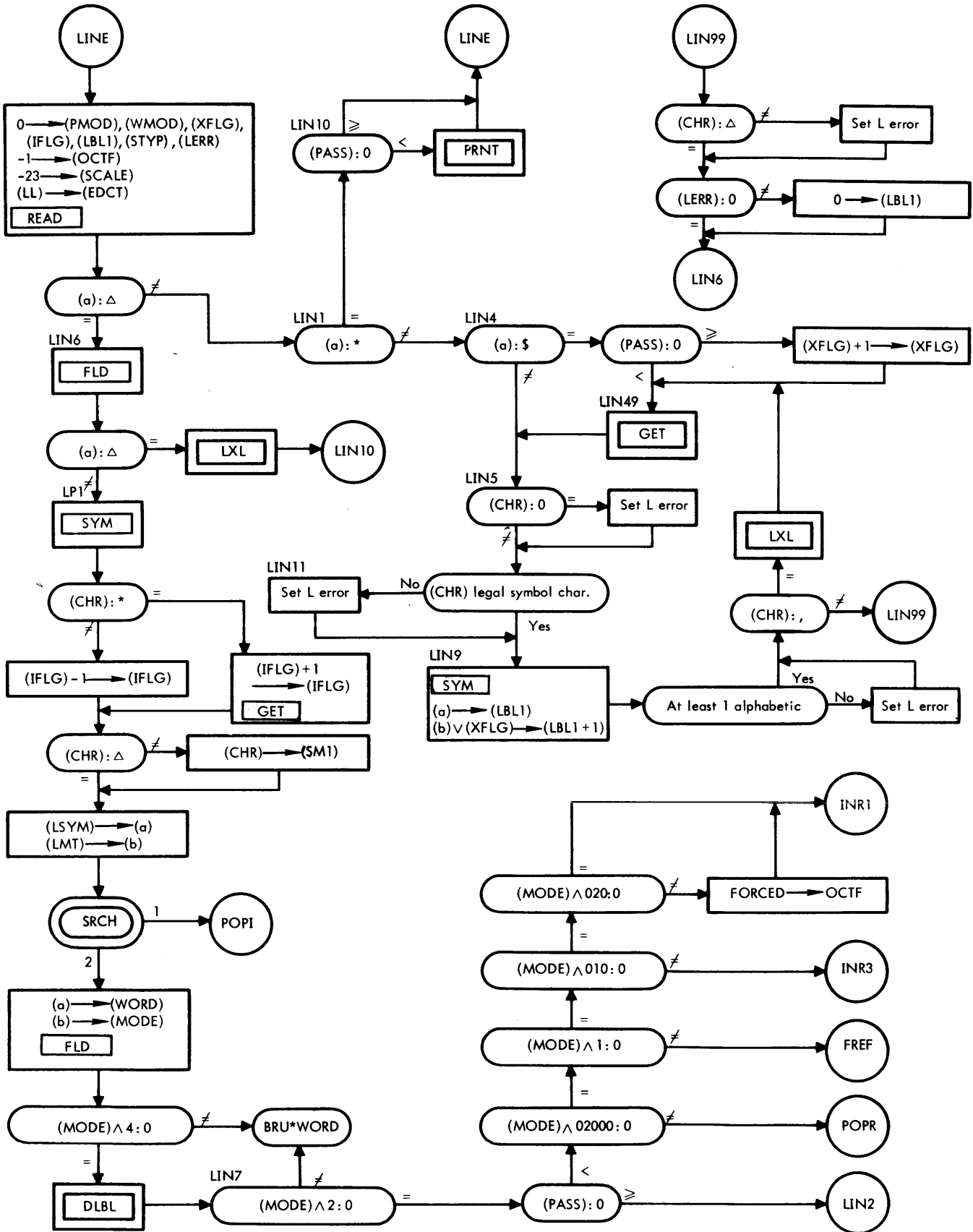

900 SERIES SYMBOL PART I (cont.)

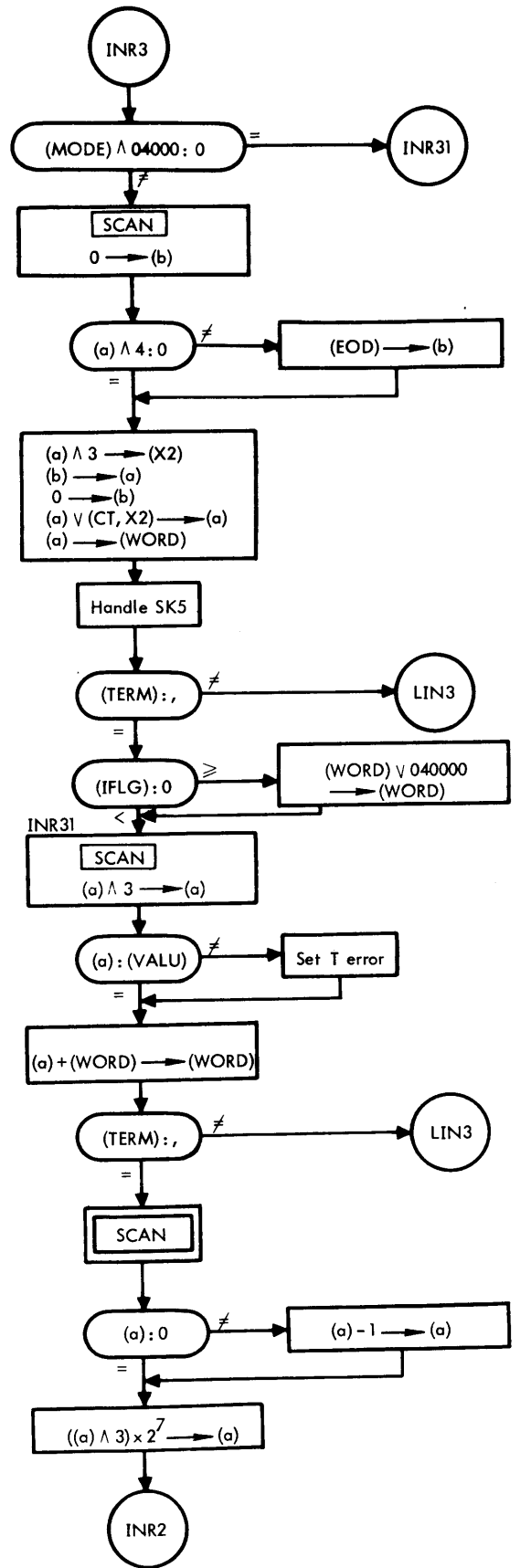
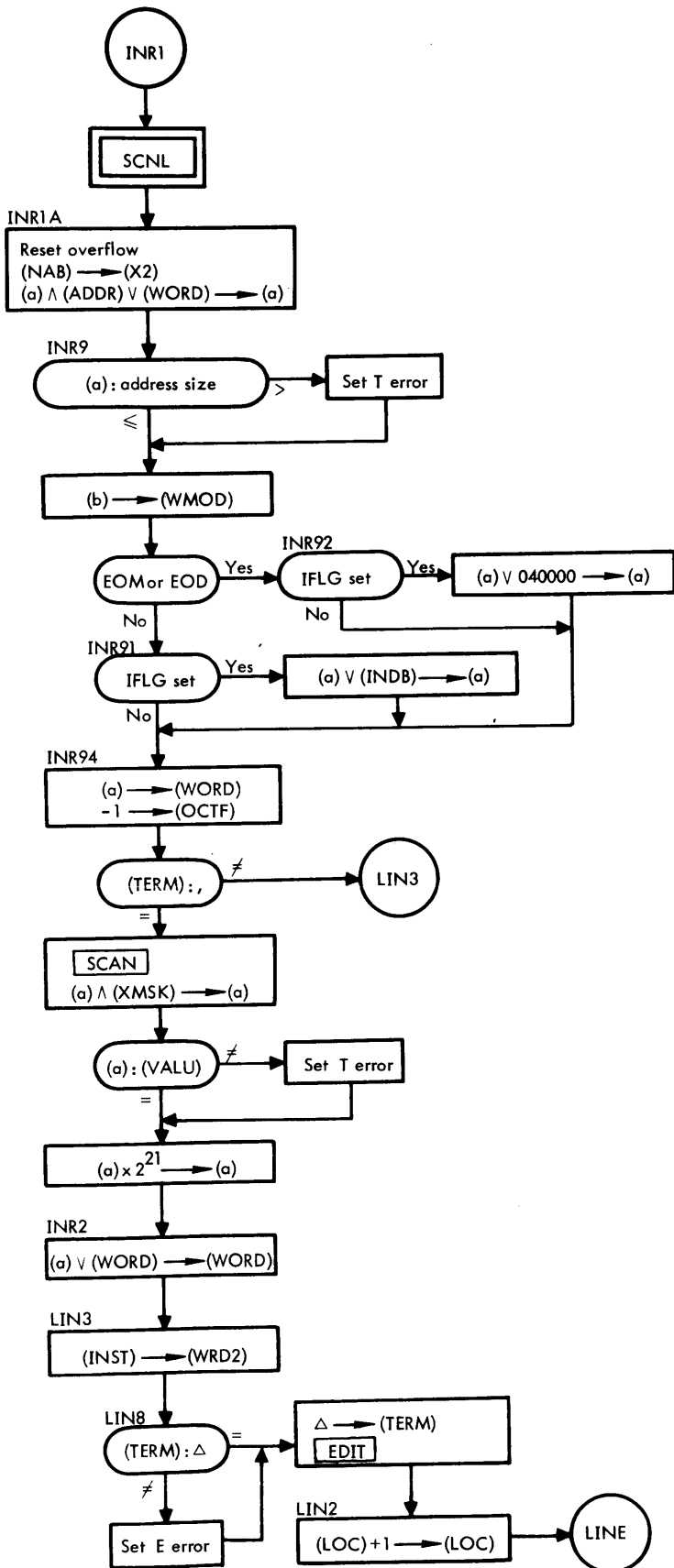

900 SERIES SYMBOL PART I (cont.)

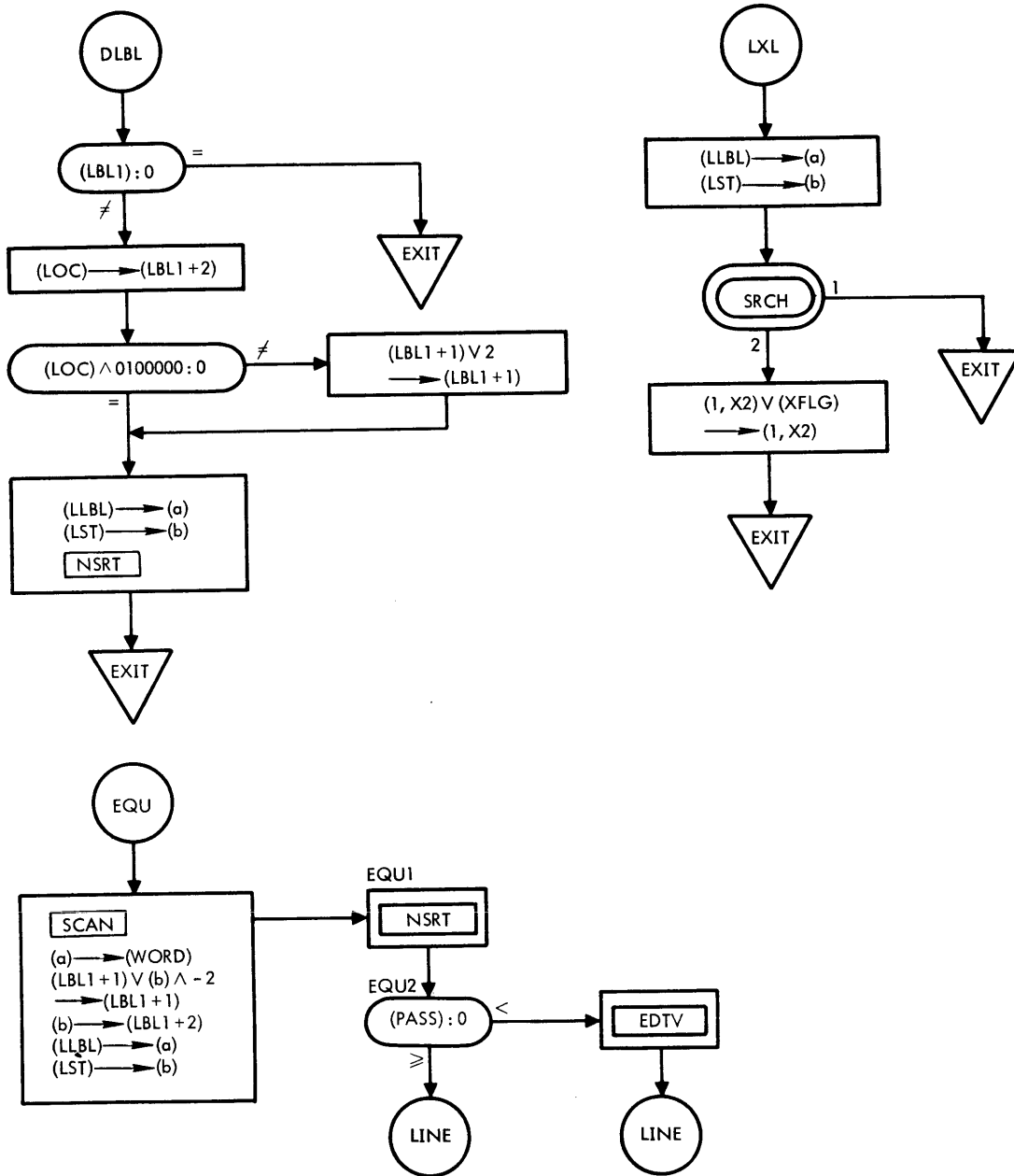

900 SERIES SYMBOL PART I (cont.)

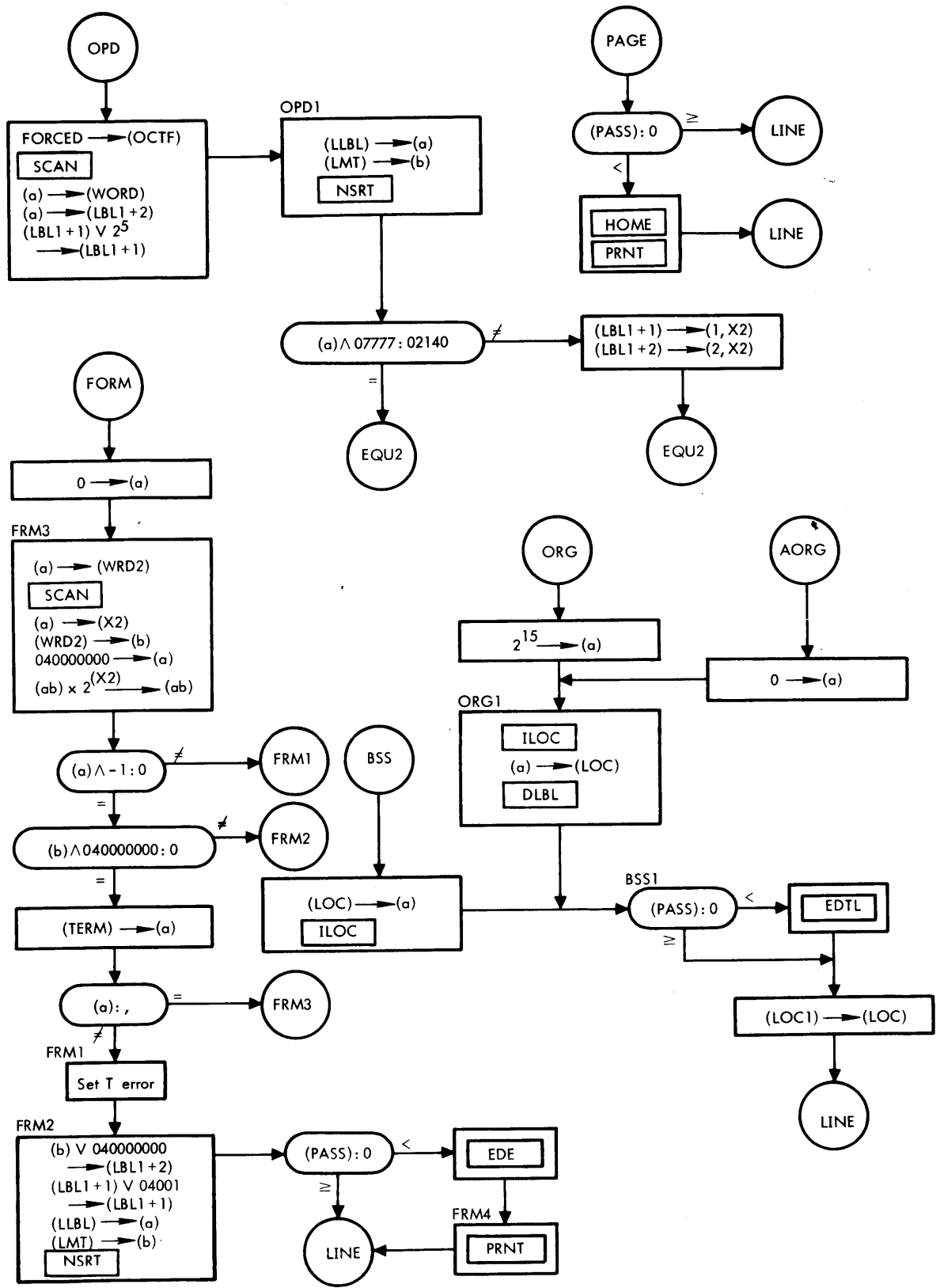

900 SERIES SYMBOL PART I (cont.)

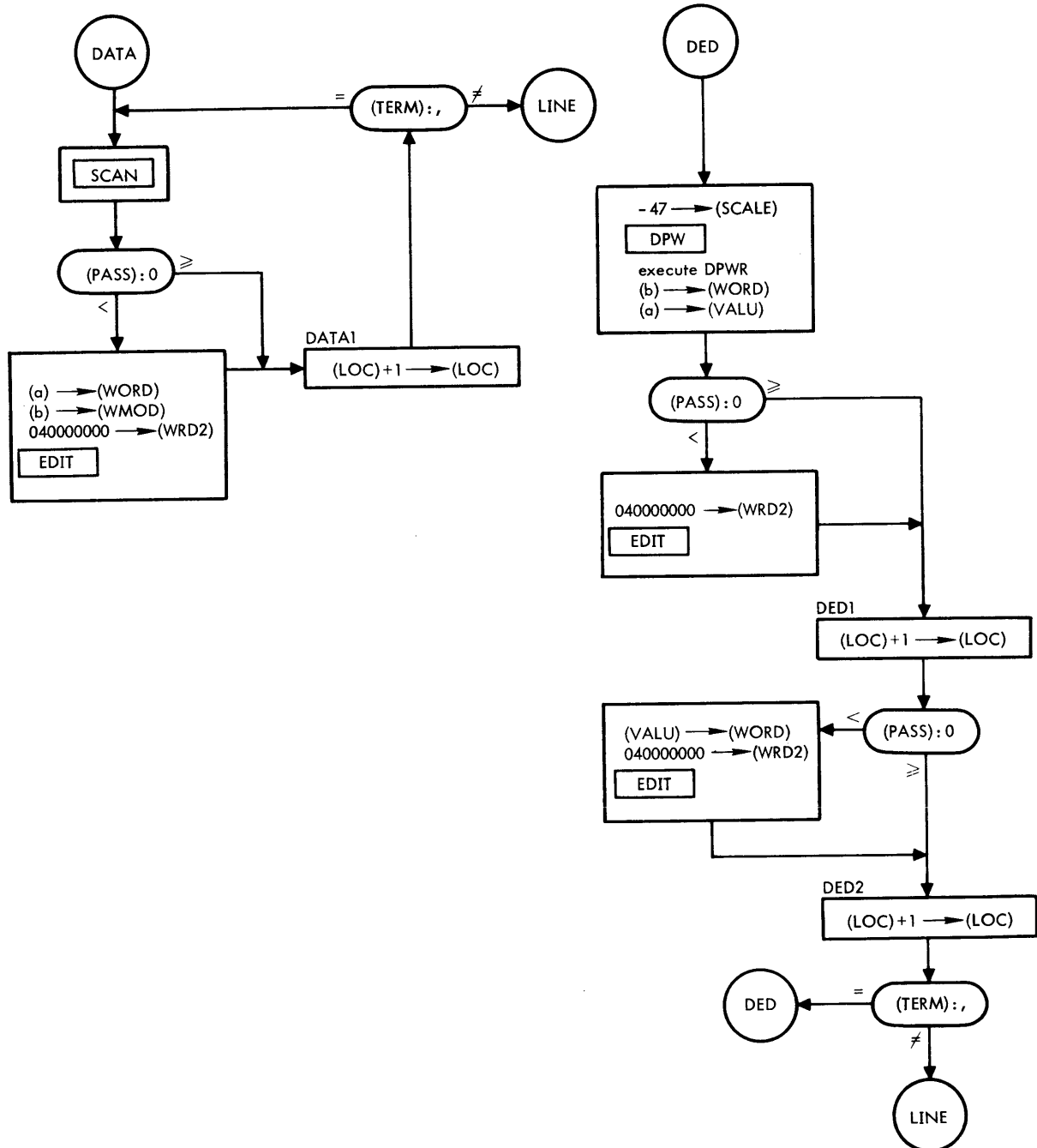

900 SERIES SYMBOL PART I (cont.)

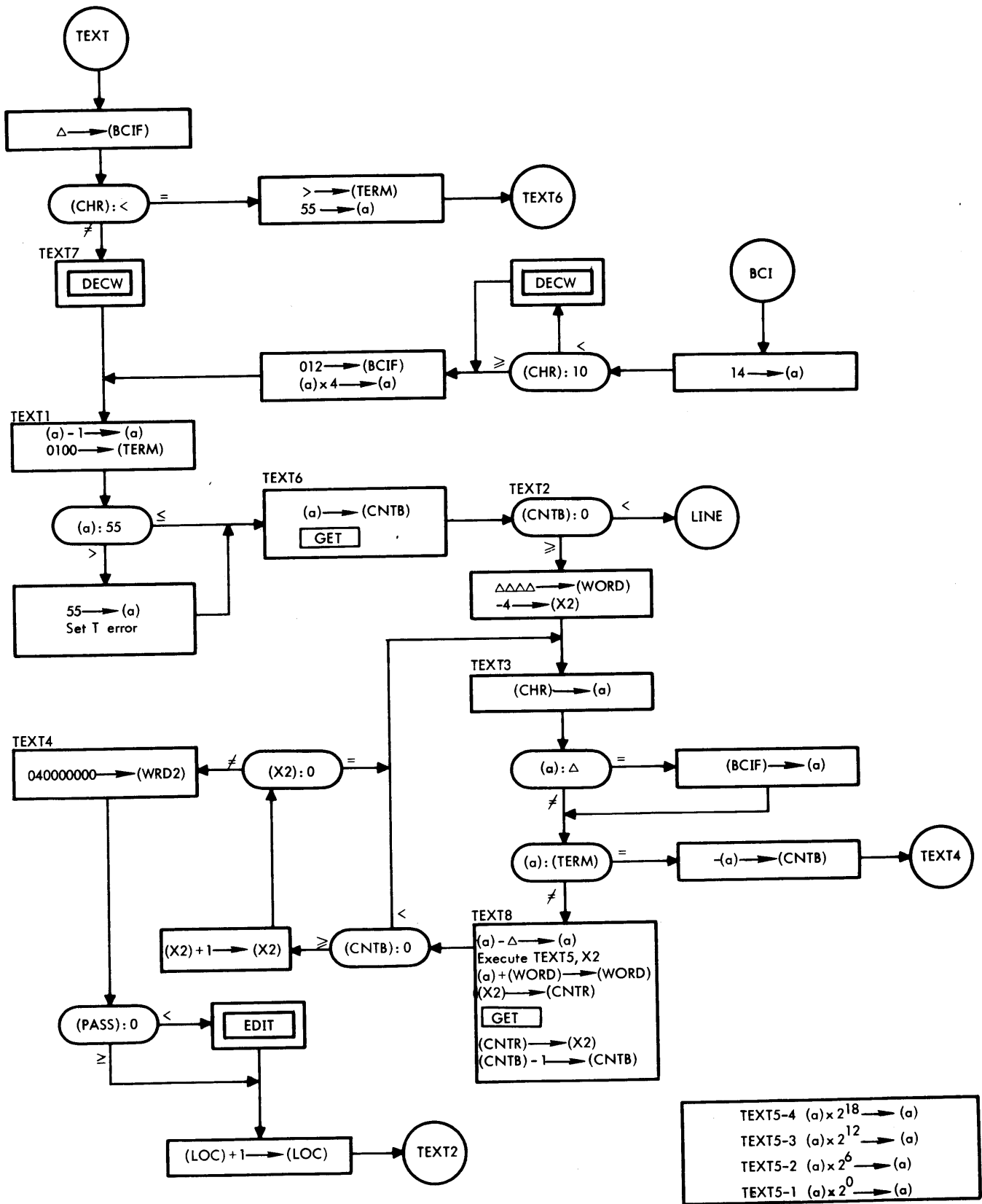

900 SERIES SYMBOL PART I (cont.)

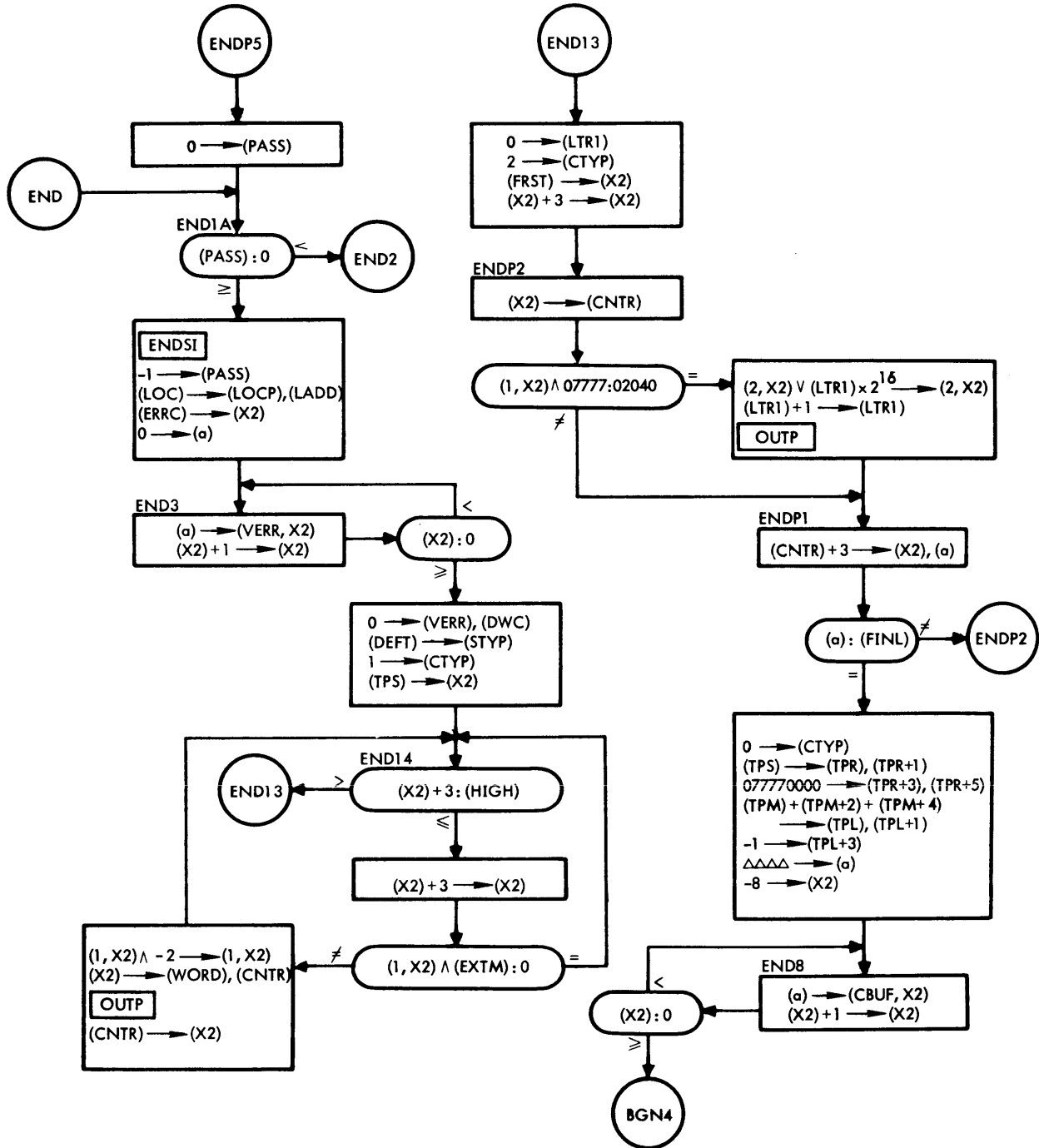

900 SERIES SYMBOL PART I (cont.)

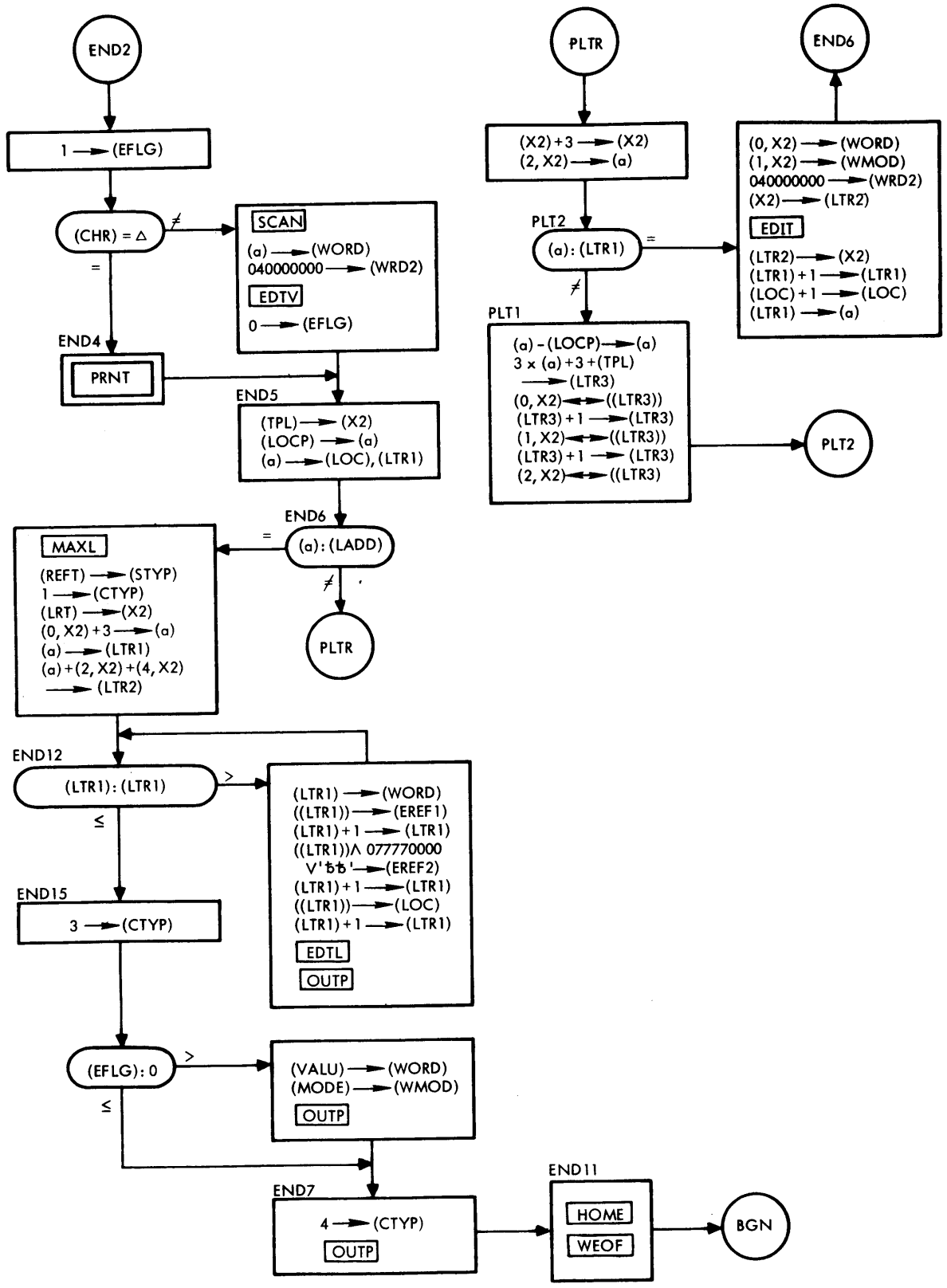

900 SERIES SYMBOL PART I (cont.)

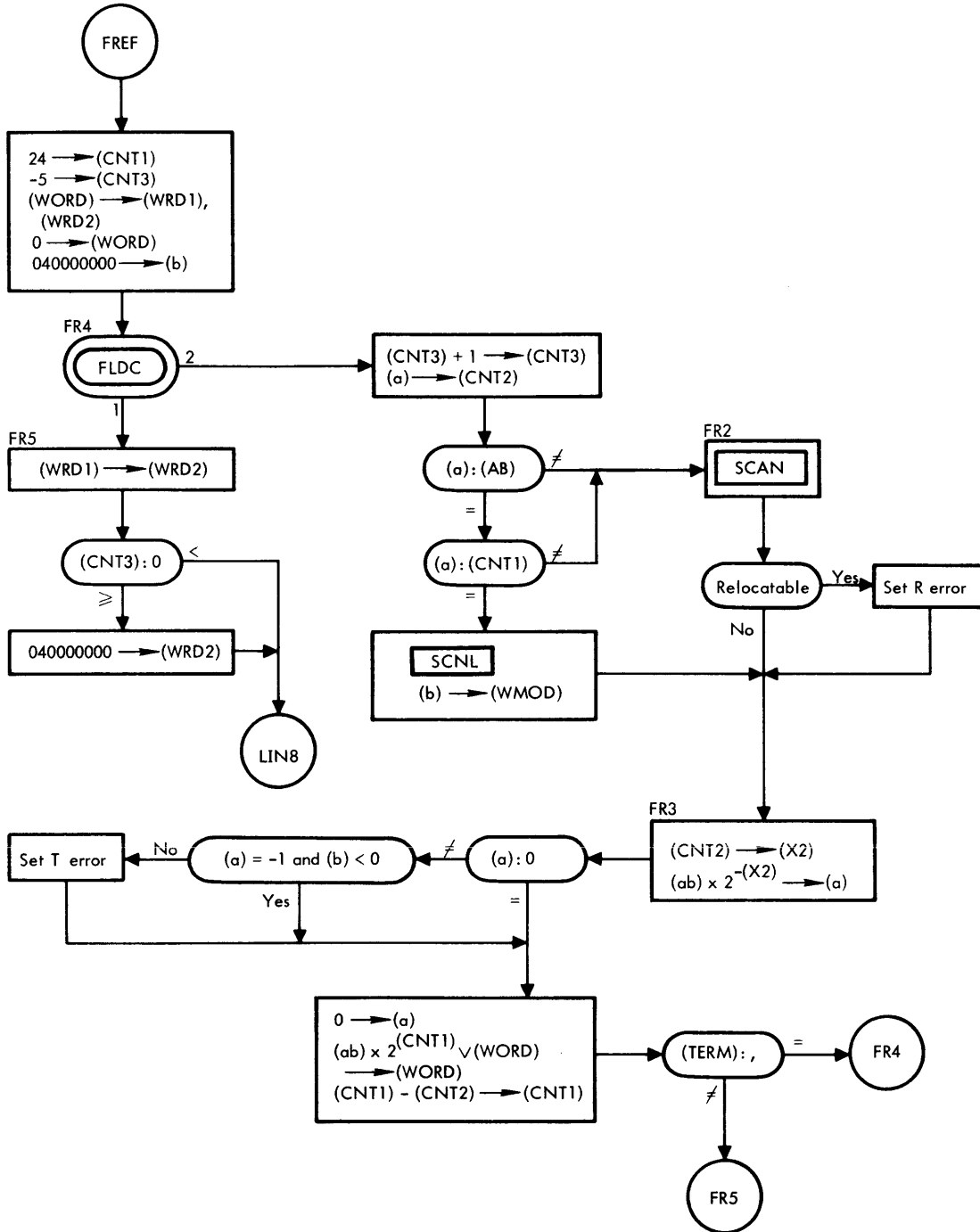

1	*	S1		
2	*			
3	CAB	OPD	016400000	
4	CBA	OPD	016500000	
5	CAX	OPD	016600000	
6	CXA	OPD	016700000	
7	CBX	OPD	017000000	
8	CNA	OPD	017100000	
9	SKE	OPD	017200000	
10	SKR	OPD	017300000	
11	MUL	OPD	017400000	
12	DIV	OPD	017500000	
13	ADM	OPD	017600000	
14	XMA	OPD	017700000	
15	S9300	EQU	0	
16	X0	EQU	S9300	
17	X2	EQU	2-S9300	
18	IN	EQU	1	
19	OUT	EQU	2	
20		AORG	1	
21		BRU	BGN	RESTART
22		AORG	34	
23	SXT	RES	4	
24	SCXT	RES	4	
25	SSOT	RES	16	
26	SIT	RES	16	
27	TPM	RES	6	
28	TPS	RES	6	
29	TPR	RES	6	
30	STPL	RES	6	
31	ENDP	RES	0	
32	SLOC	RES	1	
33	\$PMOD	RES	1	
34	\$WMOD	RES	1	
35	\$WORD	RES	1	
36	\$WRD2	RES	1	
37	\$WRD1	RES	1	
38	\$TERM	RES	1	

00000000
00000000
00000002
00000001
00000002
00001
00001 0 01 0 00127
00042
00042
00046
00052
00072
00112
00120
00126
00134
00142
00142
00143
00144
00145
00146
00147
00150

4-13

4-14

00151	39	\$CTYP	RES	1
00152	40	\$STYP	RES	1
00153	41	\$PASS	RES	1
00154	42	HIGH	RES	1
00155	43	\$LIMT	RES	1
00156	44	L0C1	RES	1
00157	45	L0CP	RES	1
00000	46		ORG	0
00000	47	\$LADD	RES	1
00001	48	\$0CTF	RES	1
00002	49	XFLG	RES	1
00003	50	\$IFLG	RES	1
00004	51	EFLG	RES	1
00005	52	\$LTR1	RES	1
00006	53	\$LTR2	RES	1
00007	54	\$LTR3	RES	1
00010	55	\$MODE	RES	1
00011	56	\$VALU	RES	1
00012	57	\$XERR	RES	1
00013	58	\$0ERR	RES	1
00014	59	\$DERR	RES	1
00015	60	\$EERR	RES	1
00016	61	IERR	RES	1
00017	62	LERR	RES	1
00020	63	\$PERR	RES	1
00021	64	\$RERR	RES	1
00022	65	\$TERR	RES	1
00023	66	\$UERR	RES	1
00024	67	\$VERR	RES	1
00025	68	\$CNTR	RES	1
00026	69	CNT1	RES	1
00027	70	CNT2	RES	1
00030	71	CNT3	RES	1
00031	72	CNTB	RES	1
00032	73	\$LN	RES	1
00033	74	BCIF	RES	1
00034	75	\$LBL1	RES	1
00035	76	\$LBL1P1	RES	1
00036	77	\$LBL1P2	RES	1

00037		78	I0C	RES	1		
00040		79	\$X	RES	1		
00041		80	Z	RES	0		
00041	00000000	81	CT	DATA	000000000		
00042	00000100	82		DATA	000000100		
00043		83	B1	RES	0		
00043	20000000	84		DATA	020000000		
00044	20000100	85		DATA	020000100		
00045		86	B3	RES	0		
00045	04000000	87		DATA	004000000		
00046	0 00 0 00120	88	\$LST	HLT	TPS		
00047	0 00 0 00112	89	LMT	HLT	TPM	LOCATION OF MNEMONIC TABLE PACKET	
00050	0 00 0 00126	90	\$LRT	HLT	TPR		
00051	0 00 0 00042	91	\$LSXT	HLT	SXT		
00052	0 00 0 00046	92	LSCX	HLT	SCXT		
00053	0 00 0 00052	93	LS0T	HLT	S0T	LOCATION OF SCAN CONNECTER	
00054	0 00 0 00072	94	LSIT	HLT	SIT	LOCATION OF SCAN ITEM	
00055	0 00 0 00034	95	LLBL	HLT	LBL1	LOCATION OF LBL	
4-15	00056	0 00 0 00000	96	FRST	HLT	MT	1ST MNEMONIC TABLE LOCATION
	00057	0 00 0 00000	97	FINL	HLT	MTE	FINAL MNEMONIC TABLE LOCATION
	00060	00000060	98	\$RCHR	DATA	060	
	00061	00000073	99	\$CCHR	DATA	073	
	00062	00000053	100	DCHR	DATA	053	
	00063	00000054	101	\$SCHR	DATA	054	*
	00064	00000007	102	\$A7	DATA	07	
	00065	00000777	103	A57	DATA	0777	
	00066	40000000	104	B0	DATA	040000000	
	00067	02000000	105	B4	DATA	020000000	
	00070	01000000	106	B5	DATA	010000000	
	00071	00400000	107	B6	DATA	040000000	
	00072	00200000	108	B7	DATA	020000000	
	00073	00100000	109	\$B8	DATA	010000000	
	00074	00010000	110	B11	DATA	010000000	
	00075	00004000	111	B12	DATA	040000000	
	00076	00002000	112	B13	DATA	020000000	
	00077	00001000	113	B14	DATA	010000000	
	00100	00000200	114	B16	DATA	020000000	
	00101	00000100	115	B17	DATA	010000000	
	00102	00000040	116	B18	DATA	040000000	

00103	00000020	117	B19	DATA	020
00104	00000010	118	B20	DATA	010
00105	00000004	119	B21	DATA	04
00106	00000002	120	B22	DATA	2
00107	00000001	121	B23	DATA	1
00110	00000077	122	C3	DATA	077
00111	77770000	123	C01	DATA	077770000
00112	00000102	124	P66	DATA	66
00113	00000030	125	P24	DATA	24
00114	00000016	126	P14	DATA	016
00115	00000012	127	P10	DATA	10
00116	00000003	128	P3	DATA	3
00117	77777777	129	M1	DATA	-1
00120	77777776	130	M2	DATA	-2
00121	77777773	131	M5	DATA	-5
00122	77777751	132	M23	DATA	-23
00123	77777721	133	M47	DATA	-47
00124	30000000	134	MC	DATA	030000000
4-16 00125	00000740	135	BPM	DATA	0740
00126	00000034	136	LL	DATA	034
	00000045	137	\$IC	EQU	B3
	00000067	138	\$CC	EQU	B4
	00000070	139	LC	EQU	B5
	00000071	140	\$SC	EQU	B6
	00000072	141	\$DC	EQU	B7
	00000073	142	\$EC	EQU	B8
	00000100	143	\$REFM	EQU	B16
	00000101	144	\$DUPM	EQU	B17
	00000106	145	\$RELM	EQU	B22
	00000107	146	EXTM	EQU	B23
	00000115	147	SPAC	EQU	P10
	00000107	148	REFT	EQU	B23
	00000106	149	DEFT	EQU	B22
00127		150	BGN	RES	0
00127	0 46 30003	151		CLR	
00130	0 35 0 00032	152		STA	LN
00131		153	BGNE	RES	0
00131	0 71 0 00056	154		LDX	FRST,X0
00132	2 77 0 00003	155		EAX	3,X2

	00133	0	37	0	00025	156		STX	CNTR,X0	
	00134	2	76	0	00001	157	RST2	LDA	1,X2	
	00135	0	72	0	00102	158		SKA	B18	TEST ASSEMBLER DEFINED
	00136	0	01	0	00150	159		BRU	RST1	DONT SAVE PROGRAMMER DEFINED
	00137	2	75	0	00000	160		LDB	0,X2	
	00140	0	36	1	00025	161		STB	*CNTR	SAVE 1ST WORD
	00141	0	61	0	00025	162		MIN	CNTR	
	00142	2	75	0	00001	163		LDB	1,X2	
	00143	0	36	1	00025	164		STB	*CNTR	SAVE 2ND WORD
	00144	0	61	0	00025	165		MIN	CNTR	
	00145	2	75	0	00002	166		LDB	2,X2	
	00146	0	36	1	00025	167		STB	*CNTR	SAVE 3RD WORD
	00147	0	61	0	00025	168		MIN	CNTR	
	00150	2	77	0	00003	169	RST1	EAX	3,X2	ADDRESS OF NEXT FROM WORD
	00151	0	76	0	00025	170		LDA	CNTR	ADDRESS OF NEXT TO WORD
	00152	1	72	0	00057	171		SKE	FINL	TEST FOR END OF COMMAND TABLE
	00153	0	01	0	00134	172		BRU	RST2	
	00154	0	71	0	01445	173	BGN2	LDX	=00200000->4,X0	
4-17	00155	0	76	0	00041	174		LDA	Z	
	00156	2	35	0	00142	175	BGN3	STA	ENDP,X2	CLEAR ALL PACKETS
	00157	0	41	0	00156	176		BRX	BGN3,X0	
	00160	0	76	0	00154	177		LDA	HIGH	HIGHEST LOCATION
	00161	0	54	0	00116	178		SUB	P3	
	00162	0	35	0	00120	179		STA	TPS	BASE OF SYMBOL TABLE
	00163	0	35	0	00121	180		STA	TPS+1	
	00164	0	76	0	00111	181		LDA	C01	
	00165	0	35	0	00123	182		STA	TPS+3	
	00166	0	35	0	00125	183		STA	TPS+5	
	00167	0	76	0	00056	184		LDA	FRST	
	00170	0	54	0	00116	185		SUB	P3	
	00171	0	35	0	00112	186		STA	TPM	BASE OF MNEMONIC TABLE
	00172	0	76	0	00111	187		LDA	C01	
	00173	0	35	0	00115	188		STA	TPM+3	
	00174	0	76	0	00057	189		LDA	FINL	
	00175	0	54	0	00056	190		SUB	FRST	
	00176	0	71	0	00113	191		LDX	P24,X0	
	00177	0	35	0	00025	192		STA	CNTR	NO. OF WORDS IN TABLE
	00200	0	67	10	030	193		N0D	24	
	00201	0	14	0	00124	194		ETR	MC	

00202	0	54	0	00045	195	SUB	B3	
00203	0	72	0	00043	196	SKA	B1	
00204	0	55	0	00045	197	ADD	B3	
00205	0	46	20005		198	ABC		
00206	2	6700	000		199	LSH	0,X2	
00207	0	35	0	00114	200	STA	TPM+2	
00210	0	76	0	00025	201	LDA	CNTR	
00211	0	54	0	00114	202	SUB	TPM+2	
00212	0	35	0	00116	203	STA	TPM+4	
00213	0	55	0	00056	204	ADD	FRST	
00214	0	35	0	00113	205	STA	TPM+1	
00215	0	76	0	00041	206	LDA	Z	
00216	0	35	0	00153	207	STA	PASS	SET PASS1
00217	0	35	0	00151	208	STA	CTYP	
00220	0	76	0	00051	209	LDA	LSXT	
* 00221	0	35	0	00000	210	STA	SCNX	SET SCAN EXIT
* 00222	0	76	0	00052	211	LDA	LSCX	
* 00223	0	35	0	00000	212	STA	SCIX	
* 4-18 00224	0	76	0	00053	213	LDA	LSOT	
* 00225	0	35	0	00000	214	STA	LOP	SET SCAN CONNECTER
* 00226	0	76	0	00054	215	LDA	LSIT	
* 00227	0	35	0	00000	216	STA	LITM	SET SCAN ITEM
00230	0	76	0	00057	217	LDA	FINL	1ST AVAILABLE CELL
00231	0	54	0	00154	218	SUB	HIGH	
00232	0	35	0	00155	219	STA	LIMT	MINUS NO. OF CELLS AVAILABLE
00233	0	00	0	00000	220	HLT		
00234	0	76	0	00041	221	BGN4 LDA	Z	
* 00235	0	35	0	00000	222	STA	MLOC	0 TO MAX LOC
* 00236	0	35	0	00000	223	STA	ALN	
00237	0	76	0	00073	224	LDA	B8	
00240	0	35	0	00142	225	STA	L8C	
00241	0	76	0	00041	226	LINE LDA	Z	
00242	0	35	0	00143	227	STA	PMED	
00243	0	35	0	00144	228	STA	WMOD	0 TO MODE
00244	0	35	0	00002	229	STA	XFLG	RESET EXTERNAL FLAG
00245	0	35	0	00003	230	STA	IFLG	RESET INDIRECT FLAG
00246	0	35	0	00034	231	STA	LBI1	RESET LABEL
00247	0	35	0	00152	232	STA	STYP	
00250	0	35	0	00017	233	STA	LERR	

	00251	0	76	0	00117	234	LDA	M1	
	00252	0	35	0	00031	235	STA	6CTF	RESET OCTAL FLAG
	00253	0	76	0	00122	236	LDA	M23	
*	00254	0	35	0	00000	237	STA	SCALE	
	00255	0	76	0	00126	238	LDA	LL	
*	00256	0	35	0	00000	239	STA	EDCT	
*	00257	0	43	0	00000	240	BRM	READ	READ LINE
	00260	1	72	0	00060	241	SKE	BCHR	TEST FOR BLANK LABEL
	00261	0	01	0	00434	242	BRU	LIN1	PROCESS LABEL FIELD
*	00262	0	43	0	00000	243	BRM	FLD	SKIP TO OPERATION
	00263	1	72	0	00060	244	SKE	BCHR	
	00264	0	01	0	00267	245	BRU	LP1	
	00265	0	43	0	00550	246	BRM	LXL	
	00266	0	01	0	00436	247	BRU	LIN10	
*	00267	0	43	0	00000	248	BRM	SYM	
*	00270	0	76	0	00000	249	LDA	CHR	
	00271	1	72	0	00063	250	SKE	SCHR	TEST FOR *
	00272	1	73	0	00003	251	SKR	IFLG	
4-19	00273	0	61	0	00003	252	MIN	IFLG	SET I FLAG
	00274	1	72	0	00063	253	SKE	SCHR	
	00275	0	53	0	00117	254	SKN	M1	ALWAYS SKIP
*	00276	0	43	0	00000	255	BRM	GET	SKIP *
	00277	1	72	0	00060	256	SKE	BCHR	TEST FOR BLANK
*	00300	0	35	0	00000	257	STA	SM1	UNDEFINED COMMAND
*	00301	0	76	0	00000	258	LDA	LSYM	
	00302	0	75	0	00047	259	LDB	LMT	
*	00303	0	43	0	00000	260	BRM	SRCH	LOOK UP MNEMONIC
*	00304	0	01	0	00000	261	BRU	POPI	
	00305	0	35	0	00145	262	SPOPIRT STA	WORD	
	00306	0	36	0	00010	263	STB	MODE	SAVE TYPE
*	00307	0	43	0	00262	264	BRM	FLD	SKIP TO OPERAND FIELD
	00310	0	76	0	00010	265	LDA	MODE	
	00311	0	72	0	00105	266	SKA	B21	
	00312	0	01	1	00145	267	BRU	*WORD	
	00313	0	43	0	00315	268	BRM	DLBL	DEFINE LABEL
	00314	0	01	0	00335	269	BRU	LIN7	
	00315	0	00	0	00000	270	DLBL	HLT	0
	00316	0	76	0	00034	271	LDA	LBL1	
	00317	1	72	0	00041	272	SKE	Z	

	00320	1	72	0	00034	273		SKE	LBL1	
	00321	0	51	0	00315	274		BRR	DLBL	EXIT
	00322	0	76	0	00035	275		LDA	LBL1+1	
	00323	0	75	0	00142	276		LDB	L0C	
	00324	0	36	0	00036	277		STB	LBL1+2	
	00325	0	43	0	01432	278		BRM	SKR	
	00326	0	00	0	00073	279		HLT	B8	
	00327	0	16	0	00106	280		MRG	B22	
	00330	0	35	0	00035	281		STA	LBL1+1	
	00331	0	76	0	00055	282		LDA	LLBL	
	00332	0	75	0	00046	283		LDB	LST	
*	00333	0	43	0	00000	284		BRM	NSRT	INSERT IN SYMBOL TABLE
	00334	0	51	0	00315	285		BRR	DLBL	EXIT LABEL DEFINE
	00335	0	76	0	00010	286	LIN7	LDA	MODE	
	00336	0	72	0	00106	287		SKA	B22	
	00337	0	01	1	00145	288		BRU	*WORD	
	00340	0	53	0	00153	289		SKN	PASS	
	00341	0	01	0	00432	290		BRU	LIN2	1ST PASS
4-20	00342	0	72	0	00076	291		SKA	B13	
*	00343	0	01	0	00000	292		BRU	P0PR	
	00344	0	72	0	00107	293		SKA	B23	
	00345	0	01	0	01343	294		BRU	FREF	
	00346	0	72	0	00104	295		SKA	B20	
	00347	0	01	0	00442	296		BRU	INR3	
	00350	0	75	0	00117	297		LDB	M1	
	00351	0	72	0	00103	298		SKA	B19	
*	00352	0	75	0	00000	299		LDB	FORCE0	
	00353	0	36	0	00001	300		STB	0CTF	OCTAL ADDRESS
*	00354	0	43	0	00000	301	INR1	BRM	SCNL	GET INSTRUCTION ADDRESS
	00355	0	02	20001		302	INR1A	R0V		
*	00356	0	71	0	00000	303		LDX	NAR,X0	
	00357	2	6700	000		304		LSH	0,X2	
	00360	2	6600	000		305		RSH	0,X2	
*	00361	0	14	0	00000	306		ETR	ADDR	
	00362	0	16	0	00145	307		MRG	WORD	
	00363	0	40	20001		308	INR9	0VT		
	00364	0	61	0	00022	309		MIN	TERR	SET T ERROR
	00365	0	36	0	00144	310		STB	W0D	
	00366	0	75	0	01446	311		LDB	=07700000	

*	00367	0	70	0	00000	312		SKM	E0D	
	00370	0	01	0	00372	313		BRU	INR93	
	00371	0	01	0	00374	314		BRU	INR92	
*	00372	0	70	0	00000	315	INR93	SKM	E0M	
	00373	0	01	0	00404	316		BRU	INR91	
	00374	0	53	0	00003	317	INR92	SKN	IFLG	
	00375	0	16	0	01447	318		MRG	=040000	
	00376	0	01	0	00406	319		BRU	INR94	
	00377	0	53	0	00153	320	\$PZE	SKN	PASS	
	00400	0	01	0	00432	321		BRU	LIN2	
*	00401	0	43	0	00354	322		BRM	SCNL	
	00402	0	36	0	00144	323		STB	WM0D	
	00403	0	14	0	01450	324		ETR	=077777	
	00404	0	53	0	00003	325	INR91	SKN	IFLG	
*	00405	0	16	0	00000	326		MRG	INDB	SET INDIRECT BIT
	00406	0	35	0	00145	327	INR94	STA	WORD	
	00407	0	76	0	00117	328		LDA	M1	
	00410	0	35	0	00001	329		STA	0CTF	RESET OCTAL FLAG
4-21	00411	0	76	0	00150	330		LDA	TERM	
	00412	1	72	0	00061	331		SKE	CCHR	
	00413	0	01	0	00423	332		BRU	LIN3	
*	00414	0	43	0	00000	333		BRM	SCAN	GET INDEX
*	00415	0	14	0	00000	334		ETR	XMSK	MASK X FIELD
	00416	1	72	0	00011	335		SKE	VALU	
	00417	0	61	0	00022	336		MIN	TERR	SET TRUNCATION ERROR
	00420	0	6700	025		337		LSH	21	POSITION X FIELD
	00421	0	16	0	00145	338	\$INR2	MRG	WORD	
	00422	0	35	0	00145	339		STA	WORD	INSERT INDEX
*	00423	0	76	0	00000	340	\$LIN3	LDA	INST	
	00424	0	35	0	00146	341		STA	WRD2	INSTRUCTION FORM
	00425	0	76	0	00060	342	LIN8	LDA	BCHR	
	00426	1	72	0	00150	343		SKE	TERM	TEST FOR BLANK
	00427	0	61	0	00015	344		MIN	EERR	SET ERROR
	00430	0	35	0	00150	345		STA	TERM	
*	00431	0	43	0	00000	346		BRM	EDIT	EDIT INSTRUCTION
	00432	0	61	0	00142	347	\$LIN2	MIN	L0C	L+1 TO L
	00433	0	01	0	00241	348		BRU	LINE	
	00434	1	72	0	00063	349	LIN1	SKE	SCHR	TEST FOR *
	00435	0	01	0	00510	350		BRU	LIN4	

	00436				351	\$NOP0	RES	0	
	00436	0	53	0	00153	352	LIN10	SKN	PASS
	00437	0	01	0	00241	353		BRU	LINE
									SKIP IF 1ST PASS
*	00440	0	43	0	00000	354		BRM	PRNT
									PRINT COMMENTS LINE
	00441	0	01	0	00241	355		BRU	LINE
	00442	0	76	0	00010	356	INR3	LDA	MODE
	00443	0	72	0	00075	357		SKA	B12
	00444	0	01	0	00446	358		BRU	\$+2
	00445	0	01	0	00467	359		BRU	INR31
*	00446	0	43	0	00414	360		BRM	SCAN
	00447	0	75	0	00041	361		LDB	Z
	00450	0	72	0	00105	362		SKA	B21
*	00451	0	75	0	00367	363		LDB	E0D
	00452	0	14	0	00116	364		ETR	P3
	00453	1	66	0	00000	365		CAX	
	00454	0	46	10	0012	366		BAC	
	00455	2	16	0	00041	367		MRG	CT,X2
	00456	0	16	0	00145	368		MRG	WORD
4-22	00457	0	75	0	01446	369		LDB	=07700000
*	00460	0	70	0	00000	370		SKM	SKSE0D
	00461	0	01	0	00463	371		BRU	\$+2
*	00462	0	17	0	00000	372		E0R	E0DI
	00463	0	35	0	00145	373		STA	WORD
	00464	0	76	0	00150	374		LDA	TERM
	00465	1	72	0	00061	375		SKE	CCHR
	00466	0	01	0	00423	376		BRU	LIN3
	00467	0	76	0	01447	377	INR31	LDA	=040000
	00470	0	53	0	00003	378		SKN	IFLG
	00471	1	76	0	00145	379		ADM	WORD
*	00472	0	43	0	00446	380		BRM	SCAN
	00473	0	14	0	00110	381		ETR	C3
	00474	1	72	0	00011	382		SKE	VALU
	00475	0	61	0	00022	383		MIN	TERR
	00476	1	76	0	00145	384		ADM	WORD
	00477	0	76	0	00150	385		LDA	TERM
	00500	1	72	0	00061	386		SKE	CCHR
	00501	0	01	0	00423	387		BRU	LIN3
*	00502	0	43	0	00472	388		BRM	SCAN
	00503	1	72	0	00041	389		SKE	Z
									NS CHARACTER COUNT
									GET CHAR/WORD

	00504	0 54 0 00107	390		SUB	B23	
	00505	0 14 0 00116	391		ETR	P3	
	00506	0 6700 007	392		LSH	7	POSITION CHAR/WORD
	00507	0 01 0 00421	393		BRU	INR2	
	00510	1 72 0 00062	394	LIN4	SKE	DCHR	TEST FOR \$
	00511	0 01 0 00515	395		BRU	LIN5	
	00512	0 53 0 00153	396		SKN	PASS	
	00513	0 61 0 00002	397		MIN	XFLG	SET EXTERNAL FLAG
*	00514	0 43 0 00276	398	LIN49	BRM	GET	
	00515	0 75 0 00071	399	LIN5	LDB	SC	CHECK FOR LABEL CHARACTER
	00516	0 73 0 00041	400		SKG	Z	
	00517	0 61 0 00017	401		MIN	LERR	1ST CHAR = 0 ←
	00520	0 43 0 01432	402		BRM	SKB	
*	00521	2 00 0 00000	403		HLT	CTT,X2	
	00522	0 01 0 00524	404		BRU	LIN9	
	00523	0 61 0 00017	405	LIN11	MIN	LERR	SET LABEL FIELD ERROR FLAG
*	00524	0 43 0 00267	406	LIN9	BRM	SYM ←	
	00525	0 35 0 00034	407		STA	LBL1	SAVE
4-23	00526	1 65 0 00000	408		CBA		
	00527	0 16 0 00002	409		MRG	XFLG	SET EXTERNAL MODE
	00530	0 35 0 00035	410		STA	LBL1+1	
	00531	0 16 0 00034	411		MRG	LBL1	
*	00532	0 72 0 00000	412		SKA	DLY1	TDST FOR AT LEAST 1 ALPHABETEC
	00533	0 53 0 00117	413		SKN	M1	ALWAYS SKIP
	00534	0 61 0 00017	414		MIN	LERR	ALL NUMERIC
*	00535	0 76 0 00270	415		LDA	CHR	
	00536	1 72 0 01451	416		SKE	=','	
	00537	0 01 0 00542	417		BRU	LIN99	
	00540	0 43 0 00550	418		BRM	LXL	
	00541	0 01 0 00514	419		BRU	LIN49	
	00542	1 72 0 00060	420	LIN99	SKE	BCHR	
	00543	0 61 0 00017	421		MIN	LERR	ILLEGAL CHARACTER IN LABEL
	00544	0 76 0 00041	422		LDA	Z	
	00545	1 72 0 00017	423		SKE	LERR	TEST FOR LABEL ERROR
	00546	0 35 0 00034	424		STA	LBL1	DONT ENTER LABEL
	00547	0 01 0 00262	425		BRU	LIN6	
	00550	0 00 0 00000	426	LXL	HLT	0	
	00551	0 76 0 00055	427		LDA	LLRL	
	00552	0 75 0 00046	428		LDB	LST	

* 00553	0	43	0	00303	429	BRM	SRCH	
00554	0	51	0	00550	430	BRR	LXL	
00555	1	65	0	00000	431	CBA		
00556	0	16	0	00002	432	MRG	XFLG	
00557	2	35	0	00001	433	STA	1.X2	
00560	0	51	0	00550	434	BRR	LXL	
* 00561	0	43	0	00502	435	\$EQU BRM	SCAN	GET VALUE
00562	0	35	0	00145	436	STA	WORD	
00563	0	46	0	00014	437	XAB		
00564	0	14	0	00120	438	ETR	M2	
00565	1	76	0	00035	439	ADM	LBL1+1	
00566	0	36	0	00036	440	STB	LBL1+2	
00567	0	76	0	00055	441	LDA	LLRL	
00570	0	75	0	00046	442	LDB	LST	
* 00571	0	43	0	00333	443	EQU1 BRM	NSRT	INSERT IN SYMBOL TABLE
00572	0	53	0	00153	444	EQU2 SKN	PASS	
00573	0	01	0	00241	445	BRU	LINE	
* 00574	0	43	0	00000	446	BRM	EDTV	PRINT
4-24 00575	0	01	0	00241	447	BRU	LINE	
* 00576	0	76	0	00352	448	\$OPD LDA	FORCE0	
00577	0	35	0	00001	449	STA	OCTF	SET OCTAL FLAG
* 00600	0	43	0	00561	450	BRM	SCAN	GET VALUE
00601	0	35	0	00145	451	STA	WORD	
00602	0	35	0	00036	452	STA	LBL1+2	
00603	0	76	0	00102	453	LDA	B18	
00604	1	76	0	00035	454	ADM	LBL1+1	
00605	0	76	0	00055	455	OPD1 LDA	LLBL	
00606	0	75	0	00047	456	LDB	LMT	
* 00607	0	43	0	00571	457	BRM	NSRT	
00610	0	14	0	01452	458	ETR	=07777	
00611	1	72	0	01453	459	SKE	=02140	
00612	0	01	0	00572	460	BRU	EQU2	
00613	0	76	0	00035	461	LDA	LBL1+1	
00614	2	35	0	00001	462	STA	1.X2	
00615	0	76	0	00036	463	LDA	LBL1+2	
00616	2	35	0	00002	464	STA	2.X2	
00617	0	01	0	00572	465	BRU	EQU2	
00620	0	46	0	30003	466	\$FORM CLR		
00621	0	36	0	00146	467	FRM3 STB	WRD2	STORE FORM WORD

	00622	0 43 0	00600	468	BRM	SCAN	GET FIELD LENGTH
	00623	1 66 0	00000	469	CAX		
	00624	0 75 0	00146	470	LDB	WRD2	
	00625	0 76 0	00066	471	LDA	BO	
	00626	2 6720	000	472	LCY	O,X2	INSERT NEW FIELD
	00627	0 72 0	00117	473	SKA	M1	
	00630	0 01 0	00640	474	BRU	FRM1	MORE THAN 24 BITS
	00631	0 43 0	01432	475	BRM	SKP	
	00632	0 00 0	00066	476	HLT	BO	
	00633	0 01 0	00641	477	BRU	FRM2	END OF FORM
	00634	0 76 0	00150	478	LDA	TERM	
	00635	1 72 0	00061	479	SKE	CCHR	
	00636	0 01 0	00640	480	BRU	FRM1	LESS THAN 24 BITS
	00637	0 01 0	00621	481	BRU	FRM3	PROCESS NEST FIELD
	00640	0 61 0	00022	482	FRM1 MIN	TERR	SET TRUNCATION ERROR
	00641	1 65 0	00000	483	FRM2 CBA		
	00642	0 16 0	00066	484	MRG	BO	
	00643	0 35 0	00036	485	STA	LBL1+2	
4-25	00644	0 76 0	00107	486	LDA	B23	
	00645	0 55 0	00102	487	ADD	B18	
	00646	1 76 0	00035	488	ADM	LBL1+1	
	00647	0 76 0	00055	489	LDA	LLBL	
	00650	0 75 0	00047	490	LDB	LMT	
*	00651	0 43 0	00607	491	BRM	NSRT	INSERT FORM ITEM
	00652	0 53 0	00153	492	SKN	PASS	
	00653	0 01 0	00241	493	BRU	LINE	SKIP IF PASS 1
*	00654	0 43 0	00000	494	BRM	EDE	EDIT ERRORS
*	00655	0 43 0	00440	495	FRM4 BRM	PRNT	
	00656	0 01 0	00241	496	BRU	LINE	
	00657	0 53 0	00153	497	\$PAGE SKN	PASS	
	00660	0 01 0	00241	498	BRU	LINE	DONT EJECT IF PASS 1
*	00661	0 43 0	00000	499	BRM	HOME	EJECT TO NEXT PAGE
*	00662	0 43 0	00655	500	BRM	PRNT	
	00663	0 01 0	00241	501	BRU	LINE	
	00664	0 46	30003	502	\$AORG CLR		
	00665	0 01 0	00667	503	BRU	ORG1	
	00666	0 76 0	00073	504	\$ORG LDA	B8	
	00667	0 43 0	00673	505	ORG1 BRM	ILOC	GET NEW LOC
	00670	0 35 0	00142	506	STA	LOC	

	00671	0	43	0	00315	507	BRM	DLBL	DEFINE LABEL
	00672	0	01	0	00704	508	BRU	BSS1	
	00673	0	00	0	00000	509	IL0C	HLT	0
	00674	0	35	0	00156	510	STA	L0C1	
*	00675	0	43	0	00000	511	BRM	MAXL	SET MAXIMUM L0C
*	00676	0	43	0	00622	512	BRM	SCAN	GET INCREMENT
	00677	0	55	0	00156	513	ADD	L0C1	
	00700	0	35	0	00156	514	STA	L0C1	SAVE RESULT
	00701	0	51	0	00673	515	BRR	IL0C	EXIT
	00702	0	76	0	00142	516	\$BSS	LDA	L0C
	00703	0	43	0	00673	517	BRM	IL0C	OLD L0C
	00704	0	53	0	00153	518	BSS1	SKN	GET NEW L0C
	00705	0	53	0	00117	519	SKN	M1	TEST PASS
*	00706	0	43	0	00000	520	BRM	EDTL	DONT PRINT IF 1ST PASS
	00707	0	76	0	00156	521	LDA	L0C1	PRINT LOCATION
	00710	0	35	0	00142	522	STA	L0C	NEW LOCATION
	00711	0	01	0	00241	523	BRU	LINE	
*	00712	0	43	0	00676	524	\$DATA	BRM	SCAN
4-26	00713	0	53	0	00153	525	SKN	PASS	
	00714	0	01	0	00722	526	BRU	DATA1	
	00715	0	35	0	00145	527	STA	WORD	
	00716	0	36	0	00144	528	STB	WORD	
	00717	0	76	0	00066	529	LDA	B0	
	00720	0	35	0	00146	530	STA	WRD2	
*	00721	0	43	0	00431	531	BRM	EDIT	
	00722	0	61	0	00142	532	DATA1	MIN	L0C
	00723	0	76	0	00150	533	LDA	TERM	
	00724	1	72	0	00061	534	SKE	CCHR	
	00725	0	01	0	00241	535	BRU	LINE	
	00726	0	01	0	00712	536	BRU	DATA	
	00727	0	76	0	00123	537	\$DED	LDA	M47
*	00730	0	35	0	00254	538	STA	SCALE	SCALE
*	00731	0	43	0	00000	539	BRM	DPW	GET DOUBLE PRECISION WORD
*	00732	0	23	0	00000	540	EXU	DPWR	TO EXCHANGE OR NOT TO EXCHANGE
	00733	0	36	0	00145	541	STB	WORD	
	00734	0	35	0	00011	542	STA	VALU	
	00735	0	53	0	00153	543	SKN	PASS	
	00736	0	01	0	00742	544	BRU	DED1	
	00737	0	76	0	00066	545	LDA	B0	

	00740	0	35	0	00146	546	STA	WRD2
*	00741	0	43	0	00721	547	BRM	EDIT
	00742	0	61	0	00142	548	DED1	L9C
	00743	0	53	0	00153	549	SKN	PASS
	00744	0	01	0	00752	550	BRU	DED2
	00745	0	76	0	00011	551	LDA	VALU
	00746	0	35	0	00145	552	STA	WORD
	00747	0	76	0	00066	553	LDA	BO
	00750	0	35	0	00146	554	STA	WRD2
*	00751	0	43	0	00741	555	BRM	EDIT
	00752	0	61	0	00142	556	DED2	L9C
	00753	0	76	0	00150	557	LDA	TERM
	00754	1	72	0	00051	558	SKE	CCHR
	00755	0	01	0	00241	559	BRU	LINE
	00756	0	01	0	00727	560	BRU	DED
	00757					561	\$RCD	RES 0
	00757	0	75	0	00115	562	LDB	SPAC
	00760	0	01	0	00762	563	BRU	\$+2
4-27	00761					564	\$TEXT	RES 0
	00761	0	75	0	00060	565	LDB	BCHR
	00762	0	36	0	00033	566	STB	BCIF
*	00763	0	76	0	00535	567	LDA	CHR
	00764	1	72	0	01454	568	SKE	=<<
	00765	0	01	0	00772	569	BRU	TEXT7
	00766	0	76	0	00114	570	LDA	P14
	00767	0	35	0	00150	571	STA	TERM
	00770	0	76	0	01455	572	LDA	=55
	00771	0	01	0	01002	573	BRU	TEXT6
*	00772	0	43	0	00000	574	TEXT7	BRM DECW
	00773	0	54	0	00107	575	TEXT1	SUB B23
	00774	0	75	0	00101	576	LDB	B17
	00775	0	36	0	00150	577	STB	TERM
	00776	0	73	0	01455	578	SKG	=55
	00777	0	01	0	01002	579	BRU	TEXT6
	01000	0	76	0	01455	580	LDA	=55
	01001	0	61	0	00022	581	MIN	TERR
	01002	0	35	0	00031	582	TEXT6	STA CNTB
*	01003	0	43	0	00514	583	BRM	GET
	01004	U	53	0	00031	584	TEXT2	SKN CNTB

	01005	0	53	0	00117	585		SKN	M1	ALWAYS SKIP
	01006	0	01	0	00241	586		BRU	LINE	DONE
	01007	0	76	0	00033	587		LDA	BCIF	
	01010	1	74	0	01456	588		MUL	=01010101	
	01011	0	6700	027		589		LSH	23	
	01012	0	35	0	00145	590		STA	WORD	SET WORD TO BLANKS
	01013	0	71	0	01457	591		LDX	=00200000-4,X0	
*	01014	0	76	0	00763	592	TEXT3	LDA	CHR	
	01015	1	72	0	00060	593		SKE	BCHR	
	01016	0	01	0	01020	594		BRU	\$+2	
	01017	0	76	0	00033	595		LDA	BCIF	
	01020	1	72	0	00150	596		SKE	TERM	
	01021	0	01	0	01025	597		BRU	TEXT8	
	01022	1	71	0	00000	598		CNA		
	01023	0	35	0	00031	599		STA	CNTB	
	01024	0	01	0	01036	600		BRU	TEXT4	
	01025	0	54	0	00033	601	TEXT8	SUB	BCIF	
	01026	0	75	0	00041	602		LDB	Z	
4-28	01027	2	23	0	01051	603		EXU	TEXT5,X2	EXECUTE SHIFT
	01030	1	76	0	00145	604		ADM	WORD	ADD CHARACTER TO WORD
	01031	0	37	0	00025	605		STX	CNTR,X0	
*	01032	0	43	0	01003	606		BRM	GET	
	01033	0	71	0	00025	607		LDX	CNTR,X0	
	01034	1	73	0	00031	608		SKR	CNTB	
	01035	0	41	0	01014	609		BRX	TEXT3,X0	
	01036	0	76	0	00066	610	TEXT4	LDA	B0	
	01037	0	35	0	00146	611		STA	WRD2	
	01040	0	53	0	00153	612		SKN	PASS	
	01041	0	53	0	00117	613		SKN	M1	YES
*	01042	0	43	0	00751	614		BRM	EDIT	EDIT ALPHA-NUMERIC WORD
	01043	0	61	0	00142	615		MIN	L0C	L+1 TO L
	01044	0	01	0	01004	616		BRU	TEXT2	
	01045	0	6700	022		617		LSH	18	
	01046	0	6700	014		618		LSH	12	
	01047	0	6700	006		619		LSH	6	
	01050	0	20	0	00000	620		N0P	0	
	01051					621	TEXT5	RES	0	
	01051	0	76	0	00041	622	ENDPS	LDA	Z	
	01052	0	35	0	00153	623		STA	PASS	FORCE END OF PASS 1

	01053				624	\$END	RES	0	
	01053	0	53	0	00153	625	END1A	SKN	PASS
	01054	0	01	0	01056	626		BRU	END1
	01055	0	01	0	01173	627		BRU	END2
	01056					628	END1	RES	0
*	01056	0	43	0	00000	629		BRM	ENDS1
	01057	0	76	0	00117	630		LDA	M1
	01060	0	35	0	00153	631		STA	PASS
	01061	0	76	0	00142	632		LDA	L0C
	01062	0	35	0	00157	633		STA	L0CP
	01063	0	35	0	00000	634		STA	LADD
*	01064	0	71	0	00000	635		LDX	ERRC,X0
	01065	0	76	0	00041	636		LDA	Z
	01066	2	35	0	00024	637	END3	STA	VERR,X2
	01067	0	41	0	01066	638		BRX	END3,X0
	01070	0	35	0	00024	639		STA	VERR
*	01071	0	35	0	00000	640		STA	DWC
	01072	0	76	0	00106	641		LDA	DEFT
4-29	01073	0	35	0	00152	642		STA	STYP
	01074	0	76	0	00107	643		LDA	B23
	01075	0	35	0	00151	644		STA	CTYP
	01076	0	71	0	00120	645		LDX	TPS,X0
	01077	1	67	0	00000	646	END14	CXA	
	01100	0	55	0	00116	647		ADD	P3
	01101	0	73	0	00154	648		SKG	HIGH
	01102	0	53	0	00117	649		SKN	M1
	01103	0	01	0	01120	650		BRU	END13
	01104	1	66	0	00000	651		CAX	
	01105	2	76	0	00001	652		LDA	1,X2
	01106	0	72	0	00107	653		SKA	EXTM
	01107	0	53	0	00117	654		SKN	M1
	01110	0	01	0	01077	655		BRU	END14
	01111	0	14	0	00120	656		ETR	M2
	01112	2	35	0	00001	657		STA	1,X2
	01113	0	37	0	00145	658		STX	WORD,X0
	01114	0	37	0	00025	659		STX	CNTR,X0
*	01115	0	43	0	00000	660		BRM	6UTP
	01116	0	71	0	00025	661		LDX	CNTR,X0
	01117	0	01	0	01077	662		BRU	END14

	01120	0	76	0	00041	663	END13	LDA	Z	
	01121	0	35	0	00005	664		STA	LTR1	
	01122	0	76	0	00106	665		LDA	B22	
	01123	0	35	0	00151	666		STA	CTYP	
	01124	0	76	0	00112	667		LDA	TPM	
	01125	0	55	0	00114	668		ADD	TPM+2	
	01126	0	55	0	00116	669		ADD	TPM+4	
	01127	0	35	0	00134	670		STA	TPL	ORIGIN OF LIETERL TABLE
	01130	0	71	0	00056	671		LDX	FRST,X0	
	01131	2	77	0	00003	672		EAX	3,X2	
	01132	0	37	0	00025	673	ENDP2	STX	CNTR,X0	
	01133	2	76	0	00001	674		LDA	1,X2	
	01134	0	75	0	01452	675		LDB	=07777	
	01135	0	70	0	01460	676		SKM	=02040	
	01136	0	01	0	01146	677		BRU	ENDP1	
	01137	2	76	0	00002	678		LDA	2,X2	
	01140	0	6620	020		679		RCY	16	
	01141	0	16	0	00005	680		MRG	LTR1	
4-30	01142	0	6720	020		681		LCY	16	
	01143	2	35	0	00002	682		STA	2,X2	
	01144	0	61	0	00005	683		MIN	LTR1	
*	01145	0	43	0	01115	684		BRM	0UTP	
	01146	0	71	0	00025	685	ENDP1	LDX	CNTR,X0	
	01147	2	77	0	00003	686		EAX	3,X2	
	01150	1	67	0	00000	687		CXA		
	01151	1	72	0	00134	688		SKE	TPL	
	01152	0	01	0	01132	689		BRU	ENDP2	
	01153	0	76	0	00041	690		LDA	Z	
	01154	0	35	0	00151	691		STA	CTYP	
	01155	0	76	0	00120	692		LDA	TPS	
	01156	0	35	0	00126	693		STA	TPR	ORIGIN OF REFERENCE TABLE
	01157	0	35	0	00127	694		STA	TPR+1	
	01160	0	76	0	00111	695		LDA	CO1	
	01161	0	35	0	00131	696		STA	TPR+3	
	01162	0	35	0	00133	697		STA	TPR+5	
	01163	0	35	0	00135	698		STA	TPL+1	
	01164	0	76	0	00117	699		LDA	M1	
	01165	0	35	0	00137	700		STA	TPL+3	
*	01166	0	76	0	00532	701		LDA	DLY1	

	01167	0	71	0	01461	702	LDX	=00200000-R,X0	
*	01170	2	35	0	00000	703	END8	STA	CRUF,X2 CLEAR PRINT LINE
	01171	0	41	0	01170	704		BRX	END8,X0
	01172	0	01	0	00234	705		BRU	BGN4
	01173	0	76	0	00107	706	END2	LDA	B23
	01174	0	35	0	00004	707		STA	EFLG
*	01175	0	76	0	01014	708		LDA	CHR
	01176	1	72	0	00060	709		SKE	BCPR
	01177	0	53	0	00117	710		SKN	M1 ALWAYS SKIP
	01200	0	01	0	01210	711		BRU	END4 NO TRANSFER
*	01201	0	43	0	00712	712		BRM	SCAN GET TRANSFER ADDRESS
	01202	0	35	0	00145	713		STA	WORD
	01203	0	76	0	00066	714		LDA	B0
	01204	0	35	0	00146	715		STA	WRD2
*	01205	0	43	0	00574	716		BRM	EDTV EDITT
	01206	1	73	0	00004	717		SKR	EFLG SET TRANSFER FLAG
	01207	0	01	0	01211	718		BRU	END5
*	01210	0	43	0	00662	719	END4	BRM	PRNT PRINT
	01211	0	71	0	00134	720	END5	LDX	TPL,X0 LIT TABLE ORIGIN
4-31	01212	0	76	0	00157	721		LDA	L&CP
	01213	0	35	0	00142	722		STA	L&C
	01214	0	35	0	00005	723		STA	LTR1 0 TO SEQUENCE
	01215	1	72	0	00000	724	END6	SKE	LADD
	01216	0	01	0	01275	725		BRU	PLTR LITERAL TO OUTPUT
*	01217	0	43	0	00675	726		BRM	MAXL MAXIMUM LOCATION
	01220	0	76	0	00107	727		LDA	REFT
	01221	0	35	0	00152	728		STA	STYP
	01222	0	76	0	00107	729		LDA	B23
	01223	0	35	0	00151	730		STA	CTYP
	01224	0	71	0	00050	731		LDX	LRT,X0 1ST WORD OF REF TABLE
	01225	2	76	0	00000	732		LDA	0,X2
	01226	0	55	0	00116	733		ADD	P3
	01227	0	35	0	00005	734		STA	LTR1
	01230	2	55	0	00002	735		ADD	2,X2
	01231	2	55	0	00004	736		ADD	4,X2
	01232	0	35	0	00006	737		STA	LTR2 END OF REF TABLE
	01233	0	76	0	00006	738	END12	LDA	LTR2
	01234	0	73	0	00005	739		SKG	LTR1
	01235	0	01	0	01256	740		BRU	END15 NO MORE REFS

	01236	0	76	0	00005	741	LDA	LTR1	
	01237	0	35	0	00145	742	STA	WORD	
	01240	0	76	1	00005	743	LDA	*LTR1	
*	01241	0	35	0	00000	744	STA	EREF1	
	01242	0	61	0	00005	745	MIN	LTR1	
	01243	0	76	1	00005	746	LDA	*LTR1	
	01244	0	14	0	00111	747	ETR	CO1	
	01245	0	16	0	01462	748	MRG	= ' '	
*	01246	0	35	0	00000	749	STA	EREF2	
	01247	0	61	0	00005	750	MIN	LTP1	
	01250	0	76	1	00005	751	LDA	*LTR1	
	01251	0	61	0	00005	752	MIN	LTR1	
	01252	0	35	0	00142	753	STA	L0C	
*	01253	0	43	0	00706	754	BRM	EDTL	
*	01254	0	43	0	01145	755	BRM	0UTP	0UTPUT REF
	01255	0	01	0	01233	756	BRU	END12	
	01256	0	76	0	00116	757	LDA	P3	END CARD TYPE
	01257	0	35	0	00151	758	STA	CTYP	
4-32	01260	1	73	0	00004	759	SKR	EFLG	
	01261	0	01	0	01267	760	BRU	END7	NS TRANSFER
	01262	0	76	0	00011	761	LDA	VALU	
	01263	0	35	0	00145	762	STA	WORD	ADDRESS
	01264	0	76	0	00010	763	LDA	MODE	
	01265	0	35	0	00144	764	STA	WM0D	
*	01266	0	43	0	01254	765	BRM	0UTP	0UTPUT TRANSFER CARD
	01267	0	76	0	00105	766	LDA	B21	
	01270	0	35	0	00151	767	STA	CTYP	
*	01271	0	43	0	01266	768	BRM	0UTP	CLEAR CARDS
	01272					769	RES	0	
*	01272	0	43	0	00661	770	BRM	H0ME	
*	01273	0	43	0	00000	771	BRM	WE0F	
	01274	0	01	0	00127	772	BRU	BGN	
	01275	1	67	0	00000	773	PLTR	CXA	
	01276	0	55	0	00116	774	ADD	P3	CURRENT SEQUENCE
	01277	1	66	0	00000	775	CAX		
	01300	2	76	0	00002	776	LDA	2,X2	
	01301	1	72	0	00005	777	PLT2	SKE	LTR1
	01302	0	01	0	01320	778	BRU	PLT1	0UT 0F SEQUENCE
	01303	2	76	0	00000	779	LDA	0,X2	

01304	0	35	0	00145	780	STA	WORD	VALUE
01305	2	76	0	00001	781	LDA	1,X2	
01306	0	35	0	00144	782	STA	WORD	MODE
01307	0	76	0	00066	783	LDA	BO	
01310	0	35	0	00146	784	STA	WRD2	
01311	0	37	0	00006	785	STX	LTR2,XO	
* 01312	0	43	0	01042	786	BRM	EDIT	
01313	0	71	0	00006	787	LDX	LTR2,XO	RESTORE
01314	0	61	0	00005	788	MIN	LTR1	INCREMENT SEQUENCE
01315	0	76	0	00005	789	LDA	LTR1	
01316	0	61	0	00142	790	MIN	L6C	
01317	0	01	0	01215	791	BRU	END6	
01320	0	54	0	00157	792	PLT1 SUB	L6CP	
01321	0	35	0	00025	793	STA	CNTR	
01322	0	55	0	00025	794	ADD	CNTR	
01323	0	55	0	00025	795	ADD	CNTR	3 * SEQUENCE
01324	0	55	0	00116	796	ADD	P3	
01325	0	55	0	00134	797	ADD	TPL	
433 01326	0	35	0	00007	798	STA	LTR3	CORRECT POSITION
01327	2	76	0	00000	799	LDA	0,X2	
01330	1	77	1	00007	800	XMA	*LTR3	EXCHANGE LITERALS
01331	2	35	0	00000	801	STA	0,X2	
01332	0	61	0	00007	802	MIN	LTR3	
01333	2	76	0	00001	803	LDA	1,X2	
01334	1	77	1	00007	804	XMA	*LTR3	
01335	2	35	0	00001	805	STA	1,X2	
01336	0	61	0	00007	806	MIN	LTR3	
01337	2	76	0	00002	807	LDA	2,X2	
01340	1	77	1	00007	808	XMA	*LTR3	
01341	2	35	0	00002	809	STA	2,X2	
01342	0	01	0	01301	810	BRU	PLT2	
01343	0	76	0	00113	811	FREF LDA	P24	
01344	0	35	0	00026	812	STA	CNT1	NO. OF BITS LEFT
01345	0	76	0	00121	813	LDA	M5	
01346	0	35	0	00030	814	STA	CNT3	SET FIELD COUNT
01347	0	76	0	00145	815	LDA	WORD	
01350	0	35	0	00147	816	STA	WRD1	SAVE FORM FOR EDIT
01351	0	35	0	00146	817	STA	WRD2	
01352	0	76	0	00041	818	LDA	Z	

01353	0	35	0	00145	819		STA	WORD	0 TO DATA
01354	0	75	0	00066	820		LDB	BO	
* 01355	0	43	0	00000	821	FR4	BRM	FLDC	COUNT BITS IN FIELD
01356	0	01	0	01415	822		BRU	FR5	NO MORE FIELDS
01357	0	61	0	00030	823		MIN	CNT3	
01360	0	35	0	00027	824		STA	CNT2	FIELD SIZE
* 01361	1	72	0	00000	825		SKE	AB	ADDRESS BITS
01362	0	01	0	01370	826		BRU	FR2	NOT ADDRESS SIZE
01363	1	72	0	00026	827		SKE	CNT1	BITS LEFT
01364	0	01	0	01370	828		BRU	FR2	NOT ADDRESS FIELD
* 01365	0	43	0	00401	829		BRM	SCNL	
01366	0	36	0	00144	830		STB	WMOB	
01367	0	01	0	01374	831		BRU	FR3	
* 01370	0	43	0	01201	832	FR2	BRM	SCAN	GET NON-ADDRESS FIELD
01371	0	43	0	01432	833		BRM	SKE	
01372	0	00	0	00106	834		HLT	RELM	
01373	0	61	0	00021	835		MIN	RERR	SET R FLAG
01374	0	75	0	00041	836	FR3	LDB	Z	
01375	0	71	0	00027	837		LDX	CNT2,X0	
01376	2	6600	000		838		RSH	0,X2	LEFT ADJUST IN B
01377	1	72	0	00041	839		SKE	Z	
01400	0	01	0	01423	840		BRU	FR6	
01401	0	76	0	00041	841	FR1	LDA	Z	
01402	0	71	0	00026	842		LDX	CNT1,X0	
01403	2	6700	000		843		LSH	0,X2	
01404	0	16	0	00145	844		MRG	WORD	INSERT FIELD IN WORD
01405	0	35	0	00145	845		STA	WORD	
01406	0	76	0	00026	846		LDA	CNT1	
01407	0	54	0	00027	847		SUB	CNT2	DECREMENT BITS LEFT
01410	0	35	0	00026	848		STA	CNT1	
01411	0	76	0	00150	849		LDA	TERM	
01412	1	72	0	00061	850		SKE	CCHR	TEST FOR COMMA
01413	0	01	0	01415	851		BRU	FR5	END OF REFERENCE
01414	0	01	0	01355	852		BRU	FR4	PROCESS NEXT FIELD
01415	0	76	0	00147	853	FR5	LDA	WRD1	
01416	0	35	0	00146	854		STA	WRD2	SET FORM FOR PRINTING
01417	0	76	0	00066	855		LDA	BO	
01420	0	53	0	00030	856		SKN	CNT3	
01421	0	35	0	00146	857		STA	WRD2	TJO MANY FIELDS TO EDIT

01422	0 01 0 00425	858	BRU	LIN8
01423	1 72 0 00117	859	FR6 SKE	M1
01424	0 61 0 00022	860	MIN	TERR
01425	0 43 0 01432	861	BRM	SKB
01426	0 00 0 00066	862	HLT	BO
01427	0 53 0 00117	863	SKN	M1
01430	0 61 0 00022	864	MIN	TERR
01431	0 01 0 01401	865	BRU	FR1
01432	0 00 0 00000	866	\$SKB HLT	
01433	1 77 0 01432	867	XMA	SKB
01434	0 55 0 01444	868	ADD	IND1
01435	1 77 0 01432	869	XMA	SKB
01436	0 46 00014	870	XAB	
01437	0 72 1 01432	871	SKA	*SKB
01440	0 01 0 01442	872	BRU	\$+2
01441	0 61 0 01432	873	MIN	SKB
01442	0 46 00014	874	XAB	
01443	0 51 0 01432	875	BRR	SKB
01444	0 00 1 00001	876	IND1 HLT	*1
		877	\$M1,LINE,90,P14,BCIF,SPAC,TEXT1,M23	
		878	\$IERR,INR1,DLBL,FRM4,XFLG,OPD1	
		879	\$B11,C3	
		880	END	
01445	00177750			
01446	07700000			
01447	00040000			
01450	00077777			
01451	00000073			
01452	00007777			
01453	00002140			
01454	00000036			
01455	00000067			
01456	01010101			
01457	00177774			
01460	00002040			
01461	00177770			
01462	00006060			
00056			MT	
00057			MTE	

4-35

00221	SCNX
00223	SCIX
00225	L0P
00227	LITM
00235	ML0C
00236	ALN
00730	SCALE
00256	EDCT
00257	READ
00307	FLD
00524	SYM
01175	CHR
01032	GET
00300	SM1
00301	LSYM
00553	SRCH
00304	POPI
00651	NSRT
00343	POPR
00576	FORCE0
01365	SCNL
00356	NAB
00361	ADDR
00451	E0D
00372	E0M
00405	INDB
01370	SCAN
00415	XMSK
00423	INST
01312	EDIT
01210	PRNT
00460	SKSE0D
00462	E0DI
00521	CTT
01166	DLY1
01205	EDTV
00654	EDE
01272	H0ME
01217	MAXL

01253	EETL
00731	DPW
00732	DPWR
00772	DECW
01056	ENDSI
01064	ERRC
01071	DWC
01271	OUTP
01170	CEUF
01241	EREF1
01246	EREF2
01273	WE0F
01355	FLDC
01361	AP

**SDS PROGRAM LIBRARY
PROGRAM DESCRIPTION**

Page 1 of 9

Catalog No. 012009

IDENTIFICATION: 900 Series SYMBOL Part II

AUTHOR: SDS

ACCEPTED: January 15, 1965

COMPUTER
CONFIGURATION: Any SDS 900 series computer with at least 4K memory.

PURPOSE: Perform search, insert and scan (and evaluate) the operand field of a SYMBOL line.

PROGRAMMED
OPERATORS: CAB, CBA, CAX, CXA, CBX, CNA, SKE, SKR, MUL, DIV, ADM, XMA

STORAGE: 02103 locations including constants

TIMING: N/A

USE: SYMBOL consists of three parts (separately assembled programs) plus a mnemonic table plus I/O subroutines.

Part II performs the table manipulative functions (search, insert and move) for the four item tables: mnemonics, symbols, references and literals. In addition, Part II scans and evaluates operand field expressions.

Subroutines:

The following subroutines are documented in the order of their appearance within SYMBOL Part II.

CNVRT	GNF	SCI
DECW	MAXL	SCNL
DPA	MOVE	SCNM
DPMT	NSRT	SCNR
DPNM	OCTW	SRCH
DPSS	SCAN	SSIGN
DPW	SCC	SYM

USE: (Cont)

SCNL Scan literal

BRM SCNL with same conditions as
SCAN

return with same conditions as SCAN

Scans address field. Will accept literal or
reference as result. Uses SCAN, SCNM, SCNR
and GET subroutines.

SCNM Insert literal

BRM SCNM with literal in A, B

return with address of literal in A if pass
two

If pass two and literal is not in table, the literal
will be inserted. Uses SRCH subroutine and
uses MOVE if literal has to be inserted.

SCNR Scan reference

BRM SCNR with same conditions as
SCAN

return with same condition as SCAN

If pass two, and address consisted of one symbol
which was not found (VERR contains non-zero)
and no connectors were present (CHR1 contains
zero), address is considered to be an external
reference. If reference was not previously in
table, it will be inserted. Uses SCAN and if
reference uses SRCH and if new reference,
uses MOVE.

SCAN Evaluates symbolic expression

BRM SCAN with first character of
expression in CHR return with value of
expression in A and in VALU and mode of
expression in B and in MODE.

USE: (Cont)

Upon exit from SCAN, the character following the character which terminated the expression will be in CHR. The character which terminated the expression will be in TERM.

The SCAN routine uses the subroutines:

SCI unless first character of expressor
terminates expression

SCC unless first character of expressor
terminates expression

If a connector (other than a terminator) was encountered, CHR1 will be nonzero.

SCI Evaluates an item

BRM SCI with first character of item
in X2

return with value of item in A, mode of
item in B

Upon exit from SCI, the first character following the item is in CHR.

The SCI routines uses the following subroutines:

GET
TCHR
CNVRT if the item is octal or decimal
SRCH if the item is symbolic
SCAN if the item is subexpression

SCC Evaluates a connector

BRM SCC with first character of
connector in X2

return with code for connector in A (MODE
is merged to A)

USE: (Cont)

Upon exit the first character following connector is in CHR. SCC uses the GET subroutine.

The following code is used for connectors:

<u>Operations</u>	<u>Terminators</u>
10 ++	00 Δ
11 --	01 ,
22 **	02)
33 +	
34 -	
45 *	
46 /	
47 //	
50 *+	
51 */	

SYM Collects a symbol

BRM SYM with first character of symbol in CHR

return with first word of symbol in SM1 and A, second word of symbol in SM2 and B

Upon exit from SYM, the character following the symbol is in CHR. Sym uses the TCHR subroutines.

SRCH Search table for item

BRM SRCH with location if key in A, location of table packet

(see MOVE subroutine description) in B

return if no match is found

return if found

USE: (Cont)

If item is found the location of the item is in X2, the second word of the item is in B and the third word of the item is in A. If item is not found the location of the item with the largest key less than the key given is in X2.

NSRT Insert label subroutine

NSRT is used to insert an item in the mnemonic table (for FORM and OPD labels), the symbol table, the reference table, or the literal table. First the item is searched for and one of the following is done:

1. If pass 1 and the item was not found, the item is inserted by using the MOVE subroutine.
2. If pass 1 and the item was found and is not identical to the item to be inserted, the duplicate flag is set and the new item is discarded.
3. If pass 2 and the item was not found, there was a program or machine error.
4. If pass 2 and the item was found, the duplicate flag is checked and if set, the duplicate error is set.

NSRT is entered with the location of the item in A and the location of the table packet (see MOVE subroutine description) in B. The SRCH and MOVE subroutines are used.

Calling sequence is:

```
BRM  NSRT  with A and B as specified  
return
```

USE: (Cont)

MOVE Move item into table subroutine

Tables are described by a six-word packet as follows:

Packet Origin	B	Base of table = location of first item in table minus 3.
+1	F	Location of first item to be compared when doing binary search.
+2	m	Initial increment for binary search.
+3	M	Mask for masking second word when searching.
+4	n	If there are k entries in the table, $n = 3k - m$.
+5	T	Type + 0 if table expands up, -1 if table expands down.

If there are k entries in the table:

$$m = 3 * 2^{\lceil \log_2 k \rceil}$$

$$n = 3 * k - m$$

$$F = B + n + 3$$

There is a packet for each table, specifically:

TPM	Mnemonic command table packet (up from S5)
TPS	Symbol table packed (down from end of memory)
TPR	Reference table packet (down from end of symbol table)
TPL	Literal table packet (up from end of mnemonic command table)

USE: (Cont)

All items are three words. MOVE is entered with the location of the item to be inserted in LKI, the location of the packet for the table in which to insert in LKT and the location of the item which is to precede the item being inserted in X. MOVE will move part of the table up or down (depending on T), insert the item, and modify the packet as required.

Calling sequence is:

BRM MOVE with X as specified

return

CNVRT Convert 4 characters

BRM CNVRT with 4 six bit characters
in A

return with binary integer in A

The conversion will be from decimal if X2 contains 0, and from octal if X2 contains 3.

SSIGN Set sign

BRM SSIGN with possible sign character
in CHR

return

If CHR contains a minus sign, SIGN will be set to -1. Otherwise, SIGN will contain zero. If contents of CHR was "+" or "-", this character will be skipped. Uses GET subroutine if CHR contains "+" or "-".

DPMT Double precision multiply by ten

BRM DPMT with multiplicand in A, B

return with product in A, B

USE: (Cont)

DPA Double precision add

BRM DPA with addend in A, B and original in WRD1, WRD2

return with sum in A, B

DPNM Double precision normalized multiply

BRM DPNM with multiplicand in WRD1, WRD2 and multiplier in MULT1, MULT2

return with product in A, B and WRD1, WRD2

Operands must be normalized and result will be normalized. DPNM uses the DPA subroutine.

DPW Double precision word

BRM DPW with first character of constant in CHR

return with result in A, B and in WRD1, WRD2

This subroutine computes a fixed or floating constant. The contents of SCALE determine the implied binary scaling (in case of no B or */). Upon exit from DPW, the character which terminated the constant is in TERM, and the next character is in CHR. Subroutines used are GET, SCI, TCHR, DPA, SSIGN, DPMT, SPNM, GNF, DPSS.

DPSS Double precision set sign

BRM DPSS with argument in A, B

return with result in A, B

If the contents of DPSIGN is negative, this subroutine puts the negative of the argument in A, B.

USE: (Cont)

OCTW Evaluates an octal item

BRM OCTW with first character in CHR

return with value in VALU

Upon exit the character following the item is in CHR. OCTW uses the GET, SSIGN, GNF, and TCHR subroutines.

DECW Evaluates a decimal item

BRM DECW with first character in CHR

return with value in VALU

Upon exit the character following the item is in CHR. DECW uses the SSIGN and TCHR subroutines.

GNF Get next field

BRM GNF

return with blank or comma in CHR

This subroutine will skip characters until a blank or comma is encountered. If the initial contents of CHR is not a blank or comma, the E error flag will be set.

MAXL Compute maximum location counter value

BRM MAXL

return

If the contents of LOC is greater than the contents of MLOC, the contents of LOC replaces the contents of MLOC.

900 SERIES SYMBOL PART II

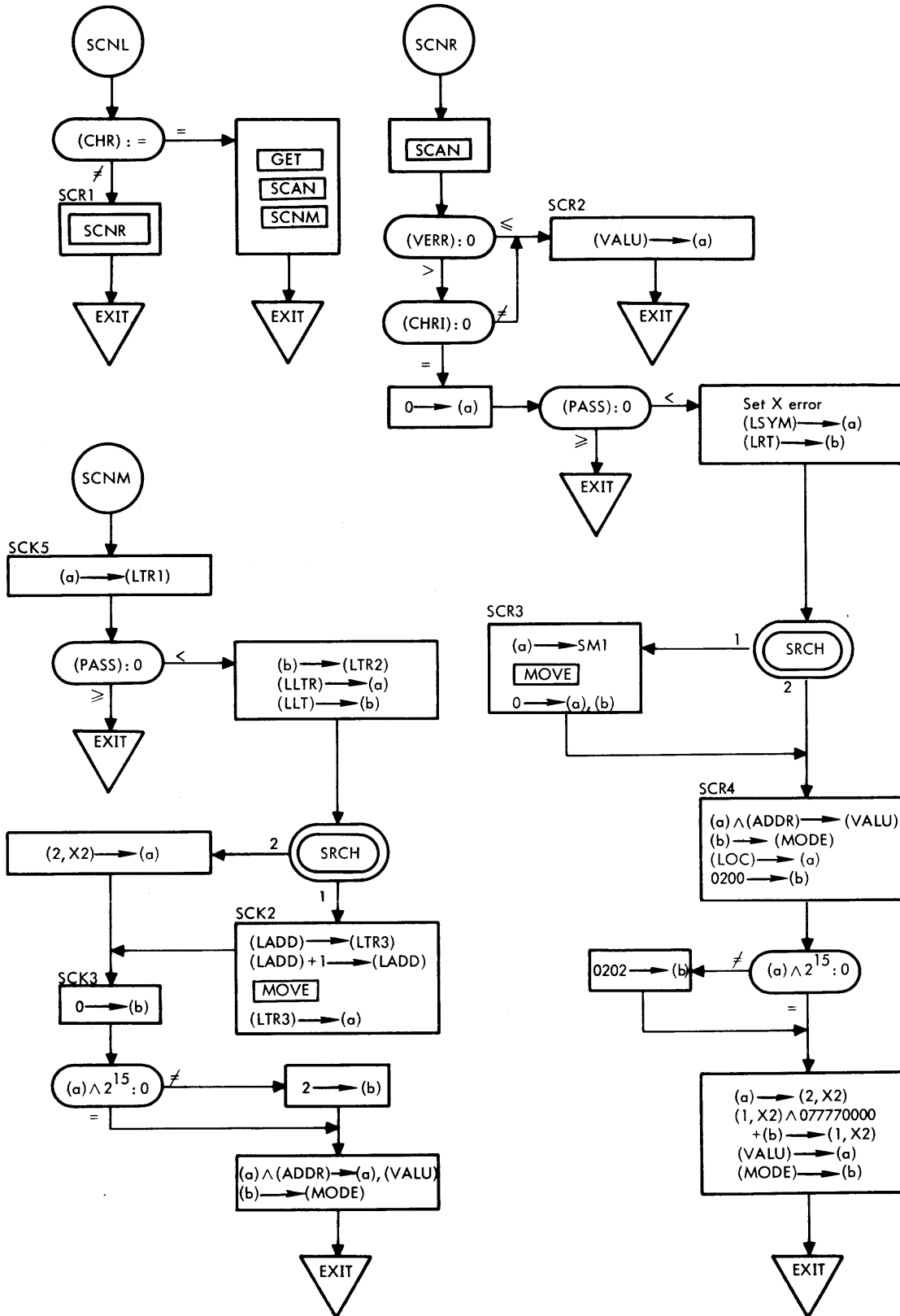

900 SERIES SYMBOL PART II (cont.)

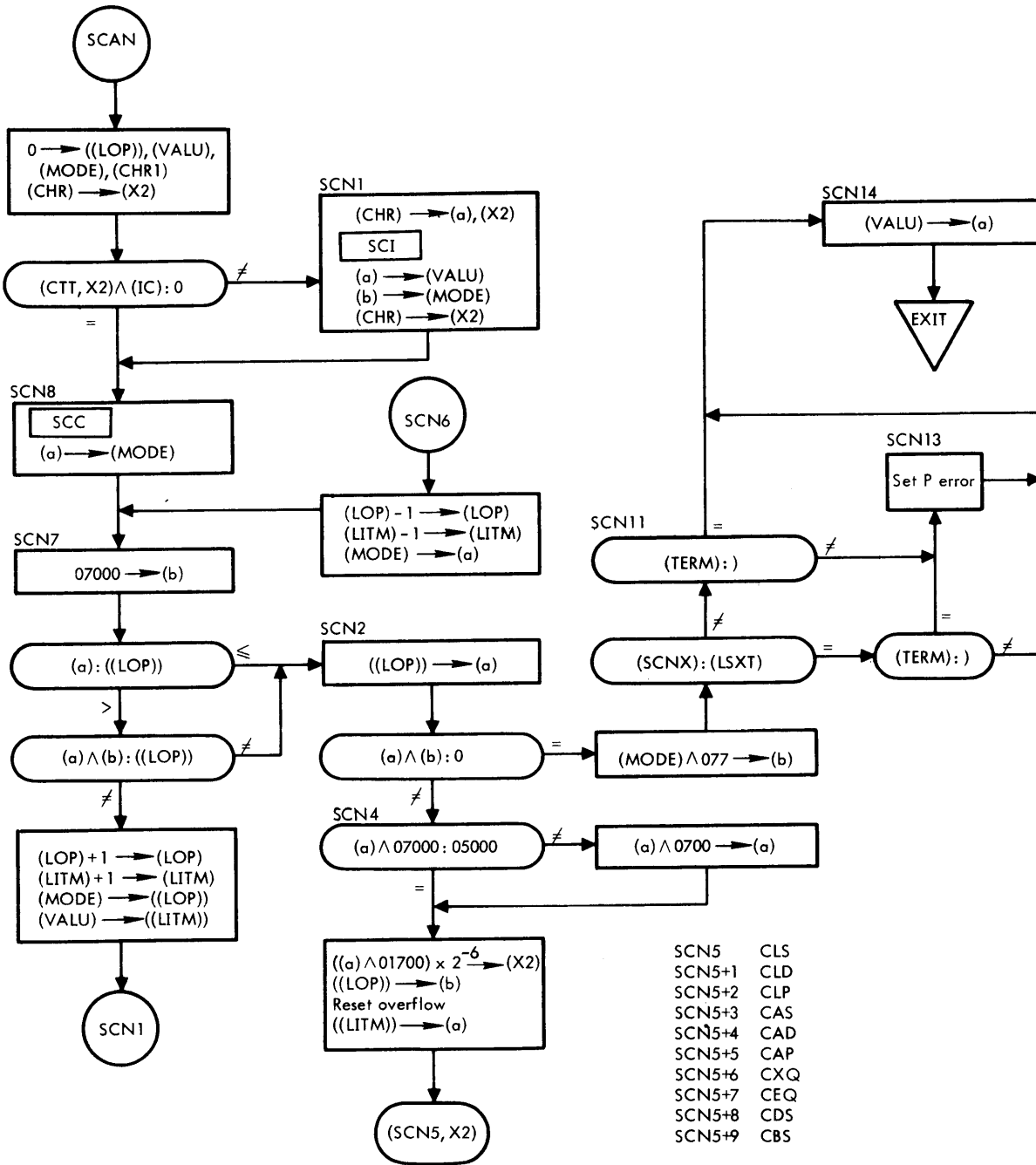

900 SERIES SYMBOL PART II (cont.)

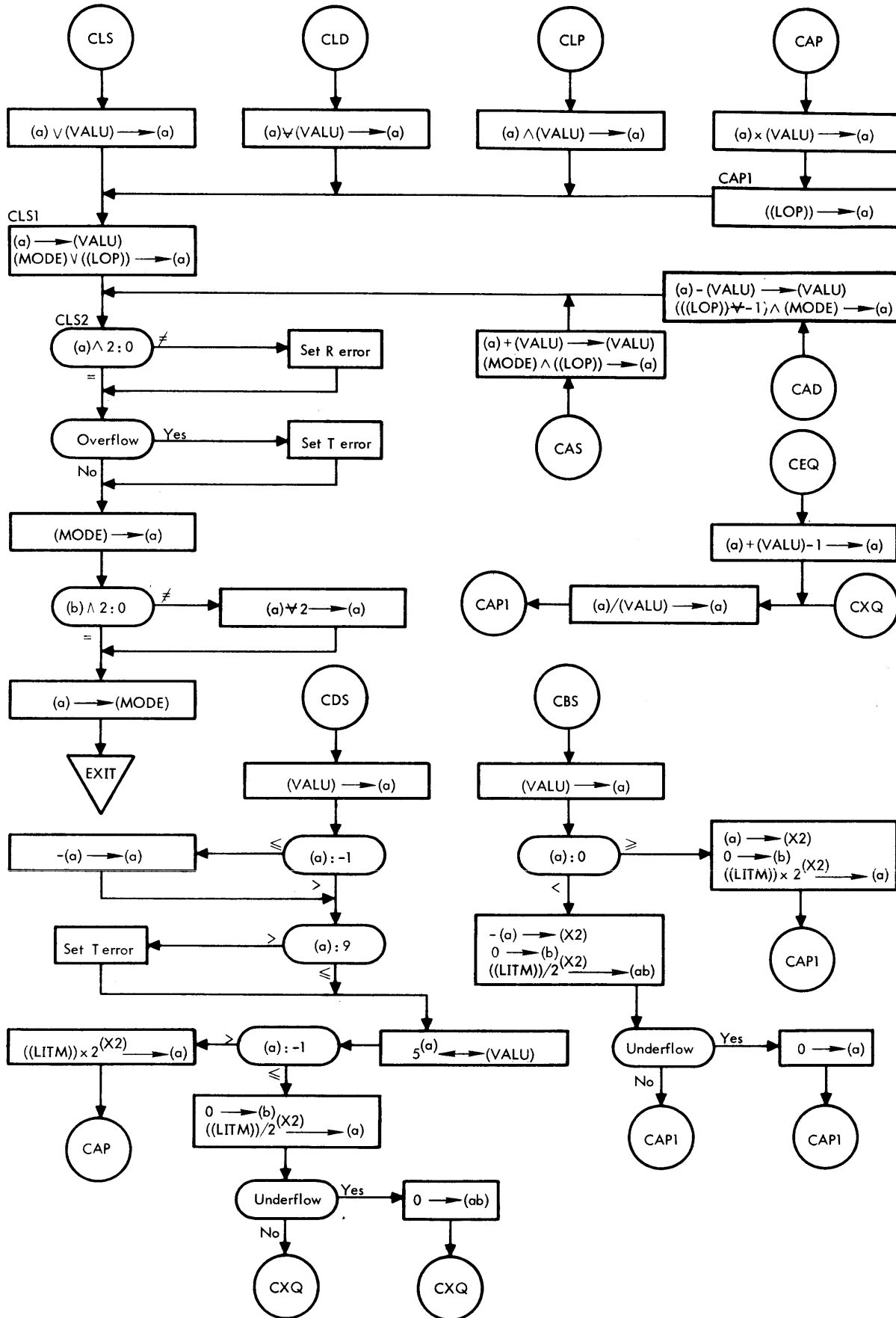

900 SERIES SYMBOL PART II (cont.)

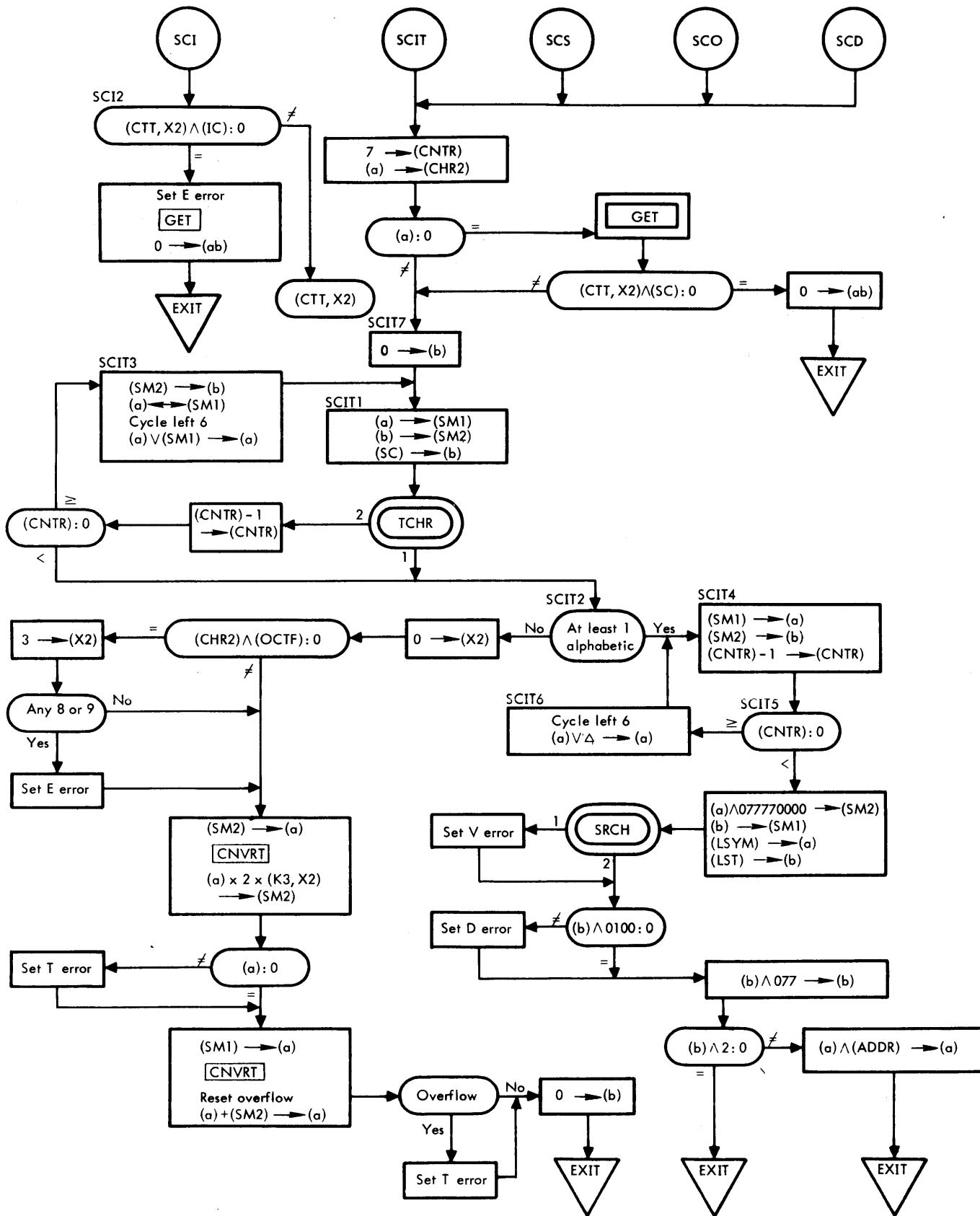

900 SERIES SYMBOL PART II (cont.)

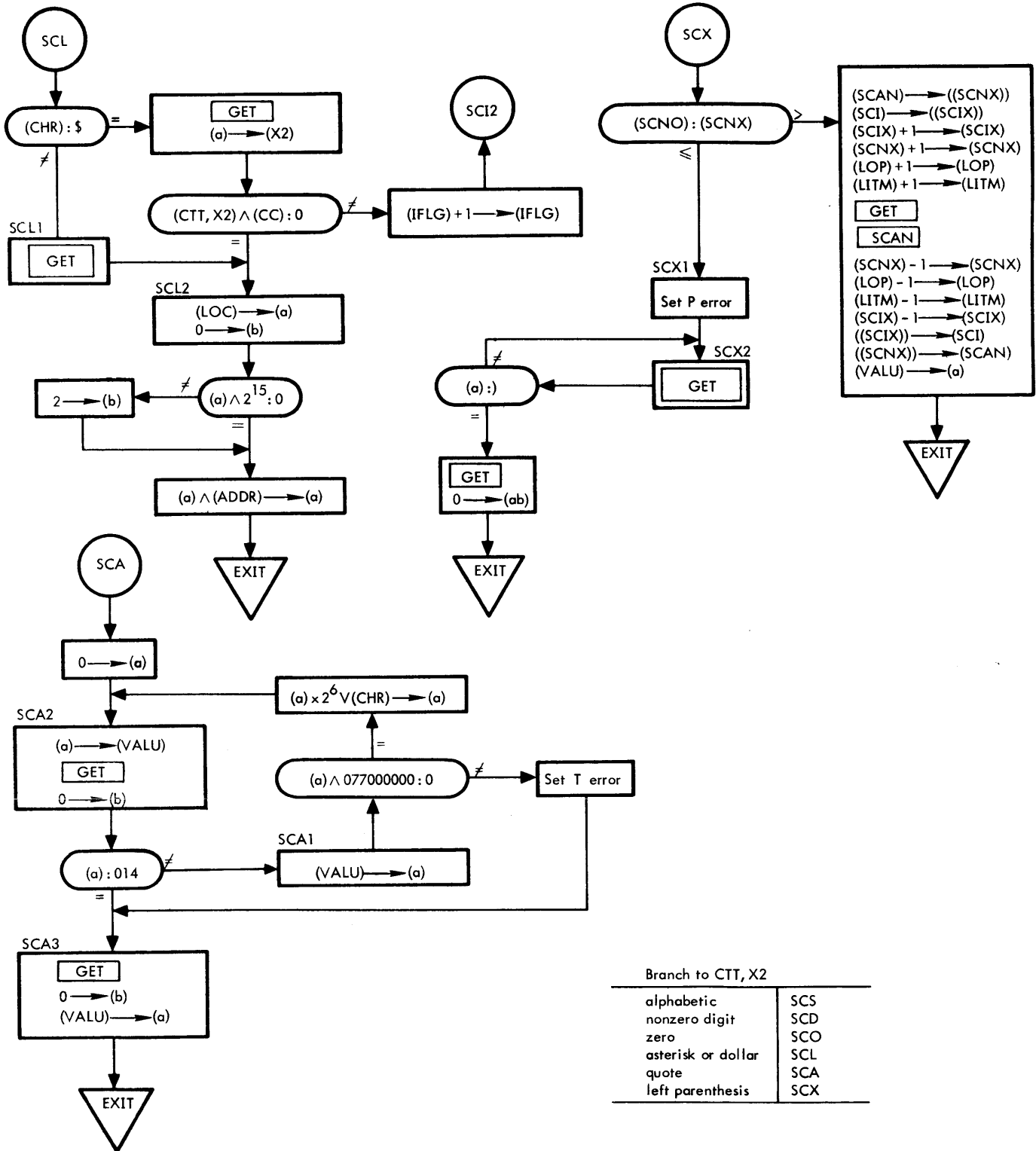

900 SERIES SYMBOL PART II (cont.)

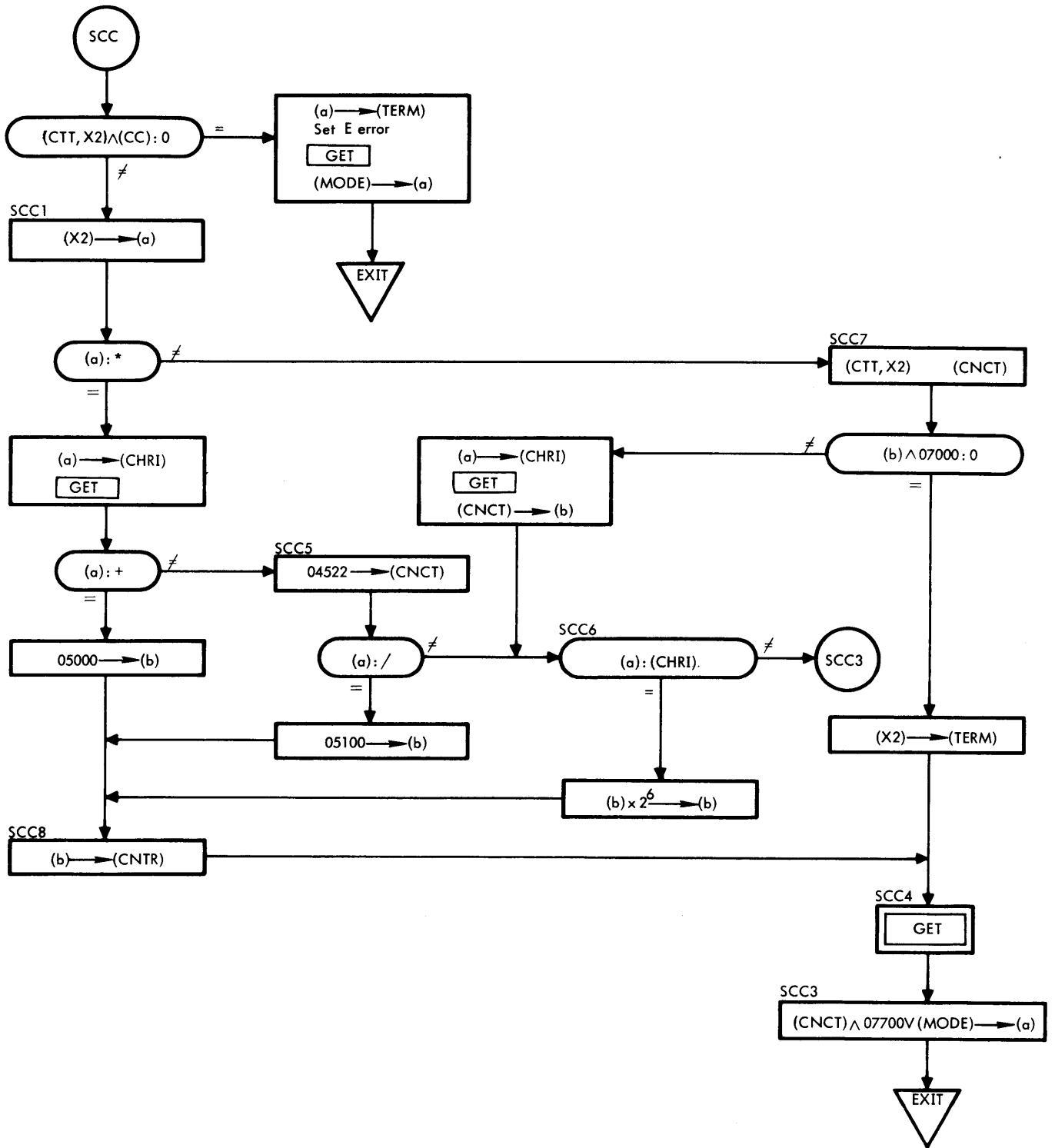

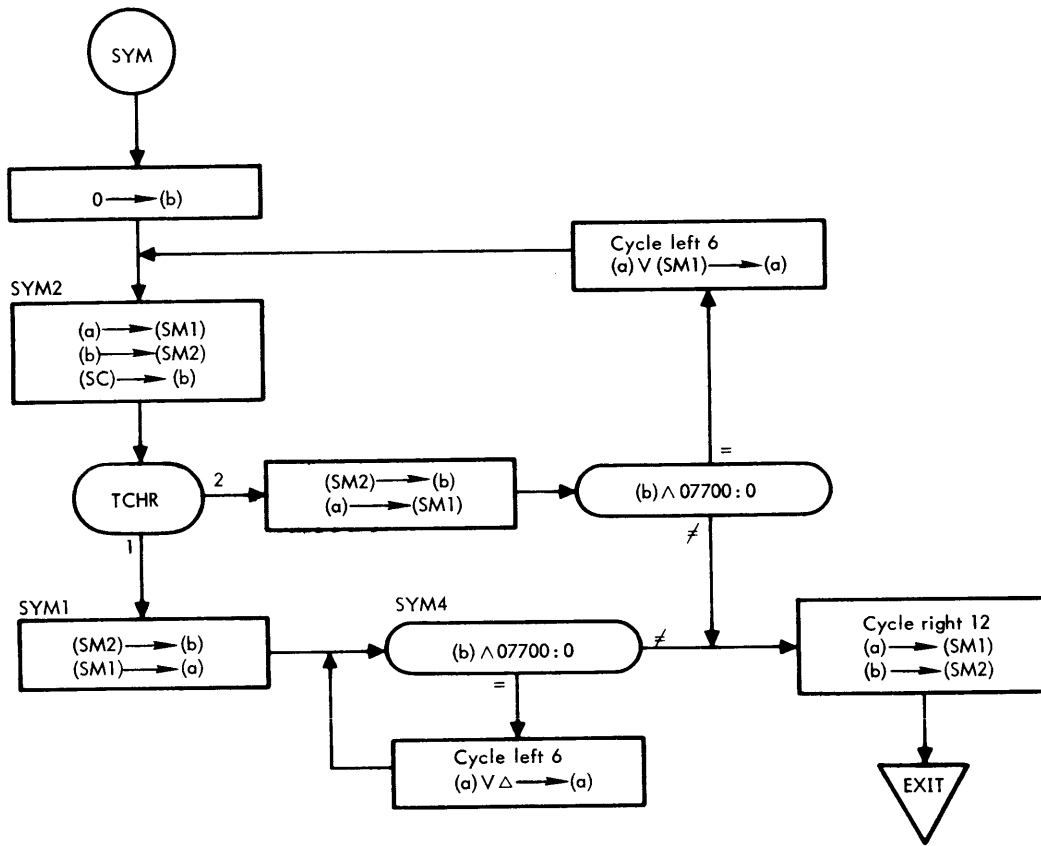

900 SERIES SYMBOL PART II (cont.)

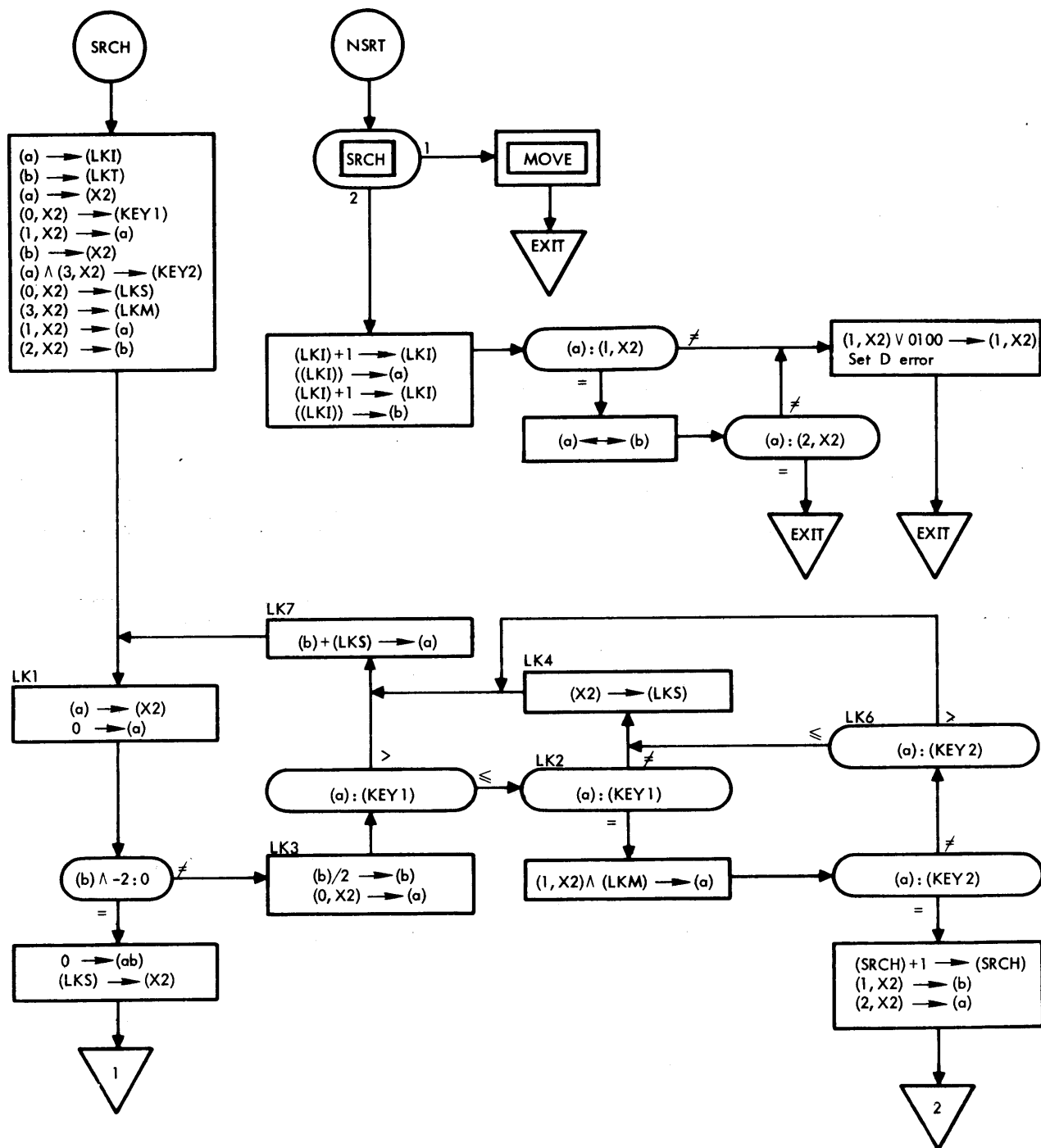

900 SERIES SYMBOL PART II (cont.)

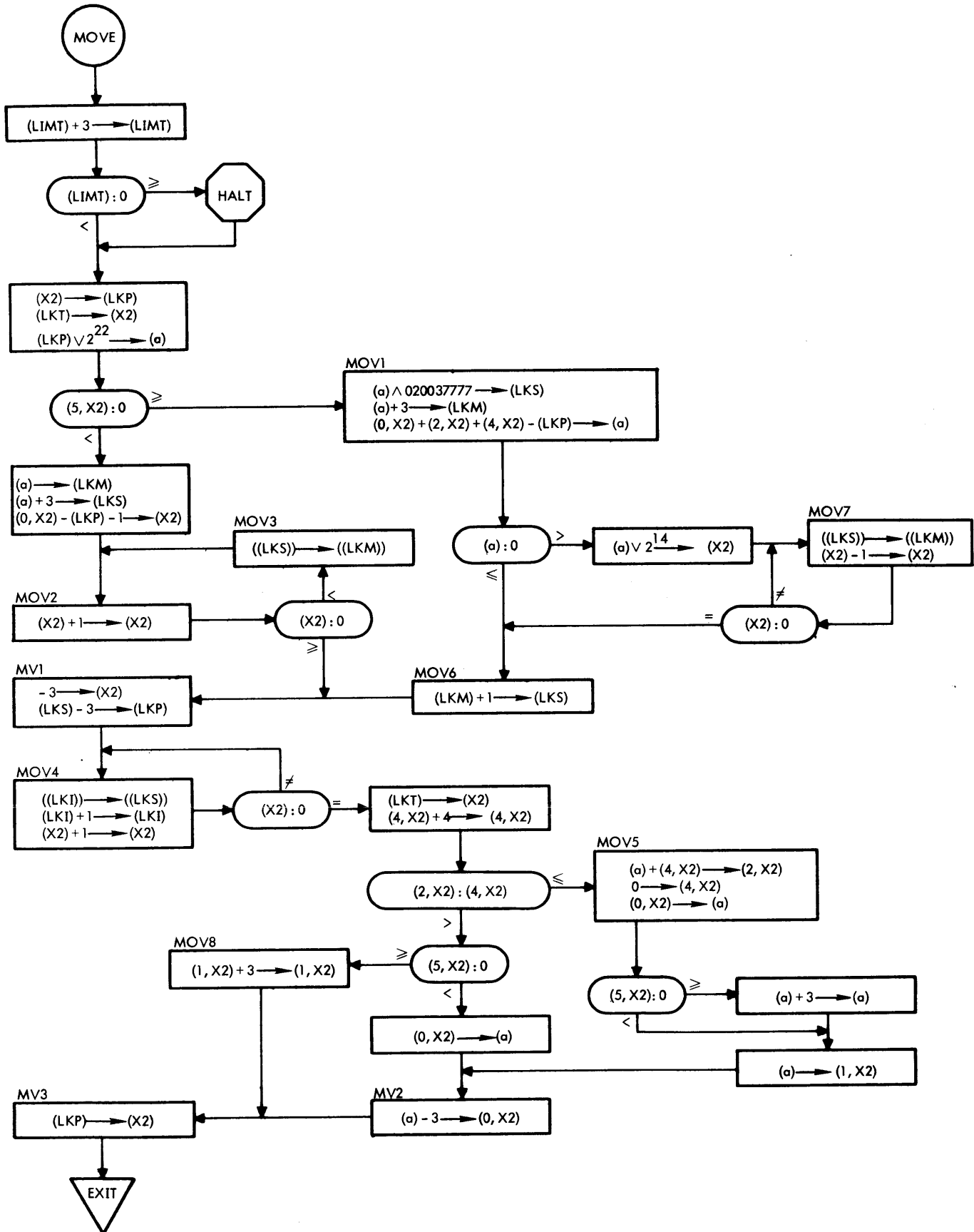

900 SERIES SYMBOL PART II (cont.)

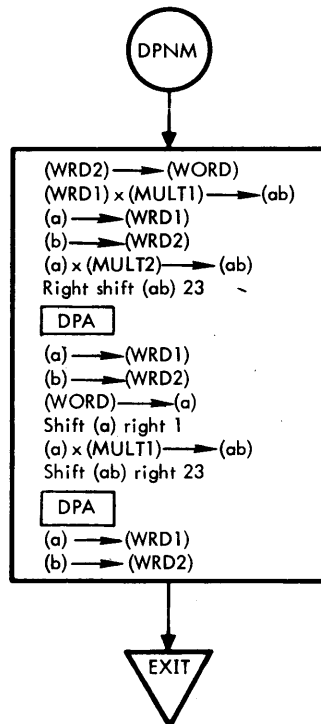
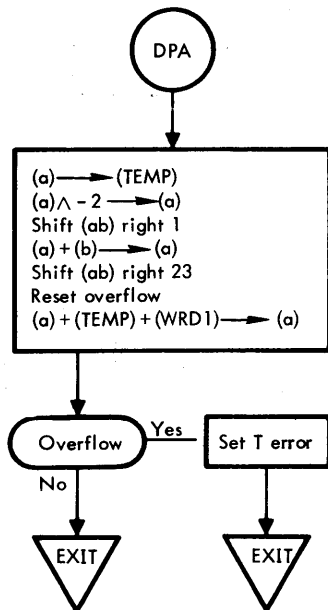
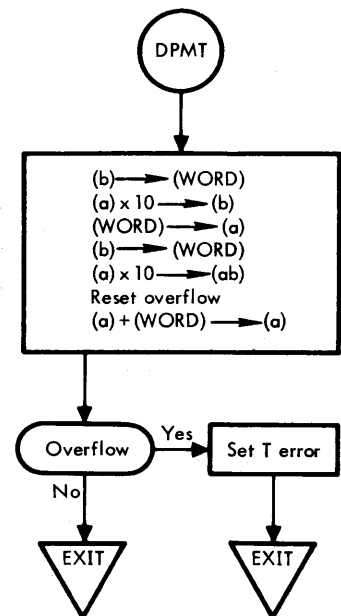
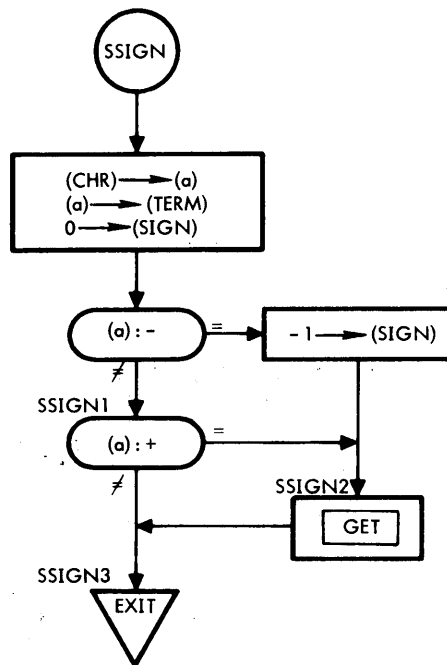
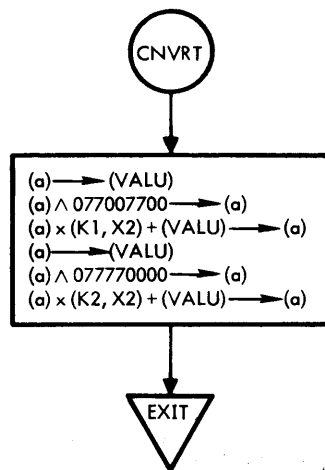

900 SERIES SYMBOL PART II (cont.)

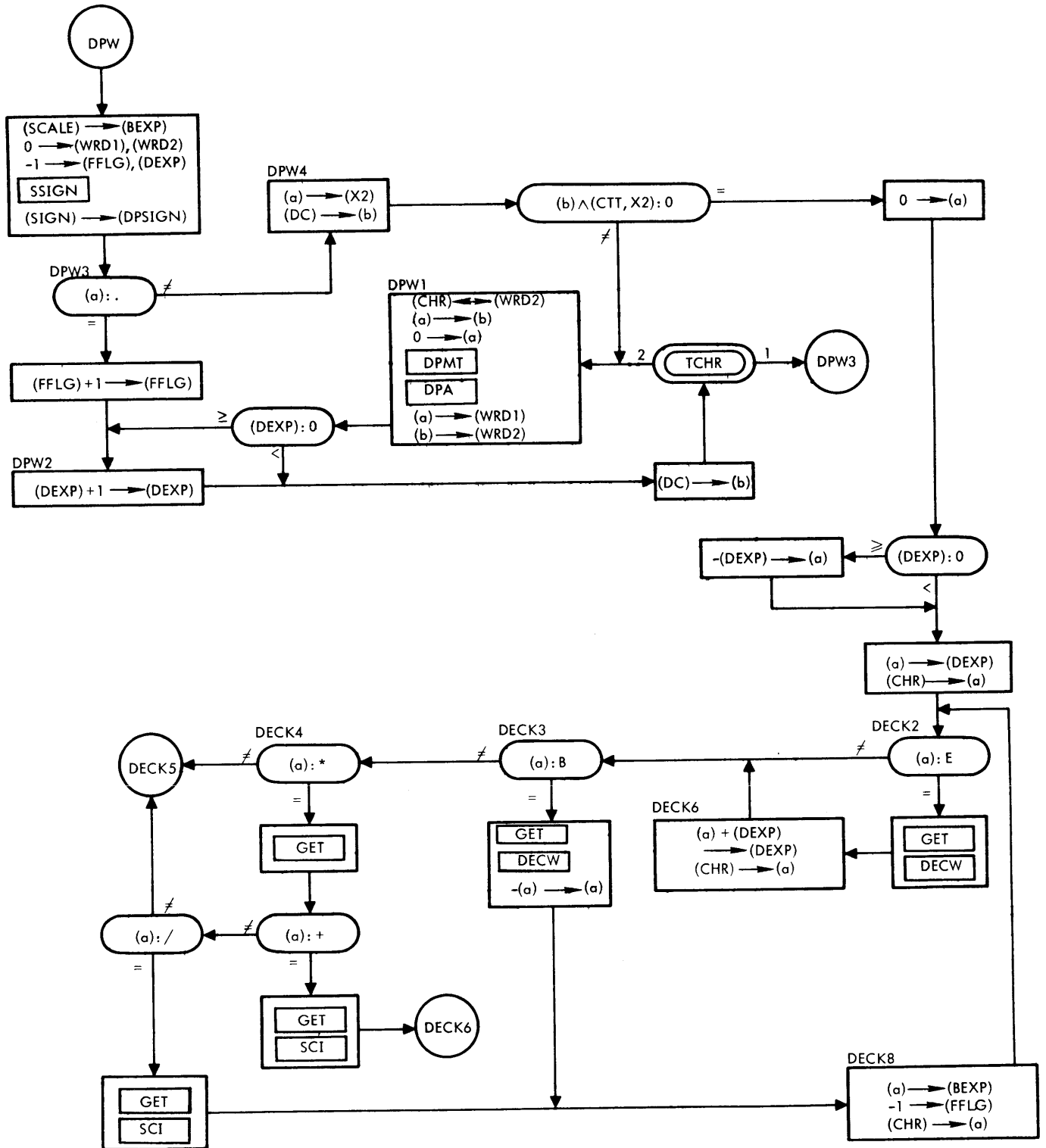

900 SERIES SYMBOL PART II (cont.)

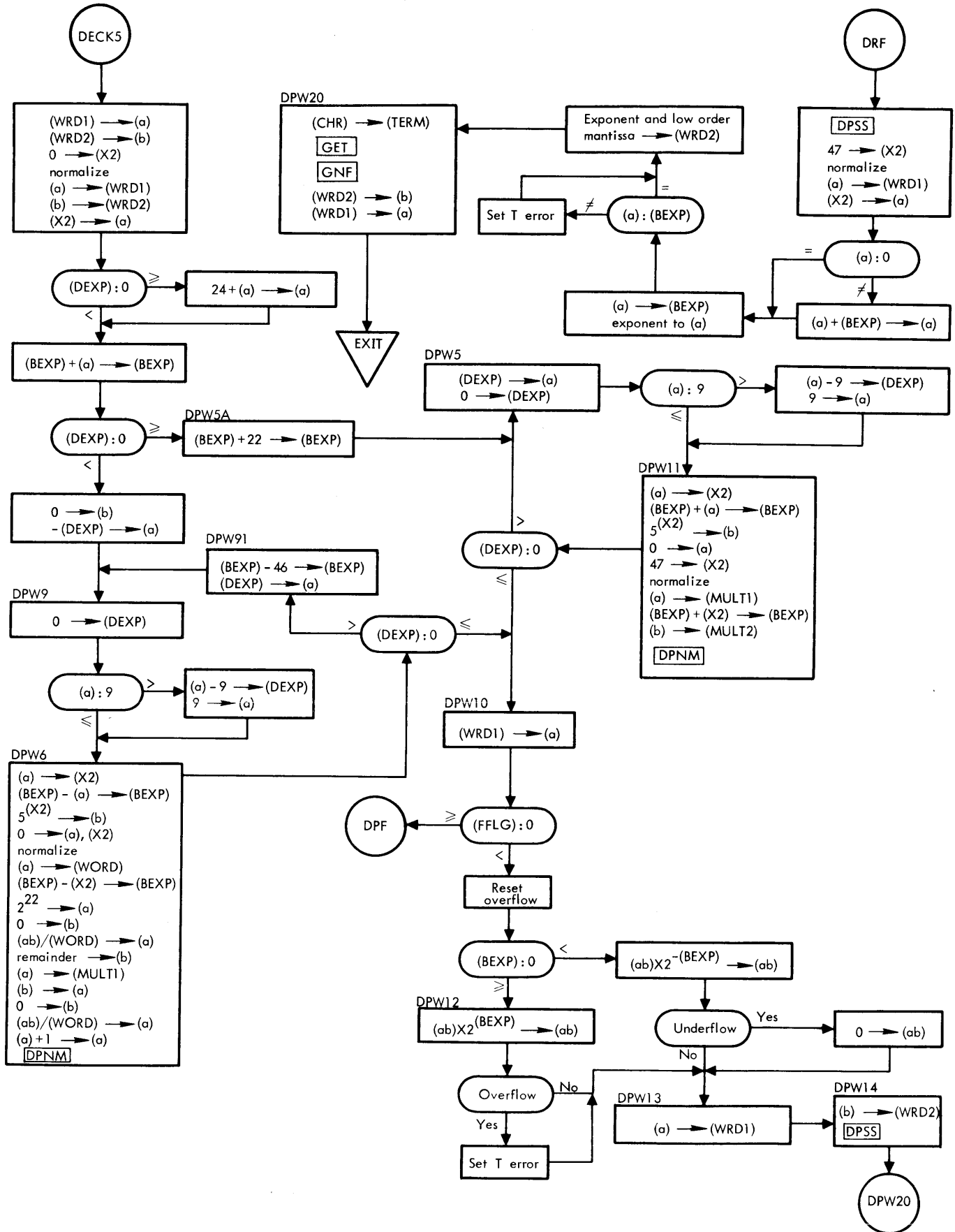

900 SERIES SYMBOL PART II (cont.)

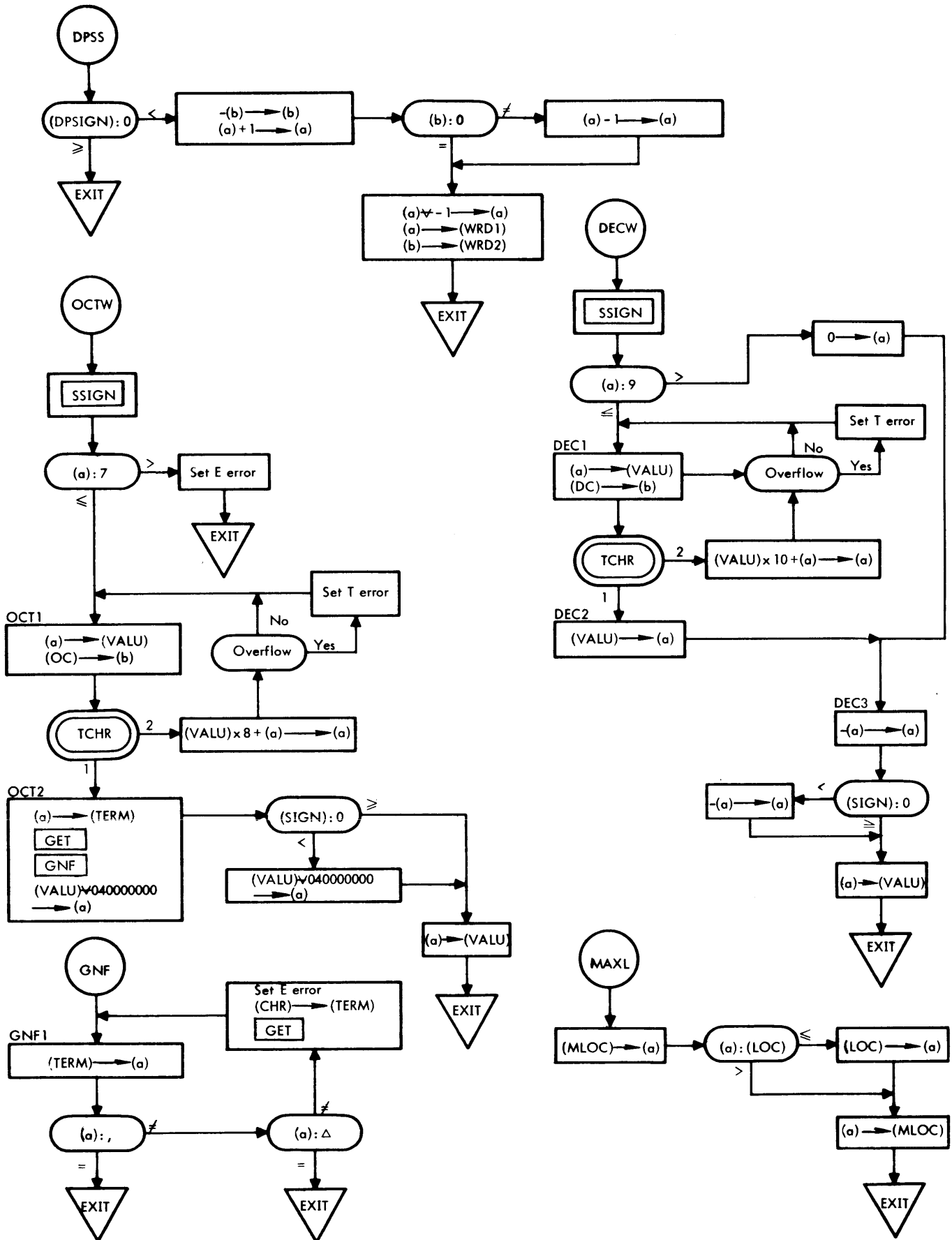

	00000000	1 *	S2	
	00000000	2 S9300	EQU	0
	00000002	3 X0	EQU	S9300
		4 X2	EQU	2-S9300
		5 CAB	ØPD	016400000
		6 CBA	ØPD	016500000
		7 CAX	ØPD	016600000
		8 CXA	ØPD	016700000
		9 CBX	ØPD	017000000
		10 CNA	ØPD	017100000
		11 SKE	ØPD	017200000
		12 SKR	ØPD	017300000
		13 MUL	ØPD	017400000
		14 DIV	ØPD	017500000
		15 ADM	ØPD	017600000
		16 XMA	ØPD	017700000
00000	0 00 0 00035	17 \$LSYM	HLT	SM1
00001		18 \$MLØC	RES	1
00002		19 \$SCNX	RES	1
00003		20 \$LØP	RES	1
00004		21 \$LITM	RES	1
00005		22 \$SCIX	RES	1
00006	23305101	23 CHR1	TEXT	4,CHR1
00007	23305102	24 CHR2	TEXT	4,CHR2
00010		25 LREF	RES	1
00011	23452363	26 CNCT	TEXT	4,CNCT
00012		27 TEMP	RES	2
00014	0 00 0 00000	28 LLT	HLT	TPL
00015	0 00 0 00000	29 LLTR	HLT	LTR1
00016	0 00 0 00000	30 SCNØ	HLT	SØT
00017		31 B1	RES	0
00017	20000000	32 B1	DATA	020000000
00020	70000000	33 A0	DATA	070000000
00021	00007000	34 A4	DATA	07000
00022	00000700	35 A5	DATA	0700
00023	00040000	36 B9	DATA	040000
00024	77000000	37 C0	DATA	077000000
00025	00007700	38 C2	DATA	07700

LOCATION OF LITERAL TABLE PACKET
 LOCATION OF LTR1
 SCAN STORAGE LIMIT

5-23

*
*
*

00026	77007700	39	CO2	DATA	077007700
00027	00000105	40	P69	DATA	69
00030	00000057	41	P47	DATA	47
00031	00000011	42	P9	DATA	011
00032	00000005	43	P5	DATA	5
00033	00000202	44	RRM	DATA	0202
00034	2 00 0 37777	45	XADR	HLT	-1,X2
00035		46	\$SM1	RES	1
00036	62440260	47	SM2	TEXT	4,SM2
00037	62440360	48	SM3	TEXT	4,SM3
00040	42257001	49	KEY1	TEXT	4,KEY1
00041	42257002	50	KEY2	TEXT	4,KEY2
00042	43423160	51	LKI	TEXT	4,LKI
00043	43424460	52	LKM	TEXT	4,LKM
00044	43424760	53	LKP	TEXT	4,LKP
00045	43426260	54	LKS	TEXT	4,LKS
00046	43426360	55	LKT	TEXT	4,LKT
00047		56	SIGN	RES	1
00050		57	DPSIGN	RES	1
00051		58	BEXP	RES	1
00052		59	\$SCALE	RES	1
00053		60	DEXP	RES	1
00054		61	FFLG	RES	1
00055		62	MULT1	RES	1
00056		63	MULT2	RES	1
00057	0 00 0 04522	64	AP	HLT	PC6N
		65	KF1	FORM	7,17
		66	KF2	FORM	13,11
00060	112 000000	67	K1	KF1	10-0100,0
00061	10144 0000	68	K2	KF2	100-010000,0
00062	00011610	69	K3	DATA	5000
00063	110 000000	70		KF1	010-0100,0
00064	10100 0000	71		KF2	0100-010000,0
00065	00004000	72		DATA	010000/2
00066		73	B23	RES	0
00066		74	ONE	RES	0
00066	00000001	75	FIVES	DATA	1
00067	00000005	76		DATA	5
00070	00000031	77		DATA	25

PRODUCT CONNECTER

00071 00000175
00072 00001161
00073 00006065
00074 00036411
00075 00230455
00076 01372741
00077 07346545
00100
00100 77777776
00101 00000777
00102 77777000
00103 00007777
00104 00770077
00105 07070707

5-25
00106
00106 0 47 0 00443
00107 0 47 0 00443
00110 0 47 0 00443
00111 0 47 0 00443
00112 0 47 0 00443
00113 0 47 0 00443
00114 0 47 0 00443
00115 0 47 0 00443
00116 0 46 0 00443
00117 0 46 0 00443
00120 0 00 0 00000
00121 0 00 0 00077
00122 0 40 0 00577
00123 40000000
00124 0 00 0 00002
00125 0 00 0 00030
00126 0 20 0 03310
00127 0 54 0 00443

78 DATA 125
79 DATA 625
80 DATA 3125
81 DATA 15625
82 DATA 78125
83 DATA 390625
84 DATA 1953125
85 M2 RES 0
86 L0M DATA 07777776
87 FEM DATA 0777
88 FMM DATA 077777000
89 MK12 DATA 07777
90 MK6 DATA 0770077
91 MK3 DATA 07070707
92 XYZ 0PD 06000000
93 ITM 0PD 04000000
94 C0N 0PD 02000000
95 STM 0PD 05400000
96 DTM 0PD 04600000
97 0TM 0PD 04700000
98 S0TT RES 0
99 0TM SCD
100 0TM SCD
101 0TM SCD
102 0TM SCD
103 0TM SCD
104 0TM SCD
105 0TM SCD
106 0TM SCD
107 DTM SCD
108 DTM SCD
109 Z HLT 0
110 C3 HLT 077
111 ITM SCA
112 B0 DATA 040000000
113 B22 HLT 2
114 P24 HLT 24
115 C0N SC0N
116 STM SCS

ITEM
CONNECTER
SYMBOL,LABEL,ITEM
DECIMAL,SYMBOL,ITEM
OCTAL,DECIMAL,SYMBOL,ITEM

0 00
1 01
2 02
3 03
4 04
5 05
6 06
7 07
8 10
9 11

• 14

+ 20
A 21

00130	0 54 0 00443	117	STM	SCS	B 22
00131	0 54 0 00443	118	STM	SCS	C 23
00132	0 54 0 00443	119	STM	SCS	D 24
00133	0 54 0 00443	120	STM	SCS	E 25
00134	0 54 0 00443	121	STM	SCS	F 26
00135	0 54 0 00443	122	STM	SCS	G 27
00136	0 54 0 00443	123	STM	SCS	H 30
00137	0 54 0 00443	124	STM	SCS	I 31
00140	0 00 0 00013	125	ECHR	HLT	'='
00141	0 00 0 00040	126	MCHR	HLT	'-'
00142	0 20 0 00200	127		CON	RCON
00143	0 00 0 00007	128	A7	HLT	7
00144	0 00 0 00003	129	P3	HLT	3
00145	0 00 0 00100	130	B17	HLT	0100
00146	0 20 0 03411	131		CON	DCON
00147	0 54 0 00443	132		STM	SCS
00150	0 54 0 00443	133		STM	SCS
00151	0 54 0 00443	134		STM	SCS
00152	0 54 0 00443	135		STM	SCS
00153	0 54 0 00443	136		STM	SCS
00154	0 54 0 00443	137		STM	SCS
00155	0 54 0 00443	138		STM	SCS
00156	0 54 0 00443	139		STM	SCS
00157	0 54 0 00443	140		STM	SCS
00160	0 00 0 00020	141	PLUS	HLT	'+'
00161	0 40 0 00555	142		ITM	SCL
00162	0 60 0 00555	143		XYZ	SCL
00163	0 00 0 00033	144	PCHR	HLT	'.'
00164	0 00 0 00014	145	QCHR	HLT	014
00165	0 00 0 00034	146	RCHR	HLT	'.)'
00166	0 20 0 00000	147		CON	BCON
00167	0 20 0 04647	148		CON	QCON
00170	0 54 0 00443	149		STM	SCS
00171	0 54 0 00443	150		STM	SCS
00172	0 54 0 00443	151		STM	SCS
00173	0 54 0 00443	152		STM	SCS
00174	0 54 0 00443	153		STM	SCS
00175	0 54 0 00443	154		STM	SCS
00176	0 54 0 00443	155		STM	SCS

00177	0	54	0	00443	156	STM	SCS	Z 71
00200	0	00	0	00000	157	HLT	0	
00201	0	20	0	00100	158	CON	CCON	, 73
00202	0	40	0	00621	159	ITM	SCX	(74
00203	0	00	0	00022	160	HB HLT	'B'	
00204	0	00	0	00025	161	HE HLT	'E'	
00205	2	00	0	00000	162	X2W HLT	0,X2	
00206	0	00	0	00000	163	SSCNL HLT	0	
00207	0	76	0	00000	164	LDA	CHR	
00210	1	72	0	00140	165	SKE	ECHR	TEST FOR =
00211	0	01	0	00245	166	BRU	SCR1	NOT LITERAL
00212	0	43	0	00000	167	BRM	GET	SKIP =
00213	0	43	0	00315	168	BRM	SCAN	
00214	0	43	0	00216	169	BRM	SCNM	
00215	0	51	0	00206	170	BRR	SCNL	EXIT SCNL
00216	0	00	0	00000	171	SSCNM HLT	0	
00217	0	35	0	00015	172	SCK5 STA	LTR1	
00220	0	53	0	00000	173	SKN	PASS	
00221	0	51	0	00216	174	BRR	SCNM	EXIT
00222	0	76	0	00015	175	LDA	LLTR	
00223	0	36	0	00000	176	STB	LTR2	STORE LITERAL
00224	0	75	0	00014	177	LDB	LLT	
00225	0	43	0	01103	178	BRM	SRCH	SEARCH FOR LITERAL
00226	0	01	0	00237	179	BRU	SCK2	NOT IN TABLE
00227	2	76	0	00002	180	LDA	2,X2	LOCATION OF LITERAL
00230	0	75	0	00120	181	SCK3 LDB	Z	
00231	0	72	0	00000	182	SKA	B8	
00232	0	75	0	00000	183	LDB	RELM	
00233	0	14	0	00000	184	ETR	ADDR	
00234	0	35	0	00000	185	STA	VALU	
00235	0	36	0	00000	186	STB	MODE	
00236	0	51	0	00216	187	BRR	SCNM	EXIT SCNM
00237	0	76	0	00000	188	SCK2 LDA	LADD	
00240	0	35	0	00000	189	STA	LTR3	
00241	0	61	0	00237	190	MIN	LADD	INCREMENT LITERAL LOCATION
00242	0	43	0	01205	191	BRM	MOVE	INSERT LITERAL IN TABLE
00243	0	76	0	00240	192	LDA	LTR3	LOCATION OF LITERAL
00244	0	01	0	00230	193	BRU	SCK3	
00245	0	43	0	00247	194	SCR1 BRM	SCNR	GET EXPRESSION OR REFERENCE

5-27

	00246	0	51	0	00206	195	BRR	SCNL		
	00247	0	00	0	00000	196	SCNR	HLT	0	
	00250	0	43	0	00315	197	BRM	SCAN	GET EXPRESSION	
*	00251	0	76	0	00000	198	LDA	VERR	UNDEFINED FLAG	
	00252	0	73	0	00120	199	SKG	Z		
	00253	0	01	0	00313	200	BRU	SCR2	ALL SYMBOL DEFINED	
	00254	0	76	0	00006	201	LDA	CHR1		
	00255	1	72	0	00120	202	SKE	Z	TEST FOR NO CONNECTERS	
	00256	0	01	0	00313	203	BRU	SCR2	UNDEFINED ITEM	
	00257	0	76	0	00120	204	LDA	Z	REFERENCE	
*	00260	0	53	0	00220	205	SKN	PASS		
	00261	0	51	0	00247	206	BRR	SCNR		
*	00262	0	35	0	00251	207	STA	VERR	RESET UNDEFINED FLAG	
*	00263	0	61	0	00000	208	MIN	XERR	SET EXTERNAL FLAG	
	00264	0	76	0	00000	209	LDA	LSYM		
*	00265	0	75	0	00000	210	LDB	LRT		
	00266	0	43	0	01103	211	BRM	SRCH	SEARCH FOR REFERENCE	
	00267	0	01	0	00307	212	BRU	SCR3	NOT IN TABLE	
*	5-28	00270	0	14	0	00233	213	SCR4	ETR	ADDR
*		00271	0	35	0	00234	214	STA	VALU	
*		00272	0	36	0	00235	215	STB	MODE	
*		00273	0	76	0	00000	216	LDA	L0C	
*		00274	0	75	0	00000	217	LDB	REFM	
*		00275	0	72	0	00231	218	SKA	B8	
	00276	0	75	0	00033	219	LDB	RRM		
	00277	2	35	0	00002	220	STA	2,X2		
	00300	2	76	0	00001	221	LDA	1,X2		
	00301	0	14	0	02064	222	ETR	=077770000		
	00302	2	36	0	00001	223	STB	1,X2		
	00303	3	76	0	00001	224	ADM	1,X2		
*	00304	0	76	0	00271	225	LDA	VALU		
*	00305	0	75	0	00272	226	LDB	MODE		
	00306	0	51	0	00247	227	BRR	SCNR	EXIT	
	00307	0	35	0	00037	228	SCR3	STA	NO PREVIOUS REF	
	00310	0	43	0	01205	229	BRM	MOVE	INSERT REFERENCE	
	00311	0	46	3	0003	230	CLR			
	00312	0	01	0	00270	231	BRU	SCR4		
*	00313	0	76	0	00304	232	SCR2	LDA	NO REF OR LIT	
	00314	0	51	0	00247	233	BRR	SCNR	EXIT	

00315	0	00	0	00000	234	\$SCAN	HLT	0	
00316	0	46	30003		235		CLR		
00317	0	35	1	00003	236		STA	*L0P	0 TO BASE CONECTER
* 00320	0	35	0	00313	237		STA	VALU	0 TO VALUE
* 00321	0	35	0	00305	238		STA	M0DE	0 TO M0DE
00322	0	35	0	00006	239		STA	CHR1	RESET
* 00323	0	71	0	00207	240		LDX	CHR,X0	
00324	2	75	0	00106	241		LDB	CTT,X2	
* 00325	0	43	0	00000	242		BRM	SKB	
* 00326	0	00	0	00000	243		HLT	IC	
00327	0	01	0	00337	244		BRU	SCN1	NOT CONECTER
00330	0	01	0	00345	245		BRU	SCN8	
00331	0	61	0	00003	246	SCN3	MIN	L0P	INCR 0P
00332	0	61	0	00004	247		MIN	LITM	INCR ITEM
* 00333	0	76	0	00321	248		LDA	M0DE	
00334	0	35	1	00003	249		STA	*L0P	STORE 0P
* 00335	0	76	0	00320	250		LDA	VALU	
00336	0	35	1	00004	251		STA	*LITM	STORE ITEM
* 5-29 00337	0	76	0	00323	252	SCN1	LDA	CHR	
00340	1	66	0	00000	253		CAX		
00341	0	43	0	00431	254		BRM	SCI	GET NEXT ITEM
* 00342	0	35	0	00335	255		STA	VALU	
* 00343	0	36	0	00333	256		STB	M0DE	
* 00344	0	71	0	00337	257		LDX	CHR,X0	
00345	0	43	0	00660	258	SCN8	BRM	SCC	GET NEXT CONECTER
* 00346	0	35	0	00343	259		STA	M0DE	
00347	0	75	0	00021	260	SCN7	LDB	A4	HIERARCHY MASK
00350	0	73	1	00003	261		SKG	*L0P	M0DE IS IN A
00351	0	01	0	00354	262		BRU	SCN2	LEVEL NOT GREATER
00352	0	70	1	00003	263		SKM	*L0P	
00353	0	01	0	00331	264		BRU	SCN3	LEVEL GREATER
00354	0	76	1	00003	265	SCN2	LDA	*L0P	LAST CONECTER
00355	0	70	0	00120	266		SKM	Z	TEST FOR TERMINATER
00356	0	01	0	00400	267		BRU	SCN4	DO OPERATION
* 00357	0	76	0	00346	268		LDA	M0DE	
00360	0	14	0	00121	269		ETR	C3	MASK M0DE
00361	1	64	0	00000	270		CAB		M0DE TO B
00362	0	76	0	00002	271		LDA	SCNX	
* 00363	1	72	0	00000	272		SKE	LSXT	TEST P LEVEL

	00364	0	01	0	00371	273	BRU	SCN11		NOT 0
	00365	0	76	0	00165	274	LDA	RCHR		
*	00366	1	72	0	00000	275	SKE	TERM		ERRORIF)
	00367	0	01	0	00376	276	BRU	SCN12		
	00370	0	01	0	00373	277	BRU	SCN13		
	00371	0	76	0	00165	278	SCN11 LDA	RCHR		
*	00372	1	72	0	00366	279	SKE	TERM		
*	00373	0	61	0	00000	280	SCN13 MIN	PERR		SET P ERROR
*	00374	0	76	0	00342	281	SCN14 LDA	VALU		
	00375	0	51	0	00315	282	BRR	SCAN		EXIT SCAN
	00376	0	43	0	02041	283	SCN12 BRM	GNF		SKIP TO NEXT FIELD
	00377	0	01	0	00374	284	BRU	SCN14		
	00400	0	75	0	00021	285	SCN4 LDB	A4		
	00401	0	70	0	02065	286	SKM	=05000		
	00402	0	14	0	00022	287	ETR	A5		
	00403	0	14	0	02066	288	ETR	=01700		
	00404	0	6600	006		289	RSH	6		
	00405	1	66	0	00000	290	CAX			OP NUMBER TO X
5-30	00406	0	75	1	00003	291	LDB	*L0P		
	00407	0	02	20001		292	R0V			
	00410	0	76	1	00004	293	LDA	*LITM		
	00411	2	01	1	00412	294	BRU	*SCN5,X2		BRANCH TO OP CODE
	00412	0	01	0	00734	295	SCN5 BRU	CLS		LOGICAL SUM
	00413	0	01	0	00752	296	BRU	CLD		LOGICAL DIFFERENCE
	00414	0	01	0	00754	297	BRU	CLP		LOGICAL PRODUCT
	00415	0	01	0	00756	298	BRU	CAS		ARITHMETIC SUM
	00416	0	01	0	00762	299	BRU	CAD		ARITHMETIC DIFFERENCE
	00417	0	01	0	00770	300	BRU	CAP		ARITHMETIC PRODUCT
	00420	0	01	0	00776	301	BRU	CXQ		EXCLUSIVE QUOTIENT
	00421	0	01	0	00774	302	BRU	CEQ		INCLUSIVE QUOTIENT
	00422	0	01	0	01001	303	BRU	CDS		
	00423	0	01	0	01025	304	BRU	CBS		
*	00424	0	76	0	00000	305	SCN6 LDA	M1		
	00425	1	76	0	00003	306	ADM	L0P		DECR 0P
	00426	1	76	0	00004	307	ADM	LITM		DECR ITEM
*	00427	0	76	0	00357	308	LDA	MODE		
	00430	0	01	0	00347	309	BRU	SCN7		TEST PREVIOUS 0P
	00431	0	00	0	00000	310	SCI	HLT		0
*	00432	0	75	0	00326	311	SCI2 LDB	IC		80

*	00433	0 43 0 00325	312	BRM	SKB	
	00434	2 00 0 00106	313	HLT	CTT,X2	
	00435	0 01 0 00442	314	BRU	SCI1	
*	00436	0 61 0 00000	315	MIN	EERR	SET E FLAG
*	00437	0 43 0 00212	316	BRM	GET	SKIP CHAR
	00440	0 46 30003	317	CLR		
	00441	0 51 0 00431	318	BRR	SCI	EXIT
	00442	2 01 1 00106	319	SCI1	BRU	*CTT,X2
		00000443	320	SCS	EQU	\$
		00000443	321	SC0	EQU	\$
		00000443	322	SCD	EQU	\$
	00443	0 75 0 00143	323	SCIT	LDB	A7
*	00444	0 36 0 00000	324		STB	CNTR
	00445	0 35 0 00007	325		STA	CHR2
	00446	1 72 0 00120	326		SKE	Z
	00447	0 01 0 00457	327		BRU	SCIT7
*	00450	0 43 0 00437	328		BRM	GET
*	00451	0 75 0 00000	329		LDB	SC
*	00452	0 43 0 00433	330		BRM	SKB
5-31	00453	2 00 0 00106	331		HLT	CTT,X2
	00454	0 01 0 00457	332		BRU	SCIT7
	00455	0 46 30003	333		CLR	
	00456	0 51 0 00431	334		BRR	SCI
	00457	0 75 0 00120	335	SCIT7	LDB	Z
	00460	0 01 0 00465	336		BRU	SCIT1
	00461	0 75 0 00036	337	SCIT3	LDB	SM2
	00462	1 77 0 00035	338		XMA	SM1
	00463	0 6720 006	339		LCY	6
	00464	0 16 0 00035	340		MRG	SM1
	00465	0 35 0 00035	341	SCIT1	STA	SM1
	00466	0 36 0 00036	342		STB	SM2
*	00467	0 75 0 00451	343		LDB	SC
*	00470	0 43 0 00000	344		BRM	TCHR
	00471	0 01 0 00474	345		BRU	SCIT2
*	00472	1 73 0 00444	346		SKR	CNTR
	00473	0 01 0 00461	347		BRU	SCIT3
	00474	0 76 0 00035	348	SCIT2	LDA	SM1
	00475	0 16 0 00036	349		MRG	SM2
*	00476	0 72 0 00000	350		SKA	DLY1

MAX CHARACTER COUNT
SAVE LEAD CHAR

SKIP 0

VALID SYMBOL CHARACTER

EXIT WITH ZERO

INSERT NEW CHARACTER

TEST FOR ALPHANUMERIC
END OF SYMBOLIC ITEM
TEST FOR MAX SIZE

TEST ZONE BITS

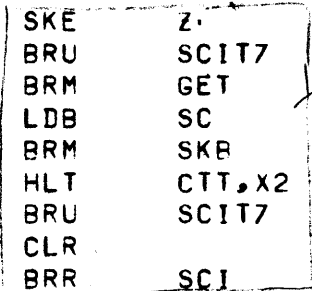

BCD2 DATA 06000
7
120



	00477	0 01 0 00526	351	BRU	SCIT4	SYMBOL
	00500	0 71 0 00120	352	LDX	Z,X0	
	00501	0 75 0 00007	353	LDB	CHR2	
*	00502	0 43 0 00452	354	BRM	SKB	
*	00503	0 00 0 00000	355	HLT	0CTF	
	00504	0 01 0 00510	356	BRU	SCIT21	
	00505	0 71 0 00144	357	LDX	P3,X0	
	00506	0 72 0 02067	358	SKA	=010101010	
*	00507	0 61 0 00436	359	MIN	EERR	
	00510	0 76 0 00036	360	SCIT21 LDA	SM2	HIGH ORDER HALF
	00511	0 43 0 01321	361	BRM	CNVRT	CONVERT
	00512	3 74 0 00062	362	MUL	K3,X2	TIMES BASE TO THE 4TH
	00513	0 36 0 00036	363	STB	SM2	PARTIAL RESULT
	00514	1 72 0 00120	364	SKE	Z	
*	00515	0 61 0 00000	365	MIN	TERR	SET TRUNCATION ERROR
	00516	0 76 0 00035	366	LDA	SM1	LOW ORDER HALF
	00517	0 43 0 01321	367	BRM	CNVRT	CONVERT
	00520	0 02 20001	368	ROV		
5-32	00521	0 55 0 00036	369	ADD	SM2	
	00522	0 40 20001	370	0VT		
*	00523	0 61 0 00515	371	MIN	TERR	SET TRUNCATION ERROR
	00524	0 75 0 00120	372	LDB	Z	0 TO MODE
	00525	0 51 0 00431	373	BRR	SCI	EXIT
	00526	0 76 0 00035	374	SCIT4 LDA	SM1	
	00527	0 75 0 00036	375	LDB	SM2	
	00530	0 01 0 00533	376	BRU	SCIT5	
	00531	0 6720 006	377	SCIT6 LCY	6	ADJUST
*	00532	0 16 0 00000	378	MRG	BCHR	INSERT BLANK
*	00533	1 73 0 00472	379	SCIT5 SKR	CNTR	TEST FOR SYMBOL ADJUSTED
	00534	0 01 0 00531	380	BRU	SCIT6	
	00535	0 14 0 02064	381	ETR	=077770000	
	00536	0 35 0 00036	382	STA	SM2 ^{C5 C6}	
	00537	0 36 0 00035	383	STB	SM1 ^{C1 C2 C3 C4}	
	00540	0 76 0 00000	384	LDA	LSYM	LOCATION OF SYMBOL
*	00541	0 75 0 00000	385	LDB	LST	LOCATION OF SYMBOL TABLE
	00542	0 43 0 01103	386	BRM	SRCH	SEARCH
*	00543	0 61 0 00262	387	MIN	VERR	NOT FOUND
	00544	0 46 00014	388	XAB		
	00545	0 72 0 00145	389	SKA	B17	

*	00546	0 61 0 00000	390	MIN	DERR	
	00547	0 14 0 00121	391	ETR	C3	SAVE MODE
	00550	0 46 00014	392	XAB		
*	00551	0 43 0 00502	393	BRM	SKB	
*	00552	0 00 0 00232	394	HLT	RELM	
*	00553	0 14 0 00270	395	ETR	ADDR	
	00554	0 51 0 00431	396	BRR	SCI	EXIT
*	00555	0 76 0 00344	397	SCL LDA	CHR	
*	00556	1 72 0 00000	398	SKE	SCHR	TEST FOR *
	00557	0 01 0 00570	399	BRU	SCL1	\$ IS ALWAYS LOCATION COUNTER
*	00560	0 43 0 00450	400	BRM	GET	
	00561	1 66 0 00000	401	CAX		
*	00562	0 75 0 00000	402	LDB	CC	
*	00563	0 43 0 00551	403	BRM	SKB	
	00564	2 00 0 00106	404	HLT	CTT,X2	
	00565	0 01 0 00571	405	BRU	SCL2	
*	00566	0 61 0 00000	406	MIN	IFLG	
	00567	0 01 0 00432	407	BRU	SCI2	
*	00570	0 43 0 00560	408	SCL1 BRM	GET	
*	00571	0 76 0 00273	409	SCL2 LDA	L0C	
	00572	0 75 0 00120	410	LDB	Z	
*	00573	0 72 0 00275	411	SKA	B8	
*	00574	0 75 0 00552	412	LDB	RELM	
*	00575	0 14 0 00553	413	ETR	ADDR	
	00576	0 51 0 00431	414	BRR	SCI	EXIT
	00577	0 76 0 00120	415	SCA LDA	Z	
	00600	0 01 0 00610	416	BRU	SCA2	
*	00601	0 76 0 00374	417	SCA1 LDA	VALU	
	00602	0 72 0 00024	418	SKA	CO	
*	00603	0 61 0 00523	419	MIN	TERR	
	00604	0 72 0 00024	420	SKA	CO	
	00605	0 01 0 00615	421	BRU	SCA3	
	00606	0 6700 006	422	LSH	6	
*	00607	0 16 0 00555	423	MRG	CHR	INSERT NEW CHAR
*	00610	0 35 0 00601	424	SCA2 STA	VALU	
*	00611	0 43 0 00570	425	BRM	GET	GET CHAR
	00612	0 75 0 00120	426	LDB	Z	
	00613	1 72 0 00164	427	SKE	QCHR	TEST FOR QUOTE
	00614	0 01 0 00601	428	BRU	SCA1	ALF CHAR

*	00615	0 43 0	00611	429	SCA3	BRM	GET	
	00616	0 75 0	00120	430		LDB	Z	
*	00617	0 76 0	00610	431		LDA	VALU	
	00620	0 51 0	00431	432		BRR	SCI	EXIT
	00621	0 76 0	00016	433	SCX	LDA	SCN0	
	00622	0 73 0	00002	434		SKG	SCNX	
	00623	0 01 0	00651	435		BRU	SCX1	TOO MANY LEVELS
	00624	0 76 0	00315	436		LDA	SCAN	
	00625	0 35 1	00002	437		STA	*SCNX	SAVE EXIT
	00626	0 76 0	00431	438		LDA	SCI	
	00627	0 35 1	00005	439		STA	*SCIX	
	00630	0 61 0	00005	440		MIN	SCIX	
	00631	0 61 0	00002	441		MIN	SCNX	INCR
	00632	0 61 0	00003	442		MIN	L0P	
	00633	0 61 0	00004	443		MIN	LITM	
*	00634	0 43 0	00615	444		BRM	GET	SKIP (
	00635	0 43 0	00315	445		BRM	SCAN	GET SUB-EXPRESSION
*	00636	0 76 0	00424	446		LDA	M1	
5-34	00637	1 76 0	00002	447		ADM	SCNX	DECR
	00640	1 76 0	00003	448		ADM	L0P	
	00641	1 76 0	00004	449		ADM	LITM	
	00642	1 76 0	00005	450		ADM	SCIX	
	00643	0 76 1	00005	451		LDA	*SCIX	
	00644	0 35 0	00431	452		STA	SCI	
	00645	0 76 1	00002	453		LDA	*SCNX	
	00646	0 35 0	00315	454		STA	SCAN	RESTORE EXIT
*	00647	0 76 0	00617	455		LDA	VALU	
	00650	0 51 0	00431	456		BRR	SCI	EXIT
*	00651	0 61 0	00373	457	SCX1	MIN	PERR	SET P FLAG
*	00652	0 43 0	00634	458	SCX2	BRM	GET	
	00653	1 72 0	00165	459		SKE	RCHR	
	00654	0 01 0	00652	460		BRU	SCX2	SKIP SUB-EXPRESSION
*	00655	0 43 0	00652	461		BRM	GET	SKIP)
	00656	0 46 3	00003	462		CLR		
	00657	0 51 0	00431	463		BRR	SCI	EXIT
	00660	0 00 0	00000	464	SCC	HLT	0	
*	00661	0 75 0	00562	465		LDB	CC	
*	00662	0 43 0	00563	466		BRM	SKB	
	00663	2 00 0	00106	467		HLT	CTT,X2	

00664	0	01	0	00672	468	BRU	SCC1	
* 00665	0	35	0	00372	469	STA	TERM	
* 00666	0	61	0	00507	470	MIN	EERR	SET E FLAG
* 00667	0	43	0	00655	471	BRM	GET	SKIP CHAR
* 00670	0	76	0	00427	472	LDA	MODE	
00671	0	51	0	00660	473	BRR	SCC	EXIT
00672	1	67	0	00000	474	SCC1 CXA		
* 00673	1	72	0	00556	475	SKE	SCHR	CONNECTER IS AP IF *
00674	0	01	0	00711	476	BRU	SCC7	
00675	0	35	0	00006	477	STA	CHR1	
* 00676	0	43	0	00667	478	BRM	GET	
00677	1	72	0	02070	479	SKE	='+'	
00700	0	01	0	00703	480	BRU	SCC5	
00701	0	75	0	02065	481	LDB	=05000	
00702	0	01	0	00732	482	BRU	SCC8	
00703	0	75	0	00057	483	SCC5 LDB	AP	
00704	0	36	0	00011	484	STB	CNCT	
00705	1	72	0	02071	485	SKE	='/'	
5-35 00706	0	01	0	00727	486	BRU	SCC6	
00707	0	75	0	02072	487	LDB	=05100	
00710	0	01	0	00732	488	BRU	SCC8	
00711	2	75	0	00106	489	SCC7 LDB	CTT,X2	
00712	0	36	0	00011	490	STB	CNCT	SAVE CONNECTER
* 00713	0	43	0	00662	491	BRM	SKB	
00714	0	00	0	00021	492	HLT	A4	
00715	0	01	0	00724	493	BRU	SCC2	NOT TERMINATER
* 00716	0	37	0	00665	494	STX	TERM,X0	SAVE TERMINATER
* 00717	0	43	0	00676	495	SCC4 BRM	GET	POSITION AT NEXT CHAR
00720	0	76	0	00011	496	SCC3 LDA	CNCT	
00721	0	14	0	00025	497	ETR	C2	EXTRACT CONNECTER
* 00722	0	16	0	00670	498	MRG	MODE	
00723	0	51	0	00660	499	BRR	SCC	EXIT
00724	0	35	0	00006	500	SCC2 STA	CHR1	SAVE CHAR
* 00725	0	43	0	00717	501	BRM	GET	GET NEXT CHAR
00726	0	75	0	00011	502	LDB	CNCT	
00727	1	72	0	00006	503	SCC6 SKE	CHR1	
00730	0	01	0	00720	504	BRU	SCC3	
00731	0	6700	006	505	505	LSH	6	USE ALTERNATE CONNECTER
00732	0	36	0	00011	506	SCC8 STB	CNCT	

	00733	0	01	0	00717	507	BRU	SCC4	
*	00734	0	16	0	00647	508	CLS	MRG	VALU
									V = L++V
*	00735	0	35	0	00734	509	CLS1	STA	VALU
*	00736	0	76	0	00722	510		LDA	MODE
*	00737	0	16	1	00003	511		MRG	*L0P
									ERROR IF EITHER ARE REL
*	00740	0	72	0	00574	512	CLS2	SKA	RELM
*	00741	0	61	0	00000	513		MIN	RERR
	00742	0	40	20001		514		0VT	
*	00743	0	61	0	00603	515		MIN	TERR
									SET TRUNCATION ERROR
*	00744	0	76	0	00736	516		LDA	MODE
*	00745	0	17	0	00740	517		E0R	RELM
	00746	0	46	00014		518		XAB	
*	00747	0	72	0	00745	519		SKA	RELM
*	00750	0	36	0	00744	520		STB	MODE
	00751	0	01	0	00424	521		BRU	SCN6
*	00752	0	17	0	00735	522	CLD	E0R	VALU
									V=L--V
*	00753	0	01	0	00735	523		BRU	CLS1
*	00754	0	14	0	00752	524	CLP	ETR	VALU
									V=L**V
5-36	00755	0	01	0	00735	525		BRU	CLS1
*	00756	1	76	0	00754	526	CAS	ADM	VALU
									V=L+V
*	00757	0	76	0	00750	527		LDA	MODE
	00760	0	14	1	00003	528		ETR	*L0P
									ERROR IF BOTH ARE REL
*	00761	0	01	0	00740	529		BRU	CLS2
*	00762	0	54	0	00756	530	CAD	SUB	VALU
	00763	0	35	0	00762	531		STA	VALU
									V=L-V
*	00764	0	76	1	00003	532		LDA	*L0P
*	00765	0	17	0	00636	533		E0R	M1
									COMPLEMENT OF U MODE
*	00766	0	14	0	00757	534		ETR	MODE
									ERROR IF V REL AND U NOT
	00767	0	01	0	00740	535		BRU	CLS2
									ERROR IF V IS REL
*	00770	1	74	0	00763	536	CAP	MUL	VALU
	00771	0	6700	027		537		LSH	23
									V=L*V
	00772	0	75	1	00003	538	CAP1	LDB	*L0P
									RESTORE B
	00773	0	01	0	00735	539		BRU	CLS1
*	00774	0	55	0	00765	540	CEQ	ADD	M1
*	00775	0	55	0	00770	541		ADD	VALU
									L+V-1
	00776	0	6600	027		542	CXQ	RSH	23
*	00777	1	75	0	00775	543		DIV	VALU
									L/V OR (L+V-1)/V
	01000	0	01	0	00772	544		BRU	CAP1
*	01001	0	76	0	00777	545	CDS	LDA	VALU

*	01002	0	73	0	00774	546	SKG	M1
	01003	1	71	0	00000	547	CNA	
	01004	0	73	0	00031	548	SKG	P9
	01005	0	01	0	01007	549	BRU	\$+2
*	01006	0	61	0	00743	550	MIN	TERR
	01007	1	66	0	00000	551	CAX	
	01010	0	75	0	00120	552	LDB	Z
	01011	0	02	2	00001	553	R0V	
	01012	2	76	0	00066	554	LDA	FIVES,X2
	01013	2	67	00	000	555	LSH	O,X2
	01014	0	40	2	00001	556	0VT	
*	01015	0	61	0	01006	557	MIN	TERR
*	01016	1	77	0	01001	558	XMA	VALU
*	01017	0	73	0	01002	559	SKG	M1
	01020	0	01	0	01023	560	BRU	CDS1
	01021	0	76	1	00004	561	LDA	*LITM
	01022	0	01	0	00770	562	BRU	CAP
	01023	0	76	1	00004	563	CDS1 LDA	*LITM
	01024	0	01	0	00776	564	BRU	CXQ
*	01025	0	76	0	01016	565	CRS LDA	VALU
*	01026	0	53	0	01025	566	SKN	VALU
	01027	0	01	0	01043	567	BRU	CBS1
	01030	1	71	0	00000	568	CNA	
	01031	1	66	0	00000	569	CAX	
	01032	0	75	0	00120	570	LDB	Z
	01033	0	76	1	00004	571	LDA	*LITM
	01034	2	66	00	000	572	RSH	O,X2
*	01035	0	43	0	00713	573	BRM	SKB
*	01036	0	00	0	01017	574	HLT	M1
	01037	0	73	1	00004	575	SKG	*LITM
	01040	0	01	0	00772	576	BRU	CAP1
	01041	0	55	0	00066	577	ADD	0NE
	01042	0	01	0	00772	578	BRU	CAP1
	01043	1	66	0	00000	579	CBS1 CAX	
	01044	0	75	0	00120	580	LDB	Z
	01045	0	76	1	00004	581	LDA	*LITM
	01046	2	67	00	000	582	LSH	O,X2
	01047	0	01	0	00772	583	BRU	CAP1
	01050	0	00	0	00000	584	SSYM HLT	O

01051	0 75 0 00120	585	LDB	Z	MRG A4	
01052	0 35 0 00035	586	SYM2	STA	SM1	
01053	0 36 0 00036	587		STB	SM2	
* 01054	0 75 0 00467	588		LDB	SC	
* 01055	0 43 0 00470	589		BRM	TCHR	TEST FOR SYMBOL CHAR
01056	0 01 0 01067	590		BRU	SYM1	END SYMBOL
01057	0 75 0 00036	591		LDB	SM2	
01060	1 77 0 00035	592		XMA	SM1	
* 01061	0 43 0 01035	593		BRM	SKB	
01062	0 00 0 00025	594		HLT	62 SC	
01063	0 01 0 01077	595		BRU	SYM3	
01064	0 6720 006	596		LCY	6	
01065	0 16 0 00035	597		MRG	SM1	
01066	0 01 0 01052	598		BRU	SYM2	
01067	0 75 0 00036	599	SYM1	LDB	SM2	
01070	0 76 0 00035	600		LDA	SM1	
* 01071	0 43 0 01061	601	SYM4	BRM	SKB	
01072	0 00 0 00025	602		HLT	62 SC	
01073	0 01 0 01077	603		BRU	SYM3	
01074	0 6720 006	604		LCY	6	
* 01075	0 16 0 00532	605		MRG	BCHR	
01076	0 01 0 01071	606		BRU	SYM4	
01077	0 6620 014	607	SYM3	RCY	12 18	LSH 6
01100	0 35 0 00035	608		STA	SM1	
01101	0 36 0 00036	609		STB	SM2	
01102	0 51 0 01050	610		BRR	SYM	EXIT
01103	0 00 0 00000	611	SSRCH	HLT	0	
01104	0 35 0 00042	612		STA	LKI	SAVE ITEM LOC
01105	0 36 0 00046	613		STB	LKT	SAVE PACKET LOC
01106	1 66 0 00000	614		CAX		LOC OF ITEM
01107	2 76 0 00000	615		LDA	0,X2	
01110	0 35 0 00040	616		STA	KEY1	
01111	2 76 0 00001	617		LDA	1,X2	
01112	1 70 0 00000	618		CBX		
01113	2 14 0 00003	619		ETR	3,X2	
01114	0 35 0 00041	620		STA	KEY2	STORE KEY
01115	2 76 0 00000	621		LDA	0,X2	T = END OF TABLE
01116	0 35 0 00045	622		STA	LKS	S = T
01117	2 76 0 00001	623		LDA	1,X2	F = LOC OF 1ST ITEM

5-38

01120	2	75	0	00003	624	LDB	3,X2	
01121	0	36	0	00043	625	STB	LKM	MASK FOR 2ND KEY WORD
01122	2	75	0	00002	626	LDB	2,X2	I = INITIAL INCR
01123	0	01	0	01132	627	BRU	LK1	
01124	0	6600	001		628	LK3 RSH	1	
01125	2	76	0	00000	629	LDA	0,X2	K(X)
01126	0	73	0	00040	630	SKG	KEY1	COMPARE WITH K(L)
01127	0	01	0	01142	631	BRU	LK2	K(L) GREATER OR EQUAL
01130	1	65	0	00000	632	LK7 CBA		
01131	0	55	0	00045	633	ADD	LKS	
01132	1	66	0	00000	634	LK1 CAX		
01133	0	76	0	00120	635	LDA	Z	
01134	0	43	0	01071	636	BRM	SKB	
01135	0	00	0	00100	637	HLT	M2	
01136	0	01	0	01124	638	BRU	LK3	
01137	0	46	30003		639	CLR		NOT FOUND
01140	0	71	0	00045	640	LDX	LKS,X0	
01141	0	01	0	01153	641	BRU	LK5	
01142	1	72	0	00040	642	LK2 SKE	KEY1	
01143	0	01	0	01155	643	BRU	LK4	KEYS NOT EQUAL
01144	2	76	0	00001	644	LDA	1,X2	2ND WORD OF KEY
01145	0	14	0	00043	645	ETR	LKM	MASK OUT MODE
01146	1	72	0	00041	646	SKE	KEY2	TEST FOR EQUAL KEYS
01147	0	01	0	01154	647	BRU	LK6	KEYS NOT EQUAL
01150	0	61	0	01103	648	MIN	SRCH	TAPE FOUND EXIT
01151	2	75	0	00001	649	LDB	1,X2	MODE
01152	2	76	0	00002	650	LDA	2,X2	VALUE
01153	0	51	0	01103	651	LK5 BRR	SRCH	EXIT
01154	0	73	0	00041	652	LK6 SKG	KEY2	COMPARE 2ND WORDS
01155	0	37	0	00045	653	LK4 STX	LKS,X0	K(L) GREATER, S = X
01156	0	01	0	01130	654	BRU	LK7	
01157	0	00	0	00000	655	\$NSRT HLT	0	
01160	0	43	0	01103	656	BRM	SRCH	SEARCH FOR ITEM
01161	0	01	0	01201	657	BRU	NS3	NOT FOUND
01162	0	61	0	00042	658	MIN	LKI	
01163	0	76	1	00042	659	LDA	*LKI	
01164	0	61	0	00042	660	MIN	LKI	
01165	0	75	1	00042	661	LDB	*LKI	
01166	3	72	0	00001	662	SKE	1,X2	

01167	0 01 0	01174	663	BRU	NS1	1ST WORD NOT EQUAL
01170	0 46 00014		664	XAB		
01171	3 72 0	00002	665	SKE	2,X2	
01172	0 01 0	01174	666	BRU	NS1	2ND WORDS NOT EQUAL
01173	0 51 0	01157	667	BRR	NSRT	EXIT
* 01174	0 76 0	00000	668	NS1 LDA	DUPM	
01175	2 16 0	00001	669	MRG	1,X2	SET DUP FLAG
01176	2 35 0	00001	670	STA	1,X2	
* 01177	0 61 0	00546	671	MIN	DERR	SET DUP ERROR
01200	0 51 0	01157	672	BRR	NSRT	EXIT
01201	0 43 0	01205	673	NS3 BRM	MOVE	MOVE ITEM TO TABLE
01202	0 51 0	01157	674	BRR	NSRT	EXIT
* 01203	0 61 0	00000	675	0FL0 MIN	0ERR	
01204	0 51 0	01205	676	BRR	MOVE	
01205	0 00 0	00000	677	MOVE HLT	0	
01206	0 76 0	00144	678	LDA	P3	
* 01207	1 76 0	00000	679	ADM	LIMIT	-(M-3) TO M
* 01210	0 53 0	01207	680	SKN	LIMIT	
5-40 01211	0 01 0	01203	681	BRU	0FL0	
01212	0 37 0	00044	682	STX	LKP,X0	SAVE P
01213	0 71 0	00046	683	LDX	LKT,X0	PACKET LOCATION
01214	0 76 0	00205	684	LDA	X2W	CONSTRUCTION INDIRECT WORD
01215	0 16 0	00044	685	MRG	LKP	P,X2
01216	2 53 0	00005	686	SKN	5,X2	TYPE (UP OR DOWN)
01217	0 01 0	01274	687	BRU	MOV1	MOVE UP
01220	0 35 0	00043	688	STA	LKM	P,X2 (TO)
01221	0 55 0	00144	689	ADD	P3	P+3,X2 (FORM)
01222	0 35 0	00045	690	STA	LKS	P+3,X2 (FORM)
01223	2 76 0	00000	691	LDA	0,X2	B
01224	0 54 0	00044	692	SUB	LKP	NO. OF WORDS TO MOVE
01225	0 55 0	02073	693	ADD	=0177777	
01226	1 66 0	00000	694	CAX		
01227	0 01 0	01232	695	BRU	MOV2	
01230	0 76 1	00045	696	MOV3 LDA	*LKS	
01231	0 35 1	00043	697	STA	*LKM	MOVE ONE WORD DOWN 3
01232	0 41 0	01230	698	MOV2 BRX	MOV3,X0	
01233	0 71 0	02074	699	MOV1 LDX	=00200000-3,X0	
01234	0 76 0	00045	700	LDA	LKS	
01235	0 54 0	00144	701	SUB	P3	

01236	0	35	0	00044	702	STA	LKP	LOCATION OF INSERTED ITEM
01237	0	76	1	00042	703	M0V4 LDA	*LKI	
01240	0	35	1	00045	704	STA	*LKS	INSERT NEW ITEM
01241	0	61	0	00042	705	MIN	LKI	
01242	0	41	0	01237	706	BRX	M0V4,X0	
01243	0	71	0	00046	707	LDX	LKT,X0	PACKET LOCATION
01244	0	76	0	00144	708	LDA	P3	
01245	3	76	0	00004	709	ADM	4,X2	N+3 TO N
01246	2	76	0	00002	710	LDA	2,X2	M
01247	2	73	0	00004	711	SKG	4,X2	M=N
01250	0	01	0	01263	712	BRU	M0V5	M=N
01251	2	53	0	00005	713	SKN	5,X2	TYPE
01252	0	01	0	01257	714	BRU	M0V8	UP TABLE
01253	2	76	0	00000	715	LDA	0,X2	
01254	0	54	0	00144	716	MV2 SUB	P3	
01255	2	35	0	00000	717	STA	0,X2	B-3 TO B
01256	0	01	0	01261	718	BRU	MV3	
01257	0	76	0	00144	719	M0V8 LDA	P3	
01260	3	76	0	00001	720	ADM	1,X2	F+3 TO F
01261	0	71	0	00044	721	MV3 LDX	LKP,X0	LOCATION OF INSERTED ITEM
01262	0	51	0	01205	722	BRR	M0VE	EXIT
01263	0	75	0	00120	723	M0V5 LDB	Z	
01264	2	55	0	00004	724	ADD	4,X2	M+N TO M
01265	2	35	0	00002	725	STA	2,X2	
01266	2	36	0	00004	726	STB	4,X2	0 TO N
01267	2	76	0	00000	727	LDA	0,X2	B
01270	2	53	0	00005	728	SKN	5,X2	
01271	0	55	0	00144	729	ADD	P3	B + 3 TO B
01272	2	35	0	00001	730	STA	1,X2	B TO F
01273	0	01	0	01254	731	BRU	MV2	
01274	0	55	0	00124	732	M0V1 ADD	B22	
01275	0	14	0	00034	733	ETR	XADR	CONSTRUCT INDIRECT WORD
01276	0	35	0	00045	734	STA	LKS	P+2,X2 (FROM)
01277	0	55	0	00144	735	ADD	P3	
01300	0	35	0	00043	736	STA	LKM	P+5,X2 (TO)
01301	2	76	0	00000	737	LDA	0,X2	B
01302	2	55	0	00002	738	ADD	2,X2	B+M
01303	2	55	0	00004	739	ADD	4,X2	B+M+N
01304	0	54	0	00044	740	SUB	LKP	B+M+N-P

01305	0	73	0	00120	741	SKG	Z	NO. OF WORDS TO MOVE
01306	0	01	0	01315	742	BRU	M0V6	0 WORDS
01307	0	16	0	02075	743	MRG	=040000*/S9300	
01310	1	66	0	00000	744	CAX		
01311	0	76	1	00045	745	M0V7 LDA	*LKS	
01312	0	35	1	00043	746	STA	*LKM	MOVE ONE WORD UP 3
01313	2	77	0	37776	747	EAX	-2,X2	
01314	0	41	0	01311	748	BRX	M0V7,X0	
01315	0	76	0	00043	749	M0V6 LDA	LKM	P+5,X2
01316	0	55	0	00066	750	ADD	B23	P+6,X2
01317	0	35	0	00045	751	STA	LKS	
01320	0	01	0	01233	752	BRU	MV1	
01321	0	00	0	00000	753	CNVRT HLT	0	
* 01322	0	35	0	01026	754	STA	VALU	
01323	0	14	0	00026	755	ETR	CO2	MASK 1ST AND 3RD CHARACTERS
01324	3	74	0	00060	756	MUL	K1,X2	TIMES BASE - 64
* 01325	0	55	0	01322	757	ADD	VALU	
* 01326	0	35	0	01325	758	STA	VALU	
5-42 01327	0	14	0	02064	759	ETR	=077770000	
* 01330	3	74	0	00061	760	MUL	K2,X2	TIMES BASE SQUARED - 4096
* 01331	0	55	0	01326	761	ADD	VALU	RESULT
01332	0	51	0	01321	762	BRR	CNVRT	EXIT
01333	0	00	0	00000	763	SSIGN HLT	0	
* 01334	0	76	0	00607	764	LDA	CHR	
* 01335	0	35	0	00716	765	STA	TERM	
01336	0	75	0	00120	766	LDB	Z	
01337	0	36	0	00047	767	STB	SIGN.	+ TO SIGN
01340	1	72	0	00141	768	SKE	MCHR	TEST FOR -
* 01341	0	01	0	01345	769	BRU	SSIGN1	
* 01342	0	75	0	01036	770	LDB	M1	
01343	0	36	0	00047	771	STB	SIGN	- TO SIGN
01344	0	01	0	01347	772	BRU	SSIGN2	
01345	1	72	0	00160	773	SSIGN1 SKE	PLUS	TEST FOR +
01346	0	01	0	01350	774	BRU	SSIGN3	
* 01347	0	43	0	00725	775	SSIGN2 BRM	GET	SKIP + OR -
01350	0	51	0	01333	776	SSIGN3 BRR	SSIGN	EXIT
01351	0	00	0	00000	777	DPMT HLT	0	
* 01352	0	36	0	00000	778	STB	WORD	LOW
01353	1	74	0	00032	779	MUL	P5	10*HOW TO B

*	01354	0 76 0 01352	780	LDA	WORD	LOW
*	01355	0 36 0 01354	781	STB	WORD	
	01356	0 6620 001	782	RCY	1	MJL CLEARS B23
	01357	1 74 0 02076	783	MUL	=10	
	01360	0 02 20001	784	R0V		
*	01361	0 55 0 01355	785	ADD	WORD	10*HIGH + CARRY
	01362	0 40 20001	786	0VT		
*	01363	0 61 0 01015	787	MIN	TERR	SET TRUNCATION ERROR
	01364	0 51 0 01351	788	BRR	DPMT	EXIT
	01365	0 00 0 00000	789	HLT	0	
	01366	0 35 0 00012	790	STA	TEMP	
*	01367	0 76 0 00000	791	LDA	WRD2	
	01370	0 14 0 00100	792	ETR	M2	
	01371	0 6600 001	793	RSH	1	
	01372	0 14 0 02077	794	ETR	=037777777	
	01373	0 36 0 00013	795	STB	TEMP+1	
	01374	0 55 0 00013	796	ADD	TEMP+1	
	01375	0 6600 027	797	RSH	23	
	01376	0 14 0 00066	798	ETR	0NE	
	01377	0 02 20001	799	R0V		
	01400	0 55 0 00012	800	ADD	TEMP	
*	01401	0 55 0 00000	801	ADD	WRD1	
	01402	0 40 20001	802	0VT		
*	01403	0 61 0 01363	803	MIN	TERR	SET TRUNCATION ERROR
	01404	0 51 0 01365	804	BRR	DPA	EXIT
	01405	0 00 0 00000	805	HLT	0	
*	01406	0 76 0 01401	806	LDA	WRD1	
*	01407	0 75 0 01367	807	LDB	WRD2	
*	01410	0 36 0 01361	808	STB	WORD	X2
	01411	1 74 0 00055	809	MUL	MULT1	
*	01412	1 77 0 01406	810	XMA	WRD1	X1 TO A, SAVE H
*	01413	0 36 0 01407	811	STB	WRD2	SAVE L
	01414	1 74 0 00056	812	MUL	MULT2	
	01415	0 6600 027	813	RSH	23	
	01416	0 14 0 00066	814	ETR	0NE	
	01417	0 43 0 01365	815	BRM	DPA	AB + HL TO AB
*	01420	0 35 0 01412	816	STA	WRD1	SAVE H
*	01421	0 36 0 01413	817	STB	WRD2	SAVE L
*	01422	0 76 0 01410	818	LDA	WORD	X2

01423	0	6600	001	819	RSH	1	
01424	0	14	0 02077	820	ETR	=037777777	
01425	1	74	0 00055	821	MUL	MULT1	
01426	0	6600	027	822	RSH	23	
01427	0	14	0 00066	823	ETR	ONE	
01430	0	43	0 01365	824	BRM	DPA	AB+HL TO AB
* 01431	0	35	0 01420	825	STA	WRD1	
* 01432	0	36	0 01421	826	STB	WRD2	
01433	0	51	0 01405	827	BRR	DPNM	EXIT
01434	0	00	0 00000	828	\$DPW	HLT	0
01435	0	76	0 00052	829	LDA	SCALE	
01436	0	35	0 00051	830	STA	BEXP	SCALING (IF NOT SPECIFIED)
01437	0	75	0 00120	831	LDB	Z	
* 01440	0	36	0 01431	832	STB	WRD1	CLEAR H0W
* 01441	0	36	0 01432	833	STB	WRD2	CLEAR L0W
* 01442	0	75	0 01342	834	LDB	M1	
01443	0	36	0 00054	835	STB	FFLG	RESET FLOATING FLAG
01444	0	36	0 00053	836	STB	DEXP	-1 TO DECIMAL EXPONNET
5-44 01445	0	43	0 01333	837	BRM	SSIGN	SET SIGN
01446	0	75	0 00047	838	LDB	SIGN	
01447	0	36	0 00050	839	STB	DPSIGN	SET DP SIGN
01450	1	72	0 00163	840	DPW3	SKE	TEST FOR .
01451	0	01	0 01472	841	BRU	DPW4	
01452	0	61	0 00054	842	MIN	FFLG	SET FLOAT FLAG
01453	0	01	0 01465	843	BRU	DPW2	
* 01454	0	55	0 01334	844	DPW1	ADD	2*CHR TO A
* 01455	1	77	0 01441	845	XMA	WRD2	2*CHR TO L
01456	0	46	20005	846	ABC		L TO B
* 01457	1	77	0 01440	847	XMA	WRD1	H TO A, 0 TO H
01460	0	43	0 01351	848	BRM	DPMT	10*AB TO AB
01461	0	43	0 01365	849	BRM	DPA	10*AB+CHR TO AB
* 01462	0	35	0 01457	850	STA	WRD1	SAVE H
* 01463	0	36	0 01455	851	STB	WRD2	SAVE L
01464	0	53	0 00053	852	SKN	DEXP	SKIP UNLESS PERIOD SEEN
01465	0	61	0 00053	853	DPW2	MIN	INCR DECIMAL EXPONENT
* 01466	0	75	0 00000	854	LDB	DC	
* 01467	0	43	0 01055	855	BRM	TCHR	TEST FOR DECIMAL DIGIT
01470	0	01	0 01450	856	BRU	DPW3	
01471	0	01	0 01454	857	BRU	DPW1	

	01472	1	66	0	00000	858	DPW4	CAX		
*	01473	0	75	0	01466	859		LDB	DC	
*	01474	0	43	0	01134	860		BRM	SKB	
	01475	2	00	0	00106	861		HLT	CTT,X2	
	01476	0	01	0	01454	862		BRU	DPW1	
	01477	0	76	0	00120	863		LDA	Z	
	01500	0	53	0	00053	864		SKN	DEXP	TEST FOR PERIOD
	01501	0	54	0	00053	865		SUB	DEXP	DECIMAL EXPONENT
	01502	0	35	0	00053	866		STA	DEXP	
*	01503	0	76	0	01454	867		LDA	CHR	
	01504	1	72	0	00204	868	DECK2	SKE	HE	
	01505	0	01	0	01512	869		BRU	DECK3	
*	01506	0	43	0	01347	870		BRM	GET	
	01507	0	43	0	02007	871		BRM	DECW	
	01510	1	76	0	00053	872	DECK6	ADM	DEXP	
*	01511	0	76	0	01503	873		LDA	CHR	
	01512	1	72	0	00203	874	DECK3	SKE	HB	
	01513	0	01	0	01524	875		BRU	DECK4	
*	01514	0	43	0	01506	876		BRM	GET	
5-45	01515	0	43	0	02007	877		BRM	DECW	
	01516	1	71	0	00000	878		CNA		
	01517	0	35	0	00051	879	DECK8	STA	BEXP	
*	01520	0	76	0	01442	880		LDA	M1	
	01521	0	35	0	00054	881		STA	FFLG	
*	01522	0	76	0	01511	882		LDA	CHR	
	01523	0	01	0	01504	883		BRU	DECK2	
	01524	1	72	0	02100	884	DECK4	SKE	=*'	
	01525	0	01	0	01543	885		BRU	DECK5	
*	01526	0	43	0	01514	886		BRM	GET	
	01527	1	72	0	02070	887		SKE	=*'	
	01530	0	01	0	01535	888		BRU	DECK7	
*	01531	0	43	0	01526	889		BRM	GET	
	01532	0	43	0	00431	890		BRM	SCI	
	01533	1	76	0	00053	891		ADM	DEXP	
	01534	0	01	0	01503	892		BRU	DECK2-1	
	01535	1	72	0	02071	893	DECK7	SKE	=*'	
	01536	0	01	0	01543	894		BRU	DECK5	
*	01537	0	43	0	01531	895		BRM	GET	
	01540	0	43	0	00431	896		BRM	SCI	

	01541	0 55 0 00051	897	ADD	BEXP	
	01542	0 01 0 01517	898	BRU	DECK8	
*	01543	0 76 0 01462	899	DECK5 LDA	WRD1	
*	01544	0 75 0 01463	900	LDB	WRD2	
	01545	0 71 0 00120	901	LDX	Z,XO	
	01546	0 6710 056	902	NØD	46	NORMALIZE
*	01547	0 35 0 01543	903	STA	WRD1	
*	01550	0 36 0 01544	904	STB	WRD2	
	01551	1 67 0 00000	905	CXA		
	01552	0 6720 011	906	LCY	9	
	01553	0 6600 011	907	RSH	9	
	01554	0 73 0 02101	908	SKG	--46	
	01555	0 76 0 02101	909	LDA	--46	
	01556	0 53 0 00053	910	SKN	DEXP	
	01557	0 55 0 00125	911	ADD	P24	
	01560	1 76 0 00051	912	ADM	BEXP	MODIFY BINARY EXPONENT
	01561	0 53 0 00053	913	SKN	DEXP	TEST SIGN OF DECIMAL EXPONENT
	01562	0 01 0 01655	914	BRU	DPW5A	
	01563	0 46 30003	915	CLR		
	01564	0 54 0 00053	916	SUB	DEXP	
	01565	0 01 0 01571	917	BRU	DPW9	
	01566	0 76 0 02101	918	DPW91 LDA	--46	
	01567	1 76 0 00051	919	ADM	BEXP	
	01570	0 76 0 00053	920	LDA	DEXP	
	01571	0 75 0 00120	921	DPW9 -LDB	Z	
	01572	0 36 0 00053	922	STB	DEXP	O TO D
	01573	0 73 0 00031	923	SKG	P9	TEST RANGE
	01574	0 01 0 01600	924	BRU	DPW6	
	01575	0 54 0 00031	925	SUB	P9	
	01576	0 35 0 00053	926	STA	DEXP	D-9 TO D
	01577	0 76 0 00031	927	LDA	P9	
	01600	1 66 0 00000	928	DPW6 CAX		
	01601	1 71 0 00000	929	CNA		
	01602	1 76 0 00051	930	ADM	BEXP	MODIFY BINARY EXPONENT
	01603	2 75 0 00066	931	LDB	FIVES,X2	POWER OF 5
	01604	0 76 0 00120	932	LDA	Z	
	01605	0 71 0 00120	933	LDX	Z,XO	
	01606	0 6710 056	934	NØD	46	NORMALIZE POWER OF FIVE
*	01607	0 35 0 01422	935	STA	WORD	

01610	1 67 0 00000	936	CXA		
01611	0 6720 011	937	LCY	9	
01612	0 6600 011	938	RSH	9	
01613	1 71 0 00000	939	CNA		
01614	1 76 0 00051	940	ADM	BEXP	BINARY EXPONENT
01615	0 76 0 00017	941	LDA	B1	
01616	0 75 0 00120	942	LDB	Z	
* 01617	1 75 0 01607	943	DIV	WORD	
01620	0 35 0 00055	944	STA	MULT1	1ST WORD OF RECIPRICAL
01621	0 46 10012	945	BAC		
* 01622	1 75 0 01617	946	DIV	WORD	
01623	0 55 0 00066	947	ADD	ONE	
01624	0 35 0 00056	948	STA	MULT2	2ND WORD OF RECIPRICAL
01625	0 43 0 01405	949	BRM	DPNM	DATA TIMES POWER OF 5
01626	0 76 0 00053	950	LDA	DEXP	
01627	1 72 0 00120	951	SKE	Z	TEST FOR DECIMAL SCALING DONE
01630	0 01 0 01566	952	BRU	DPW91	
* 01631	0 76 0 01547	953 DPW10	LDA	WRD1	
5-47 01632	0 53 0 00054	954	SKN	FFLG	TEST FOR FLOATING POINT
01633	0 01 0 01706	955	BRU	DPF	
01634	0 02 20001	956	ROV		
01635	0 71 0 00051	957	LDX	BEXP,X0	
01636	0 53 0 00051	958	SKN	BEXP	
01637	0 01 0 01646	959	BRU	DPW12	
01640	1 77 0 00051	960	XMA	BEXP	
01641	1 71 0 00000	961	CNA		
01642	1 77 0 00051	962	XMA	BEXP	
01643	0 71 0 00051	963	LDX	BEXP,X0	
01644	2 6600 000	964	RSH	0,X2	
01645	0 01 0 01651	965	BRU	DPW13	
01646	2 6700 000	966 DPW12	LSH	0,X2	
01647	0 40 20001	967	OVV		
* 01650	0 61 0 01403	968	MIN	TERR	SET TRUNCATION ERROR
* 01651	0 35 0 01631	969 DPW13	STA	WRD1	
* 01652	0 36 0 01550	970 DPW14	STB	WRD2	
01653	0 43 0 01737	971	BRM	DPSS	COMPLEMENT IF NEG
01654	0 01 0 01730	972	BRU	DPW20	
01655	0 76 0 02102	973 DPW5A	LDA	=22	
01656	1 76 0 00051	974	ADM	BEXP	

01657	0	75	0	00120	975	DPW5	LDB	Z	
01660	0	76	0	00053	976		LDA	DEXP	
01661	0	36	0	00053	977		STB	DEXP	0 TO 8
01662	0	73	0	00031	978		SKG	P9	TEST RANGE
01663	0	01	0	01667	979		BRU	DPW11	
01664	0	54	0	00031	980		SUE	P9	
01665	0	35	0	00053	981		STA	DEXP	
01666	0	76	0	00031	982		LDA	P9	
01667	1	66	0	00000	983	DPW11	CAX		
01670	1	76	0	00051	984		ADM	BEXP	MODIFY BINARY EXPONENT
01671	2	75	0	00066	985		LDB	FIVES,X2	PWER OF 5
01672	0	76	0	00120	986		LDA	Z	
01673	0	71	0	00030	987		LDX	P47,X0	
01674	0	6710	056		988		N0D	46	
01675	0	35	0	00055	989		STA	MULT1	NORMALIZED POWER OF 5
01676	1	67	0	00000	990		CXA		
01677	1	76	0	00051	991		ADM	BEXP	MODIFY B
01700	0	36	0	00056	992		STB	MULT2	CLEAR LOW ORDER WORD
01701	0	43	0	01405	993		BRM	DPNM	DATA TIMES POWER OF 5
01702	0	76	0	00053	994		LDA	DEXP	
01703	0	73	0	00120	995		SKG	Z	
01704	0	01	0	01631	996		BRU	DPW10	FINISHED
01705	0	01	0	01657	997		BRU	DPW5	
01706	0	43	0	01737	998	DPF	BRM	DPSS	COMPLEMENT IF NEG
01707	0	71	0	00030	999		LDX	P47,X0	
01710	0	6710	057		1000		N0D	47	
* 01711	0	35	0	01651	1001		STA	WRD1	
01712	1	67	0	00000	1002		CXA		
01713	0	72	0	00102	1003		SKA	FMM	
01714	0	76	0	00120	1004		LDA	Z	
01715	1	72	0	00120	1005		SKE	Z	
01716	0	55	0	00051	1006		ADD	BEXP	MODIFY BINARY EXPONENT
01717	0	35	0	00051	1007		STA	BEXP	
01720	0	6700	017		1008		LSH	15	
01721	0	6600	017		1009		RSH	15	
01722	1	72	0	00051	1010		SKE	BEXP	
* 01723	0	61	0	01650	1011		MIN	TERR	SET TRUNCATION ERROR
01724	0	6720	017		1012		LCY	15	
01725	1	64	0	00000	1013		CAB		

5-48

01726	0 6620 017	1014	RCY	15	
* 01727	0 36 0 01652	1015	STB	WRD2	
* 01730	0 76 0 01522	1016	DPW20 LDA	CHR	
* 01731	0 35 0 01335	1017	STA	TERM	SET TERMINATIR
* 01732	0 43 0 01537	1018	BRM	GET	SKIP ,
01733	0 43 0 02041	1019	BRM	GNF	
* 01734	0 75 0 01727	1020	LDB	WRD2	
* 01735	0 76 0 01711	1021	LDA	WRD1	
01736	0 51 0 01434	1022	BRR	DPW	EXIT
01737	0 00 0 00000	1023	DPSS HLT	0	
01740	0 53 0 00050	1024	SKN	DPSIGN	TEST DP SIGN
01741	0 51 0 01737	1025	BRR	DPSS	EXIT
01742	0 46 00014	1026	XAB		
* 01743	0 17 0 01520	1027	EOR	M1	
* 01744	0 54 0 01743	1028	SUB	M1	
01745	0 46 00014	1029	XAB		
* 01746	0 55 0 01744	1030	ADD	M1	
* 01747	0 43 0 01474	1031	BRM	SKB	
* 5-49 01750	0 00 0 01746	1032	HLT	M1	
* 01751	0 54 0 01750	1033	SUB	M1	
* 01752	0 17 0 01751	1034	EOR	M1	
* 01753	0 35 0 01735	1035	STA	WRD1	
* 01754	0 36 0 01734	1036	STB	WRD2	
01755	0 51 0 01737	1037	BRR	DPSS	EXIT
01756	0 00 0 00000	1038	\$OCTW HLT	0	
01757	0 43 0 01333	1039	BRM	SSIGN	SET SIGN
01760	0 73 0 00143	1040	SKG	A7	
01761	0 01 0 01764	1041	BRU	OCT1	
* 01762	0 61 0 00666	1042	MIN	EERR	NOT OCTAL CHAR
01763	0 51 0 01756	1043	BRR	OCTW	EXIT
* 01764	0 35 0 01331	1044	OCT1 STA	VALU	
* 01765	0 75 0 00000	1045	LDB	OC	
* 01766	0 43 0 01467	1046	BRM	TCHR	TEST FOR OCTAL CHAR
01767	0 01 0 01776	1047	BRU	OCT2	
01770	0 6600 003	1048	RSH	3	
* 01771	0 76 0 01764	1049	LDA	VALU	
01772	0 72 0 00020	1050	SKA	A0	
* 01773	0 61 0 01723	1051	MIN	TERR	
01774	0 6700 003	1052	LSH	3	INSERT NEW CHAR

	01775	0 01 0	01764	1053	BRU	ØCT1	TRY NEXT CHAR
*	01776	0 35 0	01731	1054	ØCT2	STA	TERM
*	01777	0 43 0	01732	1055		BRM	GET
	02000	0 43 0	02041	1056		BRM	GNF
*	02001	0 76 0	01771	1057		LDA	VALU
	02002	0 17 0	00123	1058		ØØR	ØØ
	02003	0 53 0	00047	1059		SKN	SIGN
	02004	0 17 0	00123	1060		ØØR	ØØ
*	02005	0 35 0	02001	1061		STA	VALU
	02006	0 51 0	01756	1062		BRR	ØCTW
	02007	0 00 0	00000	1063	\$DECW	HLT	Ø
	02010	0 43 0	01333	1064		BRM	SSIGN
	02011	0 73 0	00031	1065		SKG	P9
	02012	0 01 0	02015	1066		BRU	DEC1
	02013	0 76 0	00120	1067		LDA	Z
	02014	0 01 0	02034	1068		BRU	DEC3
*	02015	0 35 0	02005	1069	DEC1	STA	VALU
*	02016	0 75 0	01473	1070		LDB	DC
*	02017	0 43 0	01766	1071		BRM	TCHR
*	02020	0 01 0	02033	1072		BRU	DEC2
*	02021	0 76 0	02015	1073		LDA	VALU
	02022	0 75 0	00120	1074		LDB	Z
	02023	0 02	20001	1075		ØØV	
	02024	0 6700	002	1076		LSH	2
*	02025	0 55 0	02021	1077		ADD	VALU
	02026	0 6700	001	1078		LSH	1
*	02027	0 55 0	01730	1079		ADD	CHR
	02030	0 40	20001	1080		ØVT	
*	02031	0 61 0	01773	1081		MIN	TERR
	02032	0 01 0	02015	1082		BRU	DEC1
*	02033	0 76 0	02025	1083	DEC2	LDA	VALU
	02034	1 71 0	00000	1084	DEC3	CNA	
	02035	0 53 0	00047	1085		SKN	SIGN
	02036	1 71 0	00000	1086		CNA	
*	02037	0 35 0	02033	1087		STA	VALU
	02040	0 51 0	02007	1088		BRR	DECW
	02041	0 00 0	00000	1089	GNF	HLT	Ø
*	02042	0 76 0	01776	1090	GNF1	LDA	TERM
*	02043	1 72 0	00000	1091		SKE	CCHR

*	02044	0 53 0 01752	1092	SKN	M1	ALWAYS SKIP
	02045	0 51 0 02041	1093	BRR	GNF	EXIT
*	02046	1 72 0 01075	1094	SKE	BCHR	TEST FOR BLANK
*	02047	0 53 0 02044	1095	SKN	M1	ALWAYS SKIP
	02050	0 51 0 02041	1096	BRR	GNF	EXIT IF BLANK
*	02051	0 61 0 01762	1097	MIN	EERR	ILLEGAL CHARACTER
*	02052	0 76 0 02027	1098	LDA	CHR	
*	02053	0 35 0 02042	1099	STA	TERM	
*	02054	0 43 0 01777	1100	BRM	GET	SKIP CHARACTER
	02055	0 01 0 02042	1101	BRU	GNF1	
	02056	0 00 0 00000	1102	\$MAXL	HLT	OLD MAX
	02057	0 76 0 00001	1103	LDA	ML0C	
*	02060	0 73 0 00571	1104	SKG	L0C	
*	02061	0 76 0 02060	1105	LDA	L0C	
	02062	0 35 0 00001	1106	STA	ML0C	NEW MAX
	02063	0 51 0 02056	1107	BRR	MAXL	
		00000000	1108	BC0N	EQU	0
		00000100	1109	CC0N	EQU	0100
		00000200	1110	RC0N	EQU	0200
		00003310	1111	SC0N	EQU	03310
		00003411	1112	DC0N	EQU	03411
		00004522	1113	PC0N	EQU	04522
		00004647	1114	QC0N	EQU	04647
			1115		END	
	02064	77770000				BLANK CONNECTER CODE
	02065	00005000				. CONNECTER CODE
	02066	00001700) CONNECTER CODE
	02067	10101010				+ ++ CONNECTER CODES
	02070	00000020				- -- CONNECTER CODES
	02071	00000061				* ** CONNECTER CODES
	02072	00005100				/ // CONNECTER CODES
	02073	00177777				
	02074	00177775				
	02075	00040000				
	02076	00000012				
	02077	37777777				
	02100	00000054				
	02101	77777722				
	02102	00000026				

00014	TPL
00217	LTR1
00016	SOT
02052	CHR
02054	GET
00260	PASS
00223	LTR2
00573	B8
00747	RELM
00575	ADDR
02037	VALU
00766	MODE
00241	LADD
00243	LTR3
00543	VERR
00263	XERR
00265	LRT
02061	L0C
00274	REFM
01747	SK9
00432	IC
00363	LSXT
02053	TERM
00651	PERR
02047	M1
02051	EERR
00533	CNTR
01054	SC
02017	TCHR
00476	DLY1
00503	0CTF
02031	TERR
02046	BCHR
00541	LST
01177	DERR
00673	SCHR
00661	CC
00566	IFLG
00741	RFRR

01174	DUPM
01203	ERR
01210	LIMT
01622	WORD
01754	WRD2
01753	WRD1
02016	DC
01765	CC
02043	CCHR

**SDS PROGRAM LIBRARY
PROGRAM DESCRIPTION**

Page 1 of 7

Catalog No. 012010

IDENTIFICATION: 900 Series SYMBOL Part III

AUTHOR: SDS

ACCEPTED: January 12, 1965

COMPUTER
CONFIGURATION: Any SDS 900 series computer with at least 4K memory.

PURPOSE: Perform input/output editing for SYMBOL.

PROGRAMMED
OPERATORS: CAB, CBA, CAX, CXA, CBX, CNA, SKE, SKR, MUL,
DIV, ADM, XMA

STORAGE: 0725 locations including constants

TIMING: N/A

USE: SYMBOL consists of three parts (separately assembled
programs) plus a mnemonic table plus I/O subroutines.

Part III performs the following functions:

1. Edit the symbolic input line.
2. Edit the listing output image.
3. Set up the binary output record and checksum.
4. Flush the output records.

The following subroutines are documented in the order of
their appearance within SYMBOL Part II.

EDC	
EDE	ELN
EDF	FLD
EDIT	FLDC
EDL	FLUSH

USE: (Cont)

EDR	GET
EDS	OUTP
EDTL	RESET
EDTV	TCHR

EDC Edit character subroutine

Inserts the character in A into the line image. Steps the line image character position. The current position in the line image is specified by:

EXW contains location of current word

EDCX contains current character

Calling sequence:

BRM EDC with character in A return

EDS Edit set

BRM EDS with initialization word in A
return

This subroutine sets the EDC subroutine to put the next character at a particular place. Bits 9 through 23 of A indicate the word position and bits 6 through 7 indicate the character position (0 for first character, etc.).

ELN Edit line number

BRM ELN

return

This subroutine adds one (alphabetically) to the alphabetic line number. The line number is stored in the line number field of the print image.

USE: (Cont)	OUTP	Output
	BRM	OUTP with word in WORD, mode in WMOD
		return
		Put word in output buffer. If buffer or if card type is changed (specified by contents of CTYP) empty buffer first. Uses FLUSH and RESET subroutines.
	FLUSH	Empty punch buffer
	BRM	FLUSH
		return
		Outputs current object record. Uses WRITR subroutine.
	RESET	Reset output buffer
	BRM	RESET
		return
		Initializes output buffer after initially or after buffer has been emptied.
	FLD	Position to next field
	BRM	FLD
		return
		This subroutine skips up to eight blanks. If a non-blank is encountered, the subroutine will exit.
	GET	Get next character
	BRM	GET
		return with next input character in A, X2, and CHR

USE: (Cont)

TCHR Test character

BRM TCHR with character type mask
in Breturn if next character is not of proper
type

return if next character is of proper type

Reads next character. This character is used
as index to mask an entry in CTT (character
translation table) with the contents of B. The
GET subroutine is used.

EDIT Edit form and print subroutine

This subroutine edits the errors, location
and the word in WORD according to the
form in WRD 2 and prints the line image.
The word is also placed in the punch buffer.

The following subroutines are used:

EDS
EDE
EDL
EDR
PRNT
OUTP

Calling sequence:

BRM EDIT

return

EDTV Edit value and print subroutine

This subroutine edits the error flags and
the word in WORD and prints the line
image.

USE: (Cont)

The following subroutines are used:

EDS
EDE
EDF
PRNT

Calling sequence:

BRM EDTV

return

EDTL Edit location and print subroutine

This location edits the error flags and the location counter and prints the line image. The punch buffer is emptied.

The following subroutines are used:

EDE
EDL
PRNT

Calling sequence:

BRM EDTL

return

EDE Edit errors subroutine

The error characters are inserted in the line image if the corresponding flag is set (nonzero). Position is specified in EDWE. ERCC contains minus the number of flags. The flags are reset. The error characters precede ERRC (one character per word). The flags corresponding to the characters precede VERR.

The EDC and EDS subroutines are used.

Calling sequence:

BRM EDE

return

EDL Edit location subroutine

This subroutine edits the location counter.
Position is specified in EDWL.

The subroutines EDF and EDS are used.

Calling sequence:

BRM EDL

return

EDR Edit form reference subroutine

The word in WRD1 is edited according to
the form word given in WRD2 with blanks
inserted between fields and the last word
filled with blanks.

The subroutines EDF, EDC and FLDC are used.

Calling sequence:

BRM EDR

return

EDF Edit field subroutine

Edits the field given in AB. The first
character is in A and the remainder of the
field is left justified in B and the count of
the number of characters in B (if any) is in
CNTR. The number in B is binary and is
edited in octal.

The EDC subroutine is used.

USE: (Cont)

Calling sequence is:

BRM EDF with first character in A,
remainder of field in B

return

FLDC Field count

BRM FLDC with form word in WRD2

return if no more fields

return with field count (in bits) in A and
new form in WRD2.

900 SERIES SYMBOL PART III

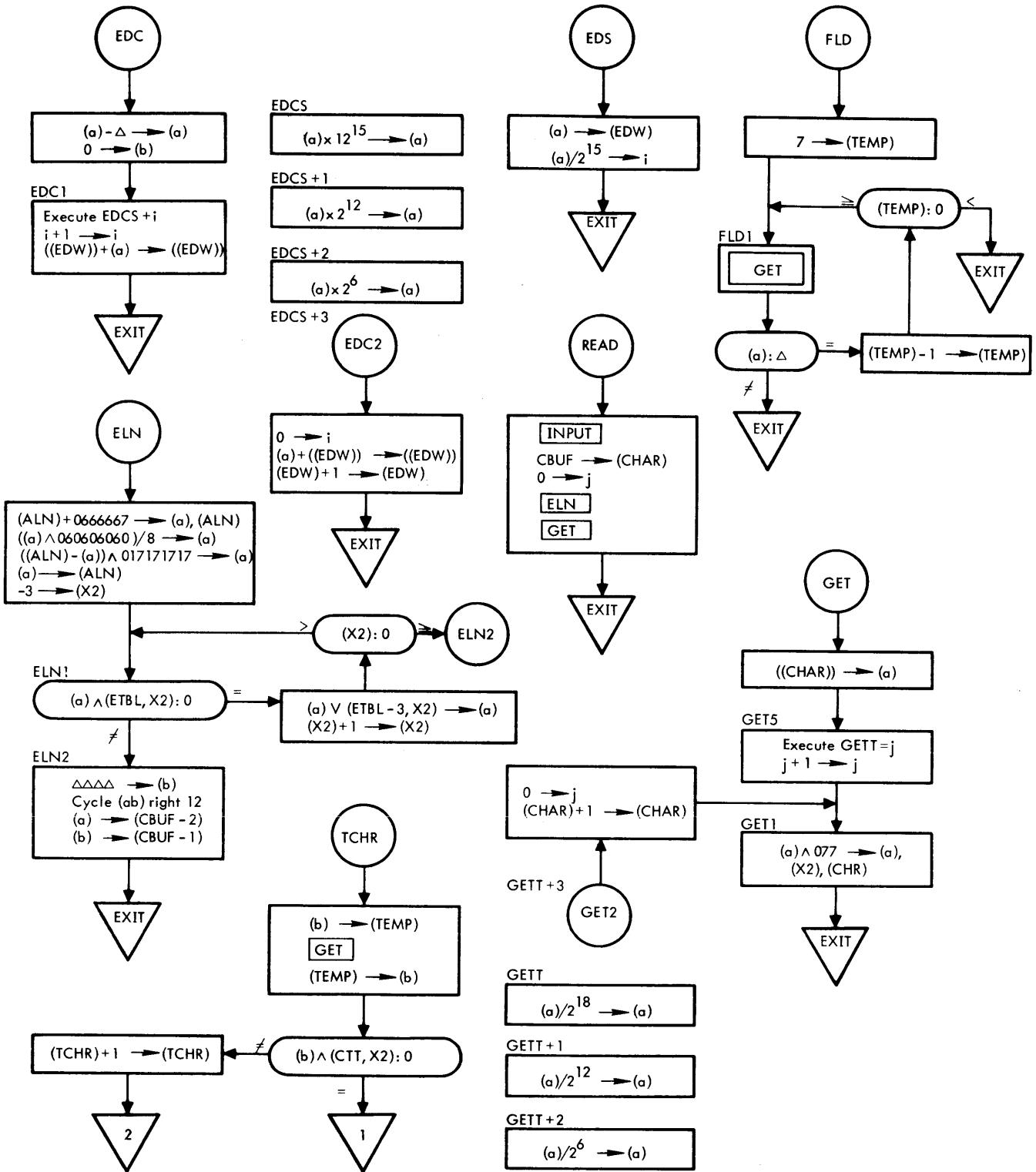

900 SERIES SYMBOL PART III (cont.)

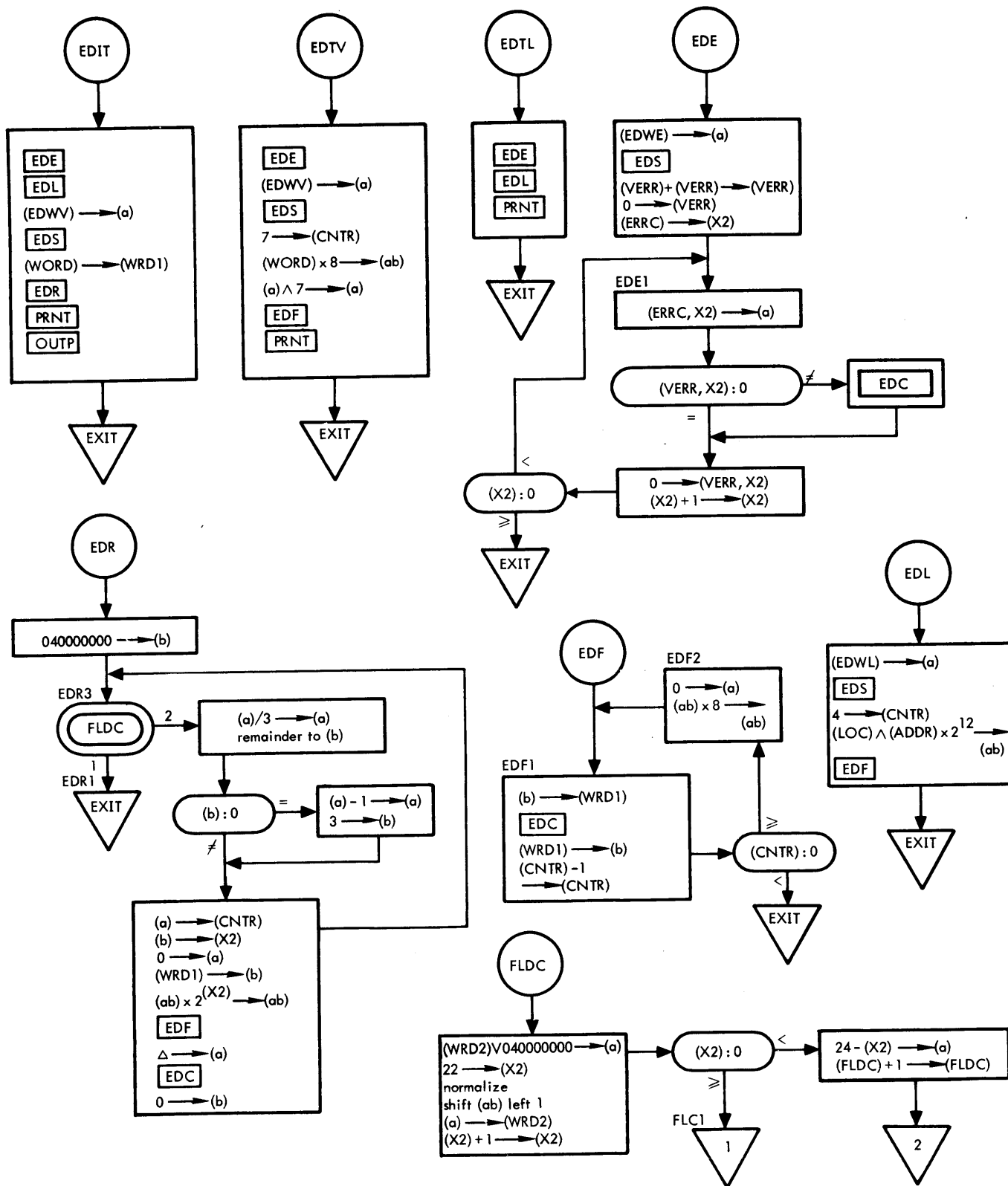

900 SERIES SYMBOL PART III (cont.)

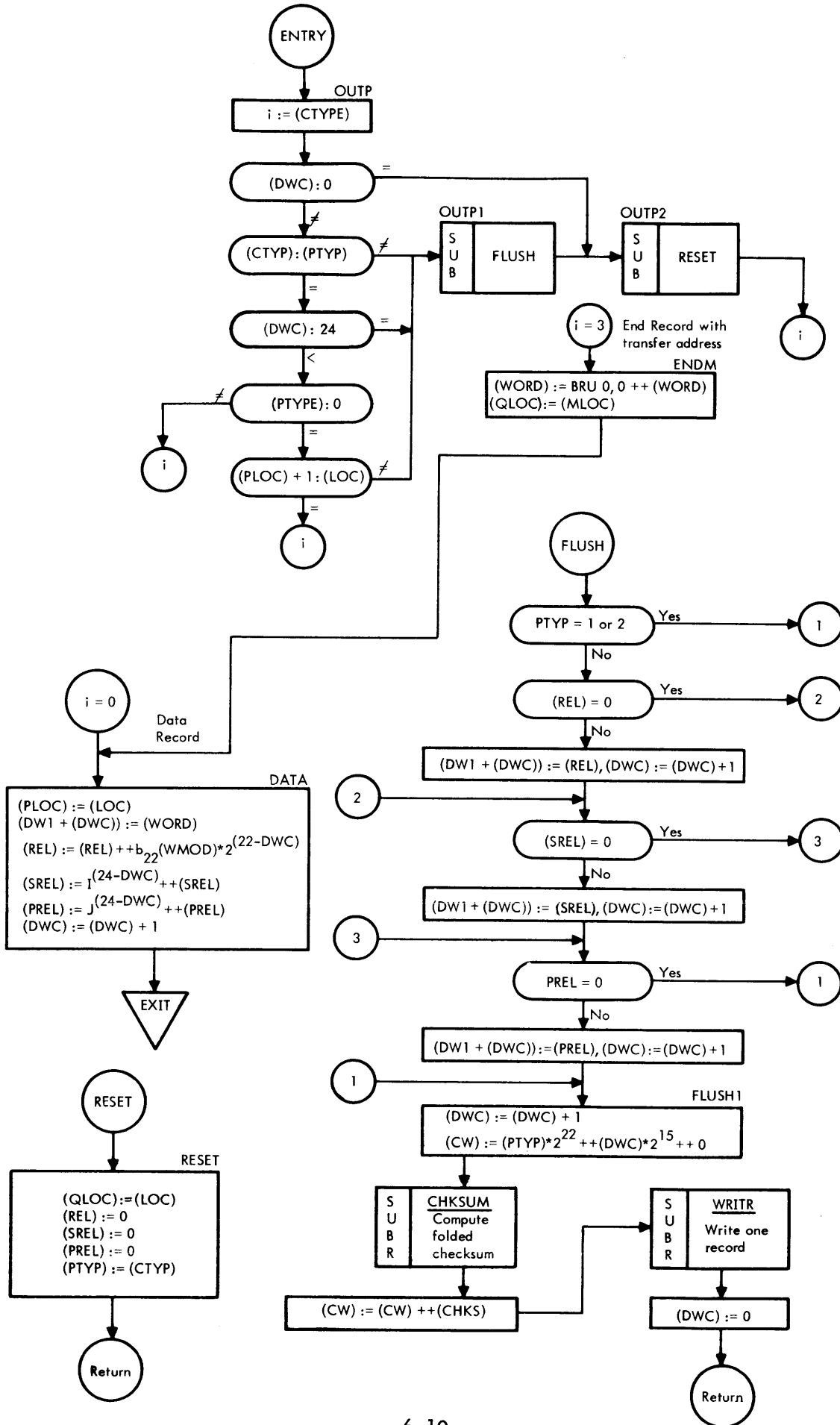

900 SERIES SYMBOL PART III (cont.)

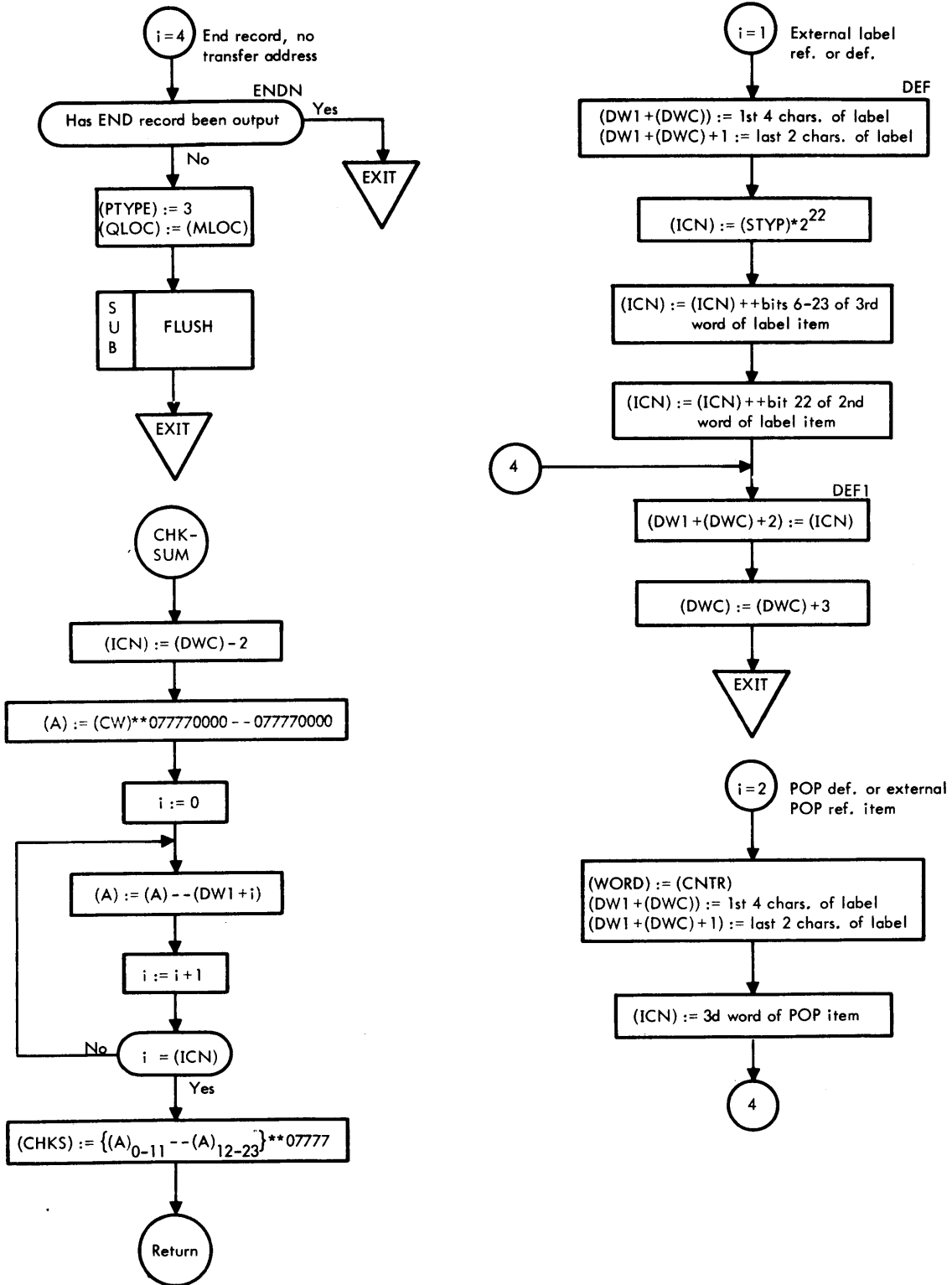

900 SERIES SYMBOL PART III (cont.)

GLOSSARY OF TERMS AND SYMBOLS

- (α) = contents of register whose label is α
- (CTYP) = record type for current data word or symbolic item
- (WORD) = current data word or address of current symbolic item
- (LOC) = location (to be) of (WORD) at object time
- (WMOD)₂₂ = 1 if (WORD) is load relocatable, 0 if not
- (PMOD) = POP reference indicator for (WORD)
 - J = 1 if (PMOD) \neq 0 (means (WORD)₂₋₈ > 77₈)
 - J = 0 if (PMOD) = 0
- (STYP) = if (CTYP) = 0, then (STYP) is special I/O relocation indicator
 - I = 1 if (STYP) < 0
 - I = 0 if (STYP) \geq 0
 if (CTYP) > 0, then (STYP) = item type code (see description of Universal Binary Object Program format)
- (PLOC) = value of (LOC) on previous entry to OUTP
- (DWC) = number of data words in current record
- (MLOC) = 1 + maximum value attained by location counter
- (QLOC) = load address for first word of current data record
- (ICW) = location of current word in current record
- (PTYP) = value of (CTYP) on previous entry to OUTP
- (CHKS) = current checksum value
- (A) = contents of the A register
- (REL) = current load relocation modifier word
- (SREL) = current special I/O relocation modifier word
- (PREL) = current POP relocation modifier word
- (CW) = control word for current record
- (DW1) = 1st data word of current record (DW1 = CW + 1)

Permissible values of (CTYP)

<u>Binary Value</u>	<u>Meaning in OUTP</u>
000	= Data Record item
001	= external (label) reference or definition item
010	= POP definition or external POP reference item
011	= End Record with transfer address
(100	= End Record with no transfer address)*

*Converted to 011 on output.

00000000	1	*	S3	
00000000	2	S9300	EQU	0
00000002	3	X0	EQU	S9300
16400000	4	X2	EQU	2-S9300
16500000	5	CAB	OPD	016400000
16600000	6	CBA	OPD	016500000
16700000	7	GAX	OPD	016600000
17000000	8	CXA	OPD	016700000
17100000	9	GBX	OPD	017000000
17200000	10	GNA	OPD	017100000
17300000	11	SKE	OPD	017200000
17400000	12	SKR	OPD	017300000
17500000	13	MUL	OPD	017400000
17600000	14	DIV	OPD	017500000
17700000	15	ADM	OPD	017600000
	16	XMA	OPD	017700000
	17		AORG	2
	18	\$CW	RES	1
	19	DW1	RES	31
	20		ORG	0
	21	\$CHR	RES	1
	22	\$EDCT	RES	1
	23	\$ALN	RES	1
	24	\$DWC	RES	1
	25	GHAR	RES	1
	26	IFRM	FORM	3,6,1,14
	27	EDWE	HLT	LBUF
	28	EDWL	BRU	LBUF+1
	29	EDWV	HLT	LBUF+3
	30	\$EDW	RES	1
	31	TEMP	RES	1
	32	PTYP	RES	1
	33	PLGC	RES	1
	34	QLGC	RES	1
	35	\$ICW	RES	1
	36	CHKS	RES	1
	37	REL	RES	1
	38	SREL	RES	1

00002
00002
00003
00000
00000
00001
00002
00003
00004

00005 0 00 00022
00006 0 01 00023
00007 0 00 00025

00010
00011
00012
00013
00014
00015
00016
00017
00020

6-13

00021		39	PREL	RES	1
00022		40	\$LBUF	RES	0
00022		41		RES	3
00025		42	\$EREF1	RES	0
00025		43		RES	1
00026		44	\$EREF2	RES	0
00026		45		RES	4
00032		46	\$CBUF	RES	0
00032		47		RES	12
00046		48	\$TBFE	RES	0
00046		49		RES	8
00056		50	\$CBFE	RES	0
00056	60506060	51	\$DLY1	DATA	060606060
00057	00000054	52	ERRA	DATA	054
00060	00000046	53		DATA	*0*
00061	00000024	54		DATA	024
00062	00000025	55		DATA	025
00063	00000031	56		DATA	031
00064	00000043	57		DATA	043
00065	00000047	58		DATA	047
00066	00000051	59		DATA	051
00067	00000053	60		DATA	053
00070	00000064	61		DATA	064
00071	00177766	62	\$ERRC	DATA	ERRA-ERRC+0200000
00072	00000000	63		DATA	060000000
00073	00600000	64		DATA	0600000
00074	00006000	65		DATA	06000
00075	17000000	66		DATA	017000000
00076	00170000	67		DATA	0170000
00077	00001700	68		DATA	01700
00100		69	ETBL	RES	0
00100	0 00 00000	70	\$EDC	HLT	0
00101	0 54 00676	71		SUB	=060
00102	0 75 00000	72		LDB	Z
00103	0 23 00107	73	EDC1	EXU	EDCS
00104	0 61 00103	74		MIN	EDC1
00105	1 76 40010	75		ADM	*EDW
00106	0 51 00100	76		BRR	EDC
00107	0 67 00022	77	EDCS	LSH	18

EXECUTE SHIFT
STEP SHIFT
ADD CHARACTER TO MEMORY
EXIT
1ST CHAR

6-14

*

00110	0	67	00014	78		LSH	12		2ND CHAR
00111	0	67	00006	79		LSH	6		3RD CHAR
00112	0	91	00113	80		BRU	EDC2		LAST CHAR IN WORD
00113	0	75	00120	81	EDC2	LDB	EDCX		RESET EXC
00114	0	36	00103	82		STB	EDC1		
00115	1	76	40010	83		ADM	*EDW		STORE LAST CHAR
00116	0	61	00010	84		MIN	EDW		STEP WORD
00117	0	51	00100	85		BRR	EDC		EXIT
00120	0	23	00107	86	EDCX	EXU	EDCS		
00121	0	00	00000	87	\$EDS	HLT	0		
00122	0	35	00010	88		STA	EDW		WORD POSITION
00123	0	66	00017	89		RSH	15		
00124	0	55	00120	90		ADD	EDCX		
00125	0	35	00103	91		STA	EDC1		CHAR POSITION
00126	0	51	00121	92		BRR	EDS		EXIT
00127	0	00	00000	93	ELN	HLT	0		
00130	0	76	00002	94		LDA	ALN		ALPHABETIC LINE NO.
00131	0	55	00677	95		ADD	=0666667		
00132	0	35	00002	96		STA	ALN		
00133	0	14	00056	97		ETR	DLY1		
00134	0	66	00003	98		RSH	3		
00135	1	71	00000	99		CNA			
00136	0	55	00002	100		ADD	ALN		SUBTRACT ZONE FROM NON-ZONEBITS
00137	0	14	00700	101		ETR	=017171717		
00140	0	35	00002	102		STA	ALN		SAVE ALPHANUMERIC LINE NUMBER
00141	0	71	00701	103		LDX	=00200000-3,X0		
00142	2	72	00100	104	ELN1	SKA	ETBL,X2		TEST FOR 0
00143	0	01	00146	105		BRU	ELN2		
00144	2	16	00075	106		MRG	ETBL-3,X2		REPLACE 0 WITH BLANK
00145	0	41	00142	107		BRX	ELN1,X0		
00146	0	75	00056	108	ELN2	LDB	DLY1		
00147	0	66	20014	109		RCY	12		
00150	0	35	00030	110		STA	CBUF-2		
00151	0	36	00031	111		STB	CBUF-1		
00152	0	51	00127	112		BRR	ELN		EXIT
				113	*				RELOCATABLE BINARY OUTPUT
				114	*				
00153	0	00	00000	115	\$OUTP	HLT	0		
00154	0	71	00000	116		LDX	CTYP,X0		

6-15

Page 3 of 14

LISTING

Catalog No. 012010

	00155	0 76 00003	117	LDA	DWC	
	00156	0 14 00702	118	ETR	=077777	
*	00157	0 73 00102	119	SKG	Z	
	00160	0 01 00200	120	BRU	00TP2	(DWC) = 0, RESET ONLY
	00161	1 67 00000	121	CXA		
	00162	1 72 00012	122	SKE	PTYP	
	00163	0 01 00177	123	BRU	00TP1	TYPE CHANGE, FLUSH AND RESET
	00164	0 76 00703	124	LDA	=24	
	00165	0 73 00003	125	SKG	DWC	
	00166	0 01 00177	126	BRU	00TP1	(DWC) = 24, FLUSH AND RESET
	00167	0 76 00012	127	LDA	PTYP	
*	00170	1 72 00157	128	SKE	Z	
	00171	2 01 40434	129	BRU	*TYP,X2	(PTYP) > 0
	00172	0 76 00013	130	LDA	PL0C	(PTYP) = 0
	00173	0 55 00704	131	ADD	=1	
*	00174	1 72 00000	132	SKE	L0C	
	00175	0 01 00177	133	BRU	00TP1	(PL0C)+1 NOT = (L0C), FLUSH AND RESET
	00176	2 01 40434	134	BRU	*TYP,X2	(PL0C)+1 = (L0C)
	00177	0 43 00241	135	00TP1 BRM	FLUSH	
	00200	0 43 00354	136	00TP2 BRM	RESET	
	00201	2 01 40434	137	BRU	*TYP,X2	
*	00202	0 76 00000	138	ENDM LDA	WORD	
	00203	0 14 00702	139	ETR	=077777	
	00204	0 16 00441	140	MRG	L0RU	
*	00205	0 35 00202	141	STA	WORD	(WORD) := 'BRU 0,0'++(WORD)
*	00206	0 76 00000	142	LDA	ML0C	
	00207	0 35 00014	143	STA	QL0C	(QL0C) := (ML0C)
			144	*		
	00210	0 71 00003	145	DATA LDX	DWC,X0	
*	00211	0 76 00174	146	LDA	L0C	
	00212	0 35 00013	147	STA	PL0C	(PL0C) := (L0C)
*	00213	0 76 00205	148	LDA	WORD	
	00214	2 35 00004	149	STA	DW1+1,X2	(DW1(DWC+1)) := (WORD)
*	00215	0 76 00000	150	LDA	WM0D	
	00216	0 14 00705	151	ETR	=2	
*	00217	0 75 00170	152	LDB	Z	
	00220	2 66 00002	153	RSH	2,X2	B22(WM0D)*2**(22-(DWC))
	00221	1 65 00000	154	CBA		
	00222	0 16 00017	155	MRG	REL	

00223	0	35	00017	156	STA	REL	(REL) := (REL) ++ (A)
00224	0	53	00000	157	SKN	STYP	SKIP IF SPECIAL I/O WORD
00225	0	01	00232	158	BRU	\$+5	
00226	0	75	00704	159	LDB	=1	
00227	0	76	00217	160	LDA	Z	
00230	2	66	20000	161	RCY	0,X2	
00231	1	76	00020	162	ADM	SREL	(SREL) := 1 ** (24 - DWC) ++ (SREL)
00232	0	46	30003	163	CLR		
00233	1	72	00000	164	SKE	PM0D	
00234	0	75	00704	165	LDB	=1	
00235	2	66	20001	166	RCY	1,X2	
00236	1	76	00021	167	ADM	PREL	
00237	0	61	00003	168	MIN	DWC	(DWC) := (DWC) + 1
00240	0	51	00153	169	BRR	0UTP	EXIT
				170			
00241	0	00	00000	171	FLUSH	HLT	ENTRY
00242	0	76	00012	172	LDA	PTYP	RECORD TYPE OF RECORD BEING FLUSHED
00243	0	73	00227	173	SKG	Z	
00244	0	01	00247	174	BRU	\$+3	(PTYP) = 0
00245	1	72	00706	175	SKE	=3	
00246	0	01	00306	176	BRU	FLUSH1	(PTYP) = 1 OR 2
00247	0	61	00003	177	MIN	DWC	INCLUDE LOAD-ADDRESS WORD IN COUNT
00250	0	76	00014	178	LDA	QL0C	
00251	0	35	00003	179	STA	DW1	STORE LOAD ADDRESS
00252	0	71	00003	180	LDX	DWC,X0	
00253	0	76	00017	181	LDA	REL	
00254	1	72	00243	182	SKE	Z	
00255	0	01	00257	183	BRU	\$+2	
00256	0	01	00264	184	BRU	FLSH2	
00257	2	35	00003	185	STA	DW1,X2	STORE RELOCATION INDICATOR WORD
00260	2	77	00001	186	EAX	1,X2	
00261	0	61	00003	187	MIN	DWC	INCLUDE LOAD-RELOCATION WORD IN COUNT
00262	0	76	00707	188	LDA	=02000000	
00263	1	76	00003	189	ADM	DW1	(M) := 1, (RELOCATION WORD PRESENT)
00264	0	76	00020	190	FLSH2	LDA	SREL
00265	1	72	00254	191	SKE	Z	
00266	0	01	00270	192	BRU	\$+2	
00267	0	01	00275	193	BRU	FLSH3	
00270	2	35	00003	194	STA	DW1,X2	

	00271	2	77	00001	195	EAX	1,X2	
	00272	0	61	00003	196	MIN	DWC	INCLUDE SPECIAL RELSC WORD IN COUNT
	00273	0	76	00710	197	LDA	=020000000	
	00274	1	76	00003	198	ADM	DW1	(M) := 8+ (M)
	00275	0	76	00021	199	FLSH3 LDA	PREL	
*	00276	1	72	00265	200	SKE	Z	
	00277	0	01	00301	201	BRU	\$+2	
	00300	0	01	00306	202	BRU	FLUSH1	
	00301	2	35	00003	203	STA	DW1,X2	
	00302	2	77	00001	204	EAX	1,X2	
	00303	0	61	00003	205	MIN	DWC	
	00304	0	76	00711	206	LDA	=010000000	
	00305	1	76	00003	207	ADM	DW1	
					208	*	FORM RECORD CONTROL WORD	
	00306	0	76	00012	209	FLUSH1 LDA	PTYP	RECORD TYPE
*	00307	0	75	00276	210	LDB	Z	
	00310	0	67	00006	211	LSH	6	
	00311	0	55	00704	212	ADD	=1	INCLUDE CONTROL WORD IN COUNT
	00312	0	55	00003	213	ADD	DWC	NR OF WORDS IN RECORD
6-18	00313	0	67	00017	214	LSH	15	
	00314	0	16	00712	215	MRG	=050000	RECORD MODE (BINARY)
	00315	0	35	00002	216	STA	CW	
					217	*	COMPUTE CHECKSUM AND WRITE RECORD	
	00316	0	43	00325	218	BRM	CHKSUM	COMPUTE FOLDED CHECKSUM
	00317	0	16	00002	219	MRG	CW	INSERT CHECKSUM IN CONTROL WORD
	00320	0	35	00002	220	STA	CW	STORE COMPLETED RECORD CONTROL WORD
*	00321	0	43	00000	221	BRM	WRITR	WRITE ONE RECORD
*	00322	0	76	00307	222	LDA	Z	
	00323	0	35	00003	223	STA	DWC	(DWC) := 0
	00324	0	51	00241	224	BRR	FLUSH	EXIT
					225	*		
					226	*	SUBROUTINE TO COMPUTE FOLDED CHECKSUM	
	00325	0	00	00000	227	CHKSUM HLT		ENTRY
	00326	0	76	00002	228	LDA	CW	
	00327	0	66	00017	229	RSH	15	
	00330	0	14	00713	230	ETR	=077	(A) = NR WORDS IN RECORD
	00331	0	54	00705	231	SUB	=2	
	00332	0	35	00353	232	STA	ICN	
	00333	0	76	00706	233	LDA	=DW1	ADDRESS OF 2D WORD

00334	0	35	00015	234	STA	ICW		
00335	0	76	00002	235	LDA	CW		
00336	0	14	00714	236	ETR	=077770000		
00337	0	17	00714	237	EOR	=077770000		
00340	0	17	40015	238	EOR	*ICW		
00341	0	61	00015	239	MIN	ICW		
00342	1	73	00353	240	SKR	ICN		
00343	0	01	00340	241	BRU	\$-3		
00344	0	75	00322	242	LDB	Z		
00345	0	67	20014	243	LCY	12		
00346	0	36	00016	244	STB	CHKS		
00347	0	75	00344	245	LDB	Z		
00350	0	66	20014	246	RCY	12		
00351	0	17	00016	247	EOR	CHKS		
00352	0	51	00325	248	BRR	CHKSUM		
00353	0	00000000		249	ICN	DATA		
				250	*			
				251	*			
				252	*			
6-19	00354	0	00	00000	253	RESET	HLT	
	00355	0	76	00211	254		LDA	L0C
	00356	0	35	00014	255		STA	QL0C
	00357	0	76	00347	256		LDA	Z
	00360	0	35	00017	257		STA	REL
	00361	0	35	00020	258		STA	SREL
	00362	0	35	00021	259		STA	PREL
	00363	0	71	00154	260		LDX	CTYP,XO
	00364	0	37	00012	261		STX	PTYP,XO
	00365	0	51	00354	262		BRR	RESET
				263	*			
	00366	0	76	00357	264	ENDN	LDA	Z
	00367	0	75	00002	265		LDB	CW
	00370	0	67	00003	266		LSH	3
	00371	1	72	00706	267		SKE	=3
	00372	0	01	00374	268		BRU	\$+2
	00373	0	51	00153	269		BRR	0UTP
	00374	0	76	00706	270		LDA	=3
	00375	0	35	00012	271		STA	PTYP
	00376	0	76	00206	272		LDA	ML0C

EXIRACT CHECKSUM
 0DD PARITY CHECKSUM

INCREMENT ADDRESS

(A) = 24-BIT CHECKSUM OF WORDS 1 THRU

(A) = COMPLETED 12-BIT CHECKSUM
 EXIT

ENTRY

(QL0C) := (L0C)

(REL) := 0

(SREL) := 0

EXIT

00377	0	35	00014	273	STA	QL0C	
00400	0	43	00241	274	BRM	FLUSH	
00401	0	51	00153	275	BRR	0UTP	
				276	*		
				277	*		
				278	DEF	LDX	INSERT 3 WORD REF OR DEF ITEM IN CURRENT OUTPUT RECORD
00402	0	71	00003	278		DWC,X0	ENTRY
* 00403	0	76	40213	279	LDA	*WORD	
* 00404	2	35	00003	280	STA	DW1,X2	STORE 1ST 4 CHARS OF LABEL
* 00405	0	61	00403	281	MIN	WORD	
* 00406	0	76	40405	282	LDA	*WORD	
00407	0	14	00714	283	ETR	=077770000	
00410	0	16	00715	284	MRG	=06060	
00411	2	35	00004	285	STA	DW1+1,X2	STORE LAST .2 CHARS OF LABEL
* 00412	0	75	00366	286	LDB	Z	
* 00413	0	76	00224	287	LDA	STYP	
00414	0	67	00026	288	LSH	22	
00415	0	35	00353	289	STA	ICN	
* 00416	0	76	40406	290	LDA	*WORD	
00417	0	14	00705	291	ETR	=2	
* 6-20 00420	0	46	00014	292	XAB		
* 00421	0	61	00416	293	MIN	WORD	
* 00422	0	76	40421	294	LDA	*WORD	
00423	0	14	00702	295	ETR	=077777	
* 00424	0	43	00000	296	BRM	SKB	
00425	0	00	00705	297	HLT	=2	
00426	0	16	00716	298	MRG	=0100000	SET ADDRESS RELOCATION FLAG
00427	0	16	00353	299	MRG	ICN	SET SUB-TYPE
00430	2	35	00005	300	DEF1	STA	DW1+2,X2
00431	0	76	00706	301	LDA	=3	
00432	1	76	00003	302	ADM	DWC	(DWC) := (DWC)+3
00433	0	51	00153	303	BRR	0UTP	EXIT
				304	*		
			00000402	305	REF	EQU	DEF
				306	*		CURRENT RECORD IMAGE
00434	0	00	00210	307	TYP	HLT	DATA
00435	0	00	00402	308		HLT	DEF
00436	0	00	00442	309		HLT	POP
00437	0	00	00202	310		HLT	ENDM
00440	0	00	00366	311		HLT	ENDN

00441	0	01	00000	312	LBRU	BRU	0
00442	0	71	00003	313	P6P	LDX	DWC,X0
00443	0	76	00000	314		LDA	CNTR
00444	0	35	00422	315		STA	WORD
00445	0	76	40444	316		LDA	*WORD
00446	2	35	00003	317		STA	DW1,X2
00447	0	61	00445	318		MIN	WORD
00450	0	76	40447	319		LDA	*WORD
				320			
00451	0	14	00714	321		ETR	=077770000
00452	0	16	00715	322		MRG	=? ?
00453	2	35	00004	323		STA	DW1+1,X2
00454	0	61	00450	324		MIN	WORD
00455	0	76	40454	325		LDA	*WORD
00456	0	01	00430	326		BRU	DEF1
00457	0	00	00000	327	\$READ	HLT	0
00460	0	43	00000	328		BRM	INPUT
00461	0	76	00717	329		LDA	=CBUF
00462	0	35	00004	330		STA	CHAR
6-21 00463	0	76	00521	331		LDA	GETX
00464	0	35	00503	332		STA	GETS
00465	0	43	00127	333		BRM	ELN
00466	0	43	00501	334		BRM	GET
00467	0	51	00457	335		BRR	READ
00470	0	00	00000	336	\$FLD	HLT	0
00471	0	76	00720	337		LDA	=7
00472	0	35	00011	338		STA	TEMP
00473	0	43	00501	339	FLD1	BRM	GET
00474	1	72	00676	340		SKE	=? ?
00475	0	51	00470	341		BRR	FLD
00476	1	73	00011	342		SKR	TEMP
00477	0	01	00473	343		BRU	FLD1
00500	0	51	00470	344		BRR	FLD
00501	0	00	00000	345	\$GET	HLT	0
00502	0	76	40004	346		LDA	*CHAR
00503	0	23	00511	347	GETS	EXU	GETT
00504	0	61	00503	348		MIN	GETS
00505	0	14	00713	349	GET1	ETR	=077
00506	0	35	00000	350		STA	CHR

SET BEGINNING OF LINE

SET BEGINNING OF WORD

GET 1ST CHARACTER OF LINE

EXIT

EXIT

LOAD CHARACTER

EXECUTE SHIFT

00507	1	66	00000	351
00510	0	51	00501	352
00511	0	66	00022	353
00512	0	66	00014	354
00513	0	66	00006	355
00514	0	01	00515	356
00515	0	75	00521	357
00516	0	36	00503	358
00517	0	61	00004	359
00520	0	01	00505	360
00521	0	23	00511	361
00522	0	00	00000	362
00523	0	36	00011	363
00524	0	43	00501	364
00525	0	75	00011	365
00526	0	43	00424	366
00527	2	00	00000	367
00530	0	61	00522	368
00531	0	51	00522	369
00532	0	00	00000	370
00533	0	43	00566	371
00534	0	43	00606	372
00535	0	76	00007	373
00536	0	43	00121	374
00537	0	76	00455	375
00540	0	35	00000	376
00541	0	43	00620	377
00542	0	43	00000	378
00543	0	43	00153	379
00544	0	51	00532	380
00545	0	00	00000	381
00546	0	43	00566	382
00547	0	76	00007	383
00550	0	43	00121	384
00551	0	76	00720	385
00552	0	35	00443	386
00553	0	76	00537	387
00554	0	66	00025	388
00555	0	14	00720	389

	CAX
	BRR
GETT	RSH
	RSH
	RSH
	BRU
GET2	LDB
	STB
	MIN
	BRU
GETX	EXU
STCHR	HLT
	STB
	BRM
	LDB
	BRM
	HLT
	MIN
	BRR
SEDIT	HLT
	BRM
	BRM
	LDA
	BRM
	LDA
	STA
	BRM
	BRM
	BRM
	BRM
	BRM
	BRR
SEDTV	HLT
	BRM
	LDA
	BRM
	LDA
	STA
	LDA
	RSH
	ETR

GET
18
12
6
GET2
GETX
GETS
CHAR
GET1
GETT
0
TEMP
GET
TEMP
SKB
CTT,X2
TCHR
TCHR
0
EDE
EDL
EDWV
EDS
WORD
WRD1
EDR
PRNT
OUTP
EDIT
0
EDE
EDWV
EDS
=7
CNTR
WORD
21
=7

B6

1ST CHAR
2ND CHAR
3RD CHAR
END WORD
RESET EXU
STEP WORD
GET CHAR bits 18-23
TEST FOR MATCH
CHARACTER IS O.K.
EXIT
EDIT ERRORS
EDIT LOCATION
DATA WORD
EDIT BY FORM
PRINT LINE
OUTPUT WORD
EXIT
EDIT ERRORS
VALUE WORD POSITON
7 CHARACTERS LEFT IN B
DATA
LEAVE 1ST CHAR IN A

6-22

Page 19 of 14 LISTING

00556	0	43	00646	390	BRM	EDF	EDIT FIELD
00557	0	43	00542	391	BRM	PRNT	PRINT LINE
00560	0	51	00545	392	BRR	EDTV	EXIT
00561	0	00	00000	393	\$EDTL	HLT	0
00562	0	43	00566	394	BRM	EDE	EDIT ERRORS
00563	0	43	00606	395	BRM	EDL	EDIT LOCATION
00564	0	43	00557	396	BRM	PRNT	PRINT LINE
00565	0	51	00561	397	BRR	EDTL	EXIT
00566	0	00	00000	398	\$EDE	HLT	0
00567	0	76	00005	399	LDA	EDWE	ERROR WORD POSITION
00570	0	43	00121	400	BRM	EDS	
00571	0	76	00412	401	LDA	Z	
00572	1	77	00000	402	XMA	VERR	RESET V ERROR FLAG
00573	1	76	00000	403	ADM	UERR	U SET IF V SET
00574	0	71	00071	404	LDX	ERRC,X0	ERROR COUNT
00575	2	76	00071	405	EDE1	LDA	ERRC,X2
00576	2	75	00572	406	LDB	VERR,X2	ERROR LISTING CHAR
00577	0	43	00526	407	BRM	SKB	
00600	0	00	00000	408	HLT	M1	
00601	0	43	00100	409	BRM	EDC	INSERT ERROR CODE
00602	0	75	00571	410	LDB	Z	
00603	2	36	00576	411	STB	VERR,X2	RESET FLAG
00604	0	41	00575	412	BRX	EDE1,X0	TEST NEXT FLAG
00605	0	51	00566	413	BRR	EDE	EXIT
00606	0	00	00000	414	EDL	HLT	0
00607	0	76	00006	415	LDA	EDWL	LOC WORD POSITION
00610	0	43	00121	416	BRM	EDS	
00611	0	76	00721	417	LDA	=4	
00612	0	35	00552	418	STA	CNTR	4 MORE CHARACTERS IN B
00613	0	76	00355	419	LDA	LOC	
00614	0	14	00000	420	ETR	ADDR	
00615	0	66	00014	421	RSH	12	
00616	0	43	00646	422	BRM	EDF	EDIT LOC
00617	0	51	00606	423	BRR	EDL	EXIT
00620	0	00	00000	424	EDR	HLT	0
00621	0	75	00722	425	LDB	=040000000	
00622	0	43	00660	426	EDR3	BRM	COUNT BITS FIELD
00623	0	01	00645	427	BRU	EDR1	NO MORE FIELDS
00624	0	66	00027	428	RSH	23	

6-23

00625	1	75	00706	429		DIV	=3
00626	0	43	00577	430		BRM	SKB
00627	0	00	00706	431		HLT	=3
00630	0	01	00633	432		BRU	EDR2
00631	0	54	00704	433		SUB	=1
00632	0	75	00706	434		LDB	=3
00633	0	35	00612	435	EDR2	STA	CNTR
00634	1	70	00000	436		CBX	
00635	0	76	00602	437		LDA	Z
00636	0	75	00540	438		LDB	WRD1
00637	2	67	00000	439		LSH	0,X2
00640	0	43	00646	440		BRM	EDF
00641	0	76	00676	441		LDA	=060
00642	0	43	00100	442		BRM	EDC
00643	0	75	00635	443		LDB	Z
00644	0	01	00622	444		BRU	EDR3
00645	0	51	00620	445	EDR1	BRR	EDR
00646	0	00	00000	446	EDF	HLT	0
00647	0	01	00652	447		BRU	EDF1
00650	0	76	00643	448	EDF2	LDA	Z
00651	0	67	00003	449		LSH	3
00652	0	36	00636	450	EDF1	STB	WRD1
00653	0	43	00100	451		BRM	EDC
00654	0	75	00652	452		LDB	WRD1
00655	1	73	00633	453		SKR	CNTR
00656	0	01	00650	454		BRU	EDF2
00657	0	51	00646	455		BRR	EDF
00660	0	00	00000	456	\$FLDC	HLT	0
00661	0	76	00000	457		LDA	WRD2
00662	0	17	00722	458		EOR	=040000000
00663	0	71	00723	459		LDX	=22,X0
00664	0	67	10030	460		NOD	24
00665	0	67	00001	461		LSH	1
00666	0	35	00661	462		STA	WRD2
00667	0	37	00655	463		STX	CNTR,X0
00670	0	76	00724	464		LDA	=23
00671	0	54	00667	465		SUB	CNTR
00672	0	14	00702	466		ETR	=077777
00673	0	73	00703	467		SKG	=24

OCTAL CHARACTERS IN FIELD
BITS IN 1ST CHAR

DATA WORD
1ST CHAR IN A
EDIT FIELD

INSERT TRAILING BLANK

DO NEXT FIELD
EXIT

NEW OCTAL CHAR

INSERT CHAR IN IMAGE

TEST FOR END FIELD

EXIT

FORM WORD

COUNT BITS IN FIELD

NEW FORM WORD

00674	0 61 00660	468		MIN	FLDC	
00675	0 51 00660	469	FLC1	BRR	FLDC	EXIT
		470		END		
00676	00000060					
00677	00666667					
00700	17171717					
00701	00177775					
00702	00077777					
00703	00000030					
00704	00000001					
00705	00000002					
00706	00000003					
00707	02000000					
00710	20000000					
00711	10000000					
00712	00050000					
00713	00000077					
00714	77770000					
00715	00006060					
00716	00100000					
00717	00000032					
00720	00000007					
00721	00000004					
00722	40000000					
00723	00000026					
00724	00000027					
00613	L0C					
00600	M1					
00376	ML0C					
00233	PM0D					
00564	PRNT					
00626	SKB					
00413	STYP					
00573	UERR					
00603	VERR					
00215	WM0D					
00553	W0RD					
00654	WRD1					
00666	WRD2					

6-25

00321 WRTR
00650 Z
00614 ADDR
00671 CNTR
00527 CTT
00363 CTYP
00460 INPUT

6-26

Page 14 of 14

EXPIRING

Caplog No. 012010

**SDS PROGRAM LIBRARY
PROGRAM DESCRIPTION**

Page 1 of 3

Catalog No. 012006

IDENTIFICATION: 900 Series SYMBOL 910 Mnemonic Table

AUTHOR: SDS

ACCEPTED: January 14, 1965

COMPUTER
CONFIGURATION: Any SDS 900 series computer with at least 4,096 words of memory.

PURPOSE: To provide SYMBOL with the mnemonic table of the target machine.

To localize other assembler features which are oriented specifically to the target machine.

PROGRAMMED
OPERATORS: None

STORAGE: 01116 locations

TIMING: N/A

USE: SYMBOL consists of three parts (separately assembled programs) plus a mnemonic table plus I/O subroutines.

By exchanging mnemonic tables, one can assemble SYMBOL programs for the SDS 910, 920, 925, 930 or 9300 on any of these machines.

METHOD: The mnemonic table consists of three-word entries beginning at the location labeled \$MT and ending at the location labeled \$MTE. The format of the mnemonic table is described below.

During pass 1 of the assembly, entries are added to the mnemonic table for all symbol defined on OPD, FORM, or POPD lines. These entries are flagged by bit 18 of the second word in order to permit their being purged in

METHOD: (Cont)

between batched assemblies. Expansion of the mnemonic table as opposed to the building of a separate table allows fast table searching but precludes the use of literals within this portion of the SYMBOL.

For the 910 and 920 mnemonic tables, complete compatibility has been maintained with respect to the SYMBOL 4 mnemonics, with the result that there is some redundancy in the device EOM mnemonics (such as RPTW, RPTY and RPT). Also, certain of the SYMBOL 4 mnemonics are recognized but ignored (such as FORT, LIST, etc.). The user may add to or delete from the SDS - supplied mnemonic table by reassembly.

MNEMONIC TABLE ENTRY FORMAT

<u>Bits</u>	<u>Word</u>	
0-23	1	First four characters of symbol
11	2	Fifth and sixth characters of symbol
12, 20	2	I/O command with unit and channel to be supplied (e. g., RPT)
13	2	Programmed operator
16	2	Not used
17	2	Duplicate flag
18	2	Programmer defined entry (OPD, FORM, POPD or external POP)
19	2	Instruction, octal address
20	2	Instruction, I/O command with channel specified (e. g., RPTW)
21	2	Directive, special label definition
22	2	Directive, normal label definition
23	2	Form

METHOD: (Cont)

If bits 12, 21, 22 and 23 are off, the third word contains the data word without parameters.

The third word of directive entries (bit 21 or 22 on) contains the starting address of the lines of instructions which process the directive line encountered.

The third word of a form item (bit 23 on) contains a form pattern word; i. e., a word with a one in the leading bit position of each field, and zeros elsewhere.

The third word of a programmed operator entry (bit 13) has the following format:

Bits 0-1	Type (0 internal definition, 1 external reference, 2 external definition)
Bits 2-7	Programmed operator number (assigned at end of pass 1)
Bit 8	Relocation bit (if definition)
Bits 9-23	Address of programmed operator interpretive code

		1	*	S5C	
	00000000	2	S9300	EQU	0
	00000000	3	X0	EQU	S9300
	00000002	4	X2	EQU	2-S9300
00000	17600000	5	0176	DATA	017600000
00001	77770000	6	C7777	DATA	077770000
00002	77777776	7	M2	DATA	-2
00003	00002040	8	G2040	DATA	02040
00004	0 61 00000	9	\$P0PR	MIN	PM0D
00005	0 76 00000	10		LDA	WORD
00006	0 14 00000	11		ETR	C176
00007	0 16 00161	12		MRG	B1
00010	0 66 00001	13		RSH	1
00011	0 35 00005	14		STA	WORD
00012	0 61 00000	15		MIN	IERR
00013	0 01 00000	16		BRU	INR1
00014	0 61 00012	17	P0PI	MIN	IERR
		18	\$P0PI		
00015	0 43 00000	19		BRM	DLBL
00016	0 46 30003	20		CLR	
00017	0 35 00011	21		STA	WORD
00020	0 53 00000	22		SKN	PASS
00021	0 01 00023	23		BRU	\$+2
00022	0 01 00013	24		BRU	INR1
00023	0 61 00000	25		MIN	L0C
00024	0 76 00161	26		LDA	B1
00025	0 35 00000	27		STA	LBL1P2
00026	0 71 00000	28		LDX	LSYM,X0
00027	2 76 00000	29		LDA	0,X2
00030	0 35 00000	30		STA	LBL1
00031	2 76 00001	31		LDA	1,X2
00032	0 14 00001	32		ETR	C7777
00033	0 35 00000	33		STA	LBL1P1
00034	0 01 00053	34		BRU	P0PD1
00035	0 53 00020	35	P0PD	SKN	PASS
00036	0 01 00040	36		BRU	\$+2
00037	0 01 00000	37		BRU	FRM4
00040	0 76 00023	38		LDA	L0C

7-4

00041	0	35	00025	39	STA	LBL1P2
00042	0	76	00033	40	LDA	LBL1P1
00043	0	14	00002	41	ETR	M2
00044	0	35	00042	42	STA	LBL1P1
00045	0	76	00172	43	LDA	Z
00046	0	75	00000	44	LDB	M1
00047	0	70	00000	45	SKM	XFLG
00050	0	76	00000	46	LDA	B0
00051	0	55	00041	47	ADD	LBL1P2
00052	0	35	00051	48	STA	LBL1P2
00053	0	76	00003	49	POPD1 LDA	C2040
00054	0	55	00044	50	ADD	LBL1P1
00055	0	35	00054	51	STA	LBL1P1
00056	0	01	00000	52	BRU	CPD1
00057	0	46	30003	53	B00L CLR	
00060	0	35	00000	54	STA	0CTF
00061	0	01	00000	55	BRU	EQU
00062	0	46	30003	56	B0RG CLR	
00063	0	35	00060	57	STA	0CTF
00064	0	01	00000	58	BRU	0RG
00065	0	43	00000	59	0CT BRM	0CTW
00066	0	76	00000	60	LDA	VALU
00067	0	75	00172	61	LDB	Z
00070	0	43	00075	62	BRM	0CTDEC
00071	0	01	00065	63	BRU	0CT
00072	0	43	00000	64	DEC BRM	DPW
00073	0	43	00075	65	BRM	0CTDEC
00074	0	01	00072	66	BRU	DEC
00075	0	00	00000	67	0CTDEC HLT	0
00076	0	53	00035	68	SKN	PASS
00077	0	01	00112	69	BRU	0D1
00100	0	36	00017	70	STB	WORD
00101	0	54	00046	71	SUB	M1
00102	0	72	00101	72	SKA	M1
00103	0	01	00105	73	BRU	\$+2
00104	0	53	00100	74	SKN	WORD
00105	0	55	00102	75	ADD	M1
00106	0	35	00104	76	STA	WORD
00107	0	76	00050	77	LDA	B0

7-5

*	00110	0 35 00000	78		STA	WRD2
*	00111	0 43 00000	79		BRM	EDIT
*	00112	0 61 00040	80	BD1	MIN	L0C
*	00113	0 76 00000	81		LDA	TERM
*	00114	0 75 00105	82		LDB	M1
*	00115	0 70 00163	83		SKM	CCHR
*	00116	0 01 00000	84		BRU	LINE
*	00117	0 51 00075	85		BRR	0CTDEC
*	00120	0 76 00000	86	BCI	LDA	P14
*	00121	0 75 00000	87		LDB	DC
*	00122	0 71 00000	88		LDX	CHR,X0
*	00123	0 43 00000	89		BRM	SKB
*	00124	2 00 00000	90		HLT	CIT,X2
*	00125	0 43 00000	91		BRM	DECW
*	00126	0 75 00000	92		LDB	SPAC
*	00127	0 36 00000	93		STB	BC1F
*	00130	0 67 00002	94		LSH	2
*	00131	0 01 00000	95		BRU	TEXT1
*	00132	0 53 00076	96	BPT	SKN	PASS
*	00133	0 01 00000	97		BRU	LIN2
7-6	00134	0 76 00160	98		LDA	SKSB
*	00135	0 35 00106	99		STA	WORD
*	00136	0 43 00000	100	BPT1	BRM	SCAN
*	00137	0 76 00161	101		LDA	B1
*	00140	0 71 00066	102		LDX	VALU,X0
*	00141	2 66 00015	103		RSH	13,X2
*	00142	0 14 00162	104		ETR	BPM
*	00143	0 73 00172	105		SKG	Z
*	00144	0 61 00000	106		MIN	TERR
*	00145	0 55 00135	107		ADD	WORD
*	00146	0 35 00145	108		STA	WORD
*	00147	0 76 00113	109		LDA	TERM
*	00150	0 75 00114	110		LDB	M1
*	00151	0 70 00163	111		SKM	CCHR
*	00152	0 01 00000	112		BRU	LIN3
*	00153	0 01 00136	113		BRU	BPT1
*	00154	00600000	114	SE0D	DATA	0600000
*	00155	00200000	115	SE0M	DATA	0200000
*	00156	04600000	116	SSKSE0D	DATA	04600000

IGNORE IF 1ST PASS

INSTRUCTION
GET BREAK-POINT

POSITION BREAKPOINT BIT
MASK
TEST RANGE
SET TRUNCATION ERROR

LAST BREAKPOINT
GET NEXT BREAKPOINT

00157	00640000	117	\$E0DI	DATA	0640000
00160	04020000	118	SKSB	DATA	04020000
00161	20000000	119	B1	DATA	020000000
00162	00000740	120	BPM	DATA	0740
00163	00000073	121	CCHR	DATA	073
00164	0 20 00000	122	\$DPWR	N0P	0
00165	44040000	123	\$INST	DATA	044040000
00166	00040000	124	\$INDB	DATA	040000
00167	00000016	125	\$AB	DATA	016
00170	00000011	126	\$NAB	DATA	9
00171	0 00 37777	127	\$ADDR	HLT	037777
00172		128	\$FORCES	RES	0
00172	00000000	129	Z	DATA	0
00173	00000007	130	\$XMSK	DATA	07
	00000020	131	INS1	EQU	020
	00000010	132	INS2	EQU	010
	00004010	133	INS9	EQU	04010
	00000004	134	DIR1	EQU	4
	00000002	135	DIR2	EQU	2
	060600000	136	NEM	0PD	060600000
		137	HAF	FORM	12.12
		138	P	FORM	9.15
00174		139	\$MT	RES	0
00174	43237060	140		TEXT	4.LCY
00175	6 06 00000	141		NEM	0
00176	06720000	142		DATA	006720000
00177	43242160	143		TEXT	4.LDA
00200	6 06 00000	144		NEM	0
00201	07600000	145		DATA	007600000
00202	43242260	146		TEXT	4.LDB
00203	6 06 00000	147		NEM	0
00204	07500000	148		DATA	007500000
00205	43246760	149		TEXT	4.LDX
00206	6 06 00000	150		NEM	0
00207	07100000	151		DATA	007100000
00210	43314360	152		TEXT	4.LIL
00211	6 06 00002	153		NEM	DIR2
00212	0 00 00000	154		HLT	N0P0
00213	43316263	155		TEXT	4.LIST

FLPT EXCHANGE OPERATOR. XAB FOR 9300

7-7

00214	6 06 00002	156	NEM	DIR2
00215	0 00 00212	157	HLT	N0P0
00216	43623060	158	TEXT	4,LSH
00217	6 06 00000	159	NEM	0
00220	06700000	160	DATA	006700000
00221	44242560	161	TEXT	4,MDE
00222	6 06 00000	162	NEM	0
00223	06000000	163	DATA	06000000
00224	44314560	164	TEXT	4,MIN
00225	6 06 00000	165	NEM	0
00226	06100000	166	DATA	006100000
00227	44316660	167	TEXT	4,MIW
00230	6 06 00000	168	NEM	0
00231	01200000	169	DATA	001200000
00232	44317060	170	TEXT	4,MIY
00233	6 06 00000	171	NEM	0
00234	01000000	172	DATA	001000000
00235	44512760	173	TEXT	4,MRG
00236	6 06 00000	174	NEM	0
00237	01600000	175	DATA	001600000
00240	44646260	176	TEXT	4,MUS
00241	6 06 00000	177	NEM	0
00242	06400000	178	DATA	06400000
00243	45462460	179	TEXT	4,N0D
00244	6 06 00000	180	NEM	0
00245	06710000	181	DATA	006710000
00246	45464760	182	TEXT	4,N0P
00247	6 06 00000	183	NEM	0
00250	02000000	184	DATA	002000000
00251	46236360	185	TEXT	4,0CT
00252	6 06 00002	186	NEM	DIR2
00253	0 00 00065	187	HLT	0CT
00254	46472460	188	TEXT	4,0PD
00255	6 06 00004	189	NEM	DIR1
00256	0 00 00000	190	HLT	0PD
00257	46512760	191	TEXT	4,0RG
00260	6 06 00004	192	NEM	DIR1
00261	0 00 00064	193	HLT	0RG
00262	46656360	194	TEXT	4,0VT

7-8

00263	5 06 00000	195	NEM	0
00264	04020001	196	DATA	04020001
00265	47212725	197	TEXT	4,PAGE
00266	6 06 00002	198	NEM	DIR2
00267	0 00 00000	199	HLT	PAGE
00270	47226360	200	TEXT	4,PBT
00271	6 06 04010	201	NEM	INS9
00272	04012045	202	DATA	04012045
00273	47232260	203	TEXT	4,PCB
00274	6 06 04010	204	NEM	INS9
00275	0 02 03045	205	EOM	003045
00276	47232460	206	TEXT	4,PCD
00277	6 06 04010	207	NEM	INS9
00300	0 02 02045	208	EOM	002045
00301	47314560	209	TEXT	4,PIN
00302	6 06 00000	210	NEM	0
00303	03300000	211	DATA	003300000
00304	47464724	212	TEXT	4,P0PD
00305	6 06 00004	213	NEM	DIR1
00306	0 00 00035	214	HLT	P0PD
00307	47466360	215	TEXT	4,P0T
00310	6 06 00000	216	NEM	0
00311	01300000	217	DATA	001300000
00312	47476360	218	TEXT	4,PPT
00313	6 06 04010	219	NEM	INS9
00314	0 02 02043	220	EOM	02043
00315	47476366	221	TEXT	4,PPTW
00316	6 06 00010	222	NEM	INS2
00317	00202043	223	DATA	00202043
00320	47476370	224	TEXT	4,PPTY
00321	6 06 00010	225	NEM	INS2
00322	00202143	226	DATA	00202143
00323	47634360	227	TEXT	4,PTL
00324	6 06 04010	228	NEM	INS9
00325	0 02 00043	229	EOM	043
00326	47634366	230	TEXT	4,PTLW
00327	6 06 00010	231	NEM	INS2
00330	00200043	232	DATA	00200043
00331	47634370	233	TEXT	4,PTLY

7-9

7-10

00332	6 06 00010	234	NEM	INS2
00333	00200143	235	DATA	00200143
00334	47712560	236	TEXT	4,PZE
00335	6 06 00002	237	NEM	DIR2
00336	0 00 00000	238	HLT	PZE
00337	51232260	239	TEXT	4,RCB
00340	6 06 04010	240	NEM	INS9
00341	0 02 03005	241	EOM	03005
00342	51232266	242	TEXT	4,RCBW
00343	6 06 00010	243	NEM	INS2
00344	00203005	244	DATA	00203005
00345	51232270	245	TEXT	4,RCBY
00346	6 06 00010	246	NEM	INS2
00347	00203105	247	DATA	00203105
00350	51232460	248	TEXT	4,RCD
00351	6 06 04010	249	NEM	INS9
00352	0 02 02005	250	EOM	02005
00353	51232466	251	TEXT	4,RCDW
00354	6 06 00010	252	NEM	INS2
00355	00202005	253	DATA	00202005
00356	51232470	254	TEXT	4,RCDY
00357	6 06 00010	255	NEM	INS2
00360	00202105	256	DATA	00202105
00361	51233060	257	TEXT	4,RCH
00362	6 06 00020	258	NEM	INS1
00363	04600000	259	DATA	004600000
00364	51237060	260	TEXT	4,RCY
00365	6 06 00000	261	NEM	0
00366	06620000	262	DATA	006620000
00367	51254360	263	TEXT	4,REL
00370	6 06 00002	264	NEM	DIR2
00371	0 00 00215	265	HLT	N0P0
00372	51256260	266	TEXT	4,RES
00373	6 06 00002	267	NEM	DIR2
00374	0 00 00000	268	HLT	BSS
00375	51256660	269	TEXT	4,REW
00376	6 06 04010	270	NEM	INS9
00377	0 02 14010	271	EOM	014010
00400	51256666	272	TEXT	4,REWW

00401	6 06 00010	273	NEM	INS2
00402	0 02 14010	274	EOM	014010
00403	51422260	275	TEXT	4,RKB
00404	6 06 04010	276	NEM	INS9
00405	0 02 02000	277	EOM	02000
00406	51422266	278	TEXT	4,RKBW
00407	6 06 00010	279	NEM	INS2
00410	00202000	280	DATA	00202000
00411	51422270	281	TEXT	4,RKBY
00412	6 06 00010	282	NEM	INS2
00413	00202100	283	DATA	00202100
00414	51455127	284	TEXT	4,RORG
00415	6 06 00002	285	NEM	DIR2
00416	0 00 00261	286	HLT	ORG
00417	51466560	287	TEXT	4,R0V
00420	6 06 00000	288	NEM	0
00421	0 02 20001	289	EOM	020001
00422	51476360	290	TEXT	4,RPT
00423	6 06 04010	291	NEM	INS9
00424	0 02 02003	292	EOM	02003
00425	51476366	293	TEXT	4,RPTW
00426	6 06 00010	294	NEM	INS2
00427	00202003	295	DATA	00202003
00430	51476370	296	TEXT	4,RPTY
00431	6 06 00010	297	NEM	INS2
00432	00202103	298	DATA	00202103
00433	51623060	299	TEXT	4,RSH
00434	6 06 00000	300	NEM	0
00435	06600000	301	DATA	006600000
00436	51632260	302	TEXT	4,RTB
00437	6 06 04010	303	NEM	INS9
00440	0 02 03010	304	EOM	03010
00441	51632266	305	TEXT	4,RTBW
00442	6 06 00010	306	NEM	INS2
00443	00203010	307	DATA	00203010
00444	51632270	308	TEXT	4,RTBY
00445	6 06 00010	309	NEM	INS2
00446	00203110	310	DATA	00203110
00447	51632460	311	TEXT	4,RTD

7-11

Page 8 of 17

LISTING

Catalog No. 01/2006

00450	6 06 04010	312
00451	J 02 02010	313
00452	51632466	314
00453	6 06 00010	315
00454	00202010	316
00455	51632470	317
00456	6 06 00010	318
00457	00202110	319
00460	51636260	320
00461	6 06 04010	321
00462	0 02 14000	322
00463	62262260	323
00464	6 06 04010	324
00465	0 02 03030	325
00466	62262266	326
00467	6 06 00010	327
00470	00203030	328
00471	62262460	329
00472	6 06 04010	330
00473	0 02 02030	331
00474	62422160	332
00475	6 06 00000	333
00476	07200000	334
00477	62422760	335
00500	6 06 00000	336
00501	07300000	337
00502	62424460	338
00503	6 06 00000	339
00504	07000000	340
00505	62424560	341
00506	6 06 00000	342
00507	05300000	343
00510	62426260	344
00511	6 06 00020	345
00512	04000000	346
00513	62512260	347
00514	6 06 04010	348
00515	0 02 07030	349
00516	62512266	350

NEM	INS9
EOM	02010
TEXT	4,RTDW
NEM	INS2
DATA	00202010
TEXT	4,RTDY
NEM	INS2
DATA	00202110
TEXT	4,RTS
NEM	INS9
EOM	014000
TEXT	4,SFB
NEM	INS9
EOM	03030
TEXT	4,SFBW
NEM	INS2
DATA	00203030
TEXT	4,SFD
NEM	INS9
EOM	02030
TEXT	4,SKA
NEM	0
DATA	007200000
TEXT	4,SKG
NEM	0
DATA	007300000
TEXT	4,SKM
NEM	0
DATA	007000000
TEXT	4,SKN
NEM	0
DATA	005300000
TEXT	4,SKS
NEM	INS1
DATA	004000000
TEXT	4,SRB
NEM	INS9
EOM	07030
TEXT	4,SRBW

00517	6 06 00010	351	NEM	INS2
00520	00207030	352	DATA	00207030
00521	62512360	353	TEXT	4,SRC
00522	6 06 04010	354	NEM	INS9
00523	0 02 12005	355	EOM	012005
00524	62512460	356	TEXT	4,SRD
00525	6 06 04010	357	NEM	INS9
00526	0 02 06030	358	EOM	06030
00527	62632160	359	TEXT	4,STA
00530	6 06 00000	360	NEM	0
00531	03500000	361	DATA	003500000
00532	62632260	362	TEXT	4,STB
00533	6 06 00000	363	NEM	0
00534	03600000	364	DATA	003600000
00535	62636760	365	TEXT	4,STX
00536	6 06 00000	366	NEM	0
00537	03700000	367	DATA	003700000
00540	62642260	368	TEXT	4,SUB
00541	6 06 00000	369	NEM	0
00542	05400000	370	DATA	005400000
00543	63232460	371	TEXT	4,TCD
00544	6 06 00002	372	NEM	DIR2
00545	0 00 00371	373	HLT	NOP0
00546	63256763	374	TEXT	4,TEXT
00547	6 06 00002	375	NEM	DIR2
00550	0 00 00000	376	HLT	TEXT
00551	63464760	377	TEXT	4,T0P
00552	6 06 04010	378	NEM	INS9
00553	0 02 14000	379	EOM	014000
00554	63464766	380	TEXT	4,T0PW
00555	5 06 00000	381	NEM	0
00556	0 02 14000	382	EOM	014000
00557	63464770	383	TEXT	4,T0PY
00560	5 06 00000	384	NEM	0
00561	0 02 14100	385	EOM	014100
00562	63516360	386	TEXT	4,TRT
00563	6 06 04010	387	NEM	INS9
00564	04010410	388	DATA	04010410
00565	63704760	389	TEXT	4,TYP

00566	6 06 04010	390
00567	0 02 02040	391
00570	53704766	392
00571	6 06 00010	393
00572	00202040	394
00573	63704770	395
00574	6 06 00010	396
00575	00202140	397
00576	64454331	398
00577	6263 0002	399
00600	0 00 00545	400
00601	66314460	401
00602	6 06 00000	402
00603	03200000	403
00604	56632260	404
00605	6 06 04010	405
00606	0 02 03050	406
00607	66632266	407
00610	6 06 00010	408
00611	00203050	409
00612	56632270	410
00613	6 06 00010	411
00614	00203150	412
00615	66632460	413
00616	6 06 04010	414
00617	0 02 03150	415
00620	66632466	416
00621	6 06 00010	417
00622	00202050	418
00623	66632470	419
00624	6 06 00010	420
00625	00202150	421
00626	67212260	422
00627	6 06 00000	423
00630	04600014	424
00631	70314460	425
00632	6 06 00000	426
00633	03000000	427
00634	21222360	428

NEM	INS9
EOM	02040
TEXT	4,TYPW
NEM	INS2
DATA	00202040
TEXT	4,TYPY
NEM	INS2
DATA	00202140
TEXT	4,UNLI
HAF	*ST*,DIR2
HLT	N8P8
TEXT	4,WIM
NEM	0
DATA	003200000
TEXT	4,WTB
NEM	INS9
EOM	03050
TEXT	4,WTBW
NEM	INS2
DATA	00203050
TEXT	4,WTBY
NEM	INS2
DATA	00203150
TEXT	4,WTD
NEM	INS9
EOM	02050
TEXT	4,WTDW
NEM	INS2
DATA	00202050
TEXT	4,WDY
NEM	INS2
DATA	00202150
TEXT	4,XAB
NEM	0
DATA	004600014
TEXT	4,YIM
NEM	0
DATA	003000000
TEXT	4,ABC

7-14

00635	6 06 00000	429	NEM	0
00636	04620005	430	DATA	04620005
00637	21242460	431	TEXT	4,ADD
00640	6 06 00000	432	NEM	0
00641	05500000	433	DATA	05500000
00642	21315160	434	TEXT	4,AIR
00643	6 06 00000	435	NEM	0
00644	0 02 20020	436	EOM	020020
00645	21432360	437	TEXT	4,ALC
00646	6 06 04010	438	NEM	INS9
00647	00250000	439	DATA	0250000
00650	21465127	440	TEXT	4,AORG
00651	6 06 00004	441	NEM	DIR1
00652	0 00 00000	442	HLT	AORG
00653	21622360	443	TEXT	4,ASC
00654	6 06 04010	444	NEM	INS9
00655	0 02 12000	445	EOM	012000
00656	22212360	446	TEXT	4,BAC
00657	6 06 00000	447	NEM	0
00660	04610012	448	DATA	04610012
00661	22232460	449	TEXT	4,BCD
00662	6 06 00002	450	NEM	DIR2
00663	0 00 00000	451	HLT	BCD
00664	22233160	452	TEXT	4,BCI
00665	6 06 00002	453	NEM	DIR2
00666	0 00 00120	454	HLT	BCI
00667	22256366	455	TEXT	4,BETW
00670	6 06 00000	456	NEM	0
00671	04020010	457	DATA	04020010
00672	22256370	458	TEXT	4,BETY
00673	6 06 00000	459	NEM	0
00674	04020020	460	DATA	04020020
00675	22434260	461	TEXT	4,BLK
00676	6 06 00002	462	NEM	DIR2
00677	0 00 00600	463	HLT	NOP0
00700	22464643	464	TEXT	4,B00L
00701	6 06 00004	465	NEM	DIR1
00702	0 00 00057	466	HLT	B00L
00703	22465127	467	TEXT	4,B0RG

7-15

00704	6 06 00004	468	NEM	DIR1
00705	0 00 00062	469	HLT	BORG
00706	22476360	470	TEXT	4,BPT
00707	6 06 00002	471	NEM	DIR2
00710	0 00 00132	472	HLT	BPT
00711	22514460	473	TEXT	4,BRM
00712	6 06 00000	474	NEM	0
00713	04300000	475	DATA	04300000
00714	22515160	476	TEXT	4,BRR
00715	5 06 00000	477	NEM	0
00716	05100000	478	DATA	05100000
00717	22516366	479	TEXT	4,BRTW
00720	5 06 00000	480	NEM	0
00721	04021000	481	DATA	04021000
00722	22516370	482	TEXT	4,BRTY
00723	6 06 00000	483	NEM	0
00724	04022000	484	DATA	04022000
00725	22516460	485	TEXT	4,BRU
00726	6 06 00000	486	NEM	0
00727	0 01 00000	487	BRU	0
00730	22516760	488	TEXT	4,BRX
00731	6 06 00000	489	NEM	0
00732	04100000	490	DATA	04100000
00733	22626260	491	TEXT	4,BSS
00734	6 06 00002	492	NEM	DIR2
00735	0 00 00374	493	HLT	BSS
00736	22636360	494	TEXT	4,BTT
00737	5 06 04010	495	NEM	INS9
00740	04012010	496	DATA	04012010
00741	23216360	497	TEXT	4,CAT
00742	6 06 04010	498	NEM	INS9
00743	04014000	499	DATA	04014000
00744	23256360	500	TEXT	4,CET
00745	6 06 04010	501	NEM	INS9
00746	04011000	502	DATA	04011000
00747	23266360	503	TEXT	4,CFT
00750	6 06 04010	504	NEM	INS9
00751	04011005	505	DATA	04011005
00752	23316360	506	TEXT	4,CIT

7-16

00753	6 06 04010	507	NEM	INS9
00754	04010400	508	DATA	04010400
00755	23435160	509	TEXT	4,CLR
00756	6 06 00000	510	NEM	0
00757	04630003	511	DATA	04630003
00760	23476360	512	TEXT	4,CPT
00761	6 06 04010	513	NEM	INS9
00762	04014045	514	DATA	04014045
00763	23516360	515	TEXT	4,CRT
00764	6 06 04010	516	NEM	INS9
00765	04012005	517	DATA	04012005
00766	23716360	518	TEXT	4,CZT
00767	6 06 04010	519	NEM	INS9
00770	04012000	520	DATA	04012000
00771	24216321	521	TEXT	4,DATA
00772	6 06 00002	522	NEM	DIR2
00773	0 00 00000	523	HLT	DATA
00774	24252360	524	TEXT	4,DEC
00775	6 06 00002	525	NEM	DIR2
00776	0 00 00072	526	HLT	DEC
00777	24252460	527	TEXT	4,DED
01000	6 06 00002	528	NEM	DIR2
01001	0 00 00000	529	HLT	DED
01002	24315160	530	TEXT	4,DIR
01003	6 06 00000	531	NEM	0
01004	0 02 20004	532	DIR	
01005	24316260	533	TEXT	4,DIS
01006	6 06 00000	534	NEM	0
01007	06500000	535	DATA	06500000
01010	24316266	536	TEXT	4,DISW
01011	6 06 00000	537	NEM	0
01012	0 02 00000	538	EOM	0
01013	24316270	539	TEXT	4,DISY
01014	6 06 00000	540	NEM	0
01015	0 02 00100	541	EOM	0100
01016	24622360	542	TEXT	4,DSC
01017	6 06 04010	543	NEM	INS9
01020	0 02 00000	544	EOM	0
01021	25216760	545	TEXT	4,EAX

7-17

7-18

01022	6 06 00000	546	NEM	0
01023	07700000	547	DATA	07700000
01024	25266360	548	TEXT	4,EFT
01025	6 06 04010	549	NEM	INS9
01026	0 02 03070	550	EOM	03070
01027	25315160	551	TEXT	4,EIR
01030	6 06 00000	552	NEM	0
01031	0 02 20002	553	EIR	
01032	25452460	554	TEXT	4,END
01033	6 06 00002	555	NEM	DIR2
01034	0 00 00000	556	HLT	END
01035	25462460	557	TEXT	4,EOD
01036	6 06 00020	558	NEM	INS1
01037	00600000	559	DATA	0600000
01040	25464460	560	TEXT	4,EOM
01041	6 06 00020	561	NEM	INS1
01042	00200000	562	DATA	0200000
01043	25465160	563	TEXT	4,EOR
01044	6 06 00000	564	NEM	0
01045	01700000	565	DATA	01700000
01046	25506460	566	TEXT	4,EQU
01047	6 06 00004	567	NEM	DIR1
01050	0 00 00061	568	HLT	EQU
01051	25516360	569	TEXT	4,ERT
01052	6 06 04010	570	NEM	INS9
01053	0 02 07070	571	EOM	07070
01054	25635160	572	TEXT	4,ETR
01055	6 06 00000	573	NEM	0
01056	01400000	574	DATA	01400000
01057	25636360	575	TEXT	4,ETT
01060	6 06 04010	576	NEM	INS9
01061	04011010	577	DATA	04011010
01062	25636660	578	TEXT	4,ETW
01063	5 06 00010	579	NEM	INS2
01064	00203070	580	DATA	00203070
01065	25676460	581	TEXT	4,EXU
01066	6 06 00000	582	NEM	0
01067	02300000	583	DATA	02300000
01070	26236360	584	TEXT	4,FCT

01071	6 06 04010	585	NEM	INS9
01072	04014005	586	DATA	04014005
01073	26465144	587	TEXT	4,F0RM
01074	6 06 00004	588	NEM	DIR1
01075	0 00 00000	589	HLT	F0RM
01076	26465163	590	TEXT	4,F0RT
01077	6 06 00002	591	NEM	DIR2
01100	0 00 00677	592	HLT	N0P0
01101	26476360	593	TEXT	4,FPT
01102	6 06 04010	594	NEM	INS9
01103	04014010	595	DATA	04014010
01104	30436360	596	TEXT	4,HLT
01105	6 06 00000	597	NEM	0
01106	00000000	598	DATA	0
01107	31246360	599	TEXT	4,IDT
01110	6 06 00000	600	NEM	0
01111	04020004	601	DATA	04020004
01112	31256360	602	TEXT	4,IET
01113	6 06 00000	603	NEM	0
01114	04020002	604	DATA	04020002
01115		605	RES	1
	00000001	606	END	1
00055	LBL1P1			
00052	LBL1P2			
00030	LBL1			
00133	LIN2			
00152	LIN3			
00116	LINE			
00112	L0C			
00026	LSYM			
00150	M1			
01100	N0P0			
00063	0CTF			
00065	0CTW			
00056	0PD1			
00256	0PD			
00416	0RG			
00120	P14			
00267	PAGE			

\$MTE

00132 PASS
00004 PM9D
00336 PZE
00136 SCAN
00123 SKB
00126 SPAC
00147 TERM
00144 TERR
00550 TEXT
00131 TEXT1
00140 VALU
00146 WORD
00110 WRD2
00047 XFLG
00652 AORG
00107 30
00663 BCD
00127 BCIF
00735 BSS
00122 CHR
00124 CTF
00773 DATA
00121 DC
00125 DECW
01001 DED
00015 DL9L
00072 DPW
00111 EDIT
01034 END
01050 EQU
01075 FORM
00037 FRM4
00014 IERR
00022 INR1

7-20

INDEX OF ROUTINES

<u>Routine</u>	<u>Section</u>	<u>Page</u>	<u>Routine</u>	<u>Section</u>	<u>Page</u>
AORG	Part I	4-7	EDIT	Part III	6-9
BCI	Part I	4-9	EDL	Part III	6-9
BGN	Part I	4-3	EDR	Part III	6-9
BOOL	920 Mnemonic Table	7-27	EDS	Part III	6-8
BORG	920 Mnemonic Table	7-27	EDTL	Part III	6-9
BPT	920 Mnemonic Table	7-25	EDTV	Part III	6-9
BSS	Part I	4-7	ELN	Part III	6-8
			END	Part I	4-10
			EOU	Part I	4-6
CAD	Part II	5-12			
CAP	Part II	5-12	FLD	Part III	6-8
CAS	Part II	5-12	FLDC	Part III	6-9
CBS	Part II	5-13	FLUSH	Part III	6-10
CDS	Part II	5-12	FORM	Part I	4-7
CEQ	Part II	5-12	FREF	Part I	4-12
CHKSUM	Part II	6-11			
CLD	Part II	5-12	GET	Part III	6-8
CLP	Part II	5-12	GNF	Part II	5-22
CLS	Part II	5-12			
CNVRT	Part II	5-19	INR1	Part I	4-5
COPY	920 Mnemonic Table	7-26			
	9300 Mnemonic Table	7-53	LOAD	Loader	2-8
COPYE	920 Mnemonic Table	7-26	LINE	Part I	4-4
CXQ	Part II	5-12	LXL	Part I	4-6
DATA	Part I	4-8	MAXL	Part II	5-22
DEC	920 Mnemonic Table	2-27	MOVE	Part II	5-18
DECW	Part II	5-22			
DED	Part I	4-8	NSRT	Part II	5-17
DGNB	Part I	4-3			
DLBL	Part I	4-6	OCT	920 Mnemonic Table	7-27
DPA	Part II	5-19	OCTDEC	920 Mnemonic Table	7-27
DPMT	Part II	5-19	OCTW	Part II	5-22
DPNM	Part II	5-19	OPD	Part I	4-7
DPSS	Part II	5-22	ORG	Part I	4-7
DPW	Part II	5-20	OUTP	Part III	6-10
DRF	Part II	5-21			
			PAGE	Part I	4-7
EDC	Part III	6-8	PLTR	Part I	4-11
EDC2	Part III	6-8	POPD	920 Mnemonic Table	7-24
EDE	Part III	6-9	POPI	920 Mnemonic Table	7-24
EDF	Part III	6-9	POPR	920 Mnemonic Table	7-24

INDEX OF ROUTINES (cont.)

<u>Routine</u>	<u>Section</u>	<u>Page</u>	<u>Routine</u>	<u>Section</u>	<u>Page</u>
READ	Loader	2-7	SCNM	Part II	5-10
	Part III	6-7	SCNR	Part II	5-10
RESET	Part III	6-9	SCO	Part II	5-13
			SCS	Part II	5-13
SCA	Part II	5-14	SCX	Part II	5-14
SCAN	Part II	5-11	SRCH	Part II	5-17
SCC	Part II	5-15	SSING	Part II	5-19
SCD	Part II	5-13	STRT	Loader	2-5
SCI	Part II	5-13	SYM	Part II	5-16
SCIT	Part II	5-13			
SCL	Part II	5-14	TCHR	Part III	6-7
SCNL	Part II	5-10	TEXT	Part I	4-9

**SDS PROGRAM LIBRARY
PROGRAM DESCRIPTION**

Page 1 of 3

Catalog No. 012014

IDENTIFICATION: SYMBOL Reproduce and Update Routine

AUTHOR: Ken Brown, SDS

ACCEPTED: April 16, 1965

COMPUTER
CONFIGURATION: Any 900 series computer.

PURPOSE: To edit a binary paper tape consisting of multiple Standard Binary programs. Editing is performed at the file level.

PROGRAMMED
OPERATORS: None

STORAGE: 666

TIMING: N/A

SOURCE
LANGUAGE: SYMBOL

LOADING
PROCEDURE: Standard Fill Procedure

USE: The program is designed to copy or skip a number of files (standard binary programs) on paper tape as specified by typewriter inputs. These inputs are as follows:

1. **ΔCOPY BOOT.** (Main use is to up-date paper tape version of SYMBOL) This will cause the Bootstrap Loader, Pre-loader, and Loader to be copied. If breakpoint 2 is set, only the Bootstrap Loader and Pre-loader will be copied.
2. **ΔCOPY n FILES.** ($0 < n \leq 89$)
Will copy n files (standard binary programs) as specified. Labels of External Definition Items and External Programmed Operator Definitions of those files copied will be typed.

- USE: (Cont.)
3. **ΔCOPY** name 1 THRU name 2
Name 1 and name 2 are labels from one to eight alphanumeric characters which must be contained in a type 1 or type 2 record. The tape will be searched until the first label is found. The file containing that label (name 1) will be reproduced as will the following files up to an including the file containing name 2.
 4. **ΔSKIP** n FILES. ($0 < n \leq 89$)
Will skip n files.

Typewriter Inputs:

Any typewriter inputs preceeding the "Δ" will be ignored. A period or carriage return is used as a terminator. A typewriter input message may be deleted by typing /.

Example: To replace the third file on a SYMBOL System Tape.

With System tape on photo reader type:

1. **ΔCOPY** BOOT.
(Copies Boot, Pre-loader, and Loader)
2. **ΔCOPY** 2 FILES
(Copies 2 files, printing the labels of the External Definition Items)
3. Place file to be inserted in photo reader and type:
ΔCOPY 1 FILE
4. Replace system tape in photo reader and type:
ΔSKIP 1 FILE
(Skips the file being replaced)
5. **ΔCOPY** n FILES
(n is the remaining number of files on the system tape.)

Example: To replace LOG on 920 POP Tape:

Place POP Tape in photo reader and type:

1. **ΔCOPY** BDD THRU DIB.
(POP Tape will be copied from BDD through DIB with labels typed out.)

- USE: (Cont.)
2. Place new LOG routine in photo reader and type:
 Δ COPY 1 FILE.
 (This will copy new LOG routine.)
 3. Place POP tape back in reader and type:
 Δ SKIP 1 FILE.
 Δ COPY n FILES.
 (n is the remaining files on the POP Tape.)

Note: If the number of files on a tape to be copied is unknown, a number larger than the actual number of files on the tape may be used. In this case, the tape being copied will spin off its reel after all files have been copied.

Example: Δ COPY 75 FILES.

Error Messages:

1. COPY INSTRUCTION NOT FOUND

Cause: 1. First word following " Δ " is not a "COPY" or a "SKIP".

2. A space follows the " Δ ".

2. RECORD NOT IN SYMBOL FORMAT.

Cause: Record type is not a 0, 1, 2, or 3.

3. RECORD NOT IN BINARY FORMAT.

Cause: Last record read was not in Standard Binary format.

4. ILLEGAL BOOT FORMAT ON TAPE READ

Cause: First record read after "COPY BOOT" type-in is not a standard bootstrap loader.

00001				1	AORG	01	
00001	0	01	0	00200	2	BRU	0200
00200				3	AORG	0200	
00200	0	76	0	01335	4	BEGIN LDA	REPLACE INSTRUCTION WHICH
00201	0	35	0	01171	5	STA	HAS BEEN MODIFIED
00202	0	71	0	01321	6	LDX	
00203	0	76	0	01230	7	LDA	REINITIALIZE STORAGE LOCATIONS
00204	2	35	0	01245	8	STA	AND INSTRUCTIONS WHICH HAVE
00205	0	41	0	00204	9	BRX	BEEN MODIFIED
00206	0	76	0	01334	10	LDA	
00207	0	35	0	00360	11	STA	
00210	0	76	0	01336	12	LDA	
00211	0	35	0	00633	13	STA	
00212	0	35	0	01022	14	STA	
00213	0	35	0	01047	15	STA	
00214	0	35	0	01131	16	STA	
00215	0	71	0	01316	17	LDX	
00216	0	76	0	01331	18	LDA	
00217	2	35	0	01263	19	STA	
00220	0	41	0	00217	20	BRX	END OF REINITIALIZATION
00221	0	43	0	00777	21	BRM	
00222	0	02	0	02001	22	RKBW	
00223	0	32	0	01231	23	WIM	
00224	0	75	0	01307	24	LDB	
00225	0	76	0	01231	25	LDA	
00226	0	70	0	01323	26	SKM	HAS CONTROL CHARACTER BEEN TYPED
00227	0	01	0	00223	27	BRU	
00230	0	71	0	01315	28	LDX	YES --- BEGIN EDIT OF KEY-INS
00231	0	02	0	02001	29	TYPE RKBW	
00232	0	32	0	01231	30	WIM	
00233	0	75	0	01307	31	LDB	00000077
00234	0	76	0	01231	32	LDA	
00235	0	70	0	01310	33	SKM	00000012
00236	0	01	0	00240	34	BRU	
00237	0	01	0	00253	35	BRU	PACK WORD AND GET NEXT CHARACTER
00240	0	70	0	01311	36	SKM	00000033
00241	0	01	0	00243	37	BRU	
00242	0	01	0	00264	38	BRU	TERMINATE INPUT MESSAGE

00243	0 70 0 01312	39	SKM	CARET	00000052
00244	0 01 0 00246	40	BRU	\$+2	
00245	0 01 0 00264	41	BRU	ENDIN	
00246	0 70 0 01313	42	SKM	KYERR	DELETE KEY-IN
00247	0 01 0 00251	43	BRU	\$+2	
00250	0 01 0 00335	44	BRU	DELETE	
00251	2 35 0 01255	45	STA	NAME1+4,2	
00252	0 41 0 00232	46	BRX	TYPE+1	NO - BRANCH IF<4 CHARACTERS KEYED IN
00253	0 43 0 01153	47	NXCAR BRM	WORDX	GO TO ROUTINE TO PACK 4CHAR/WORD
00254	0 75 0 01307	48	LDB	CHMSK	
00255	0 32 0 01231	49	WIM	CHBUF	
00256	0 76 0 01231	50	LDA	CHBUF	ONE CHARACTER BUFFER
00257	0 70 0 01310	51	SKM	BLANK	
00260	0 01 0 00262	52	BRU	\$+2	CHARACTER NOT A BLANK - ACCEPT IT
00261	0 01 0 00255	53	BRU	\$-1	
00262	0 71 0 01315	54	LDX	M4	
00263	0 01 0 00236	55	BRU	TYPE+5	
00264	0 02 00000	56	ENDIN DISW		INPUT TERMINATOR HAS BEEN TYPED
00265	0 43 0 01140	57	BRM	CR	
00266	0 43 0 01153	58	BRM	WORDX	
00267	0 75 0 01342	59	LDB	SEVENS	
00270	0 76 0 01255	60	LDA	FIRST	INITIAL WORD KEYED IN
00271	0 70 0 01357	61	SKM	SKIP	
00272	0 01 0 00274	62	BRU	\$+2	DO NOT SKIP FILES
00273	0 01 0 00731	63	BRU	SKPRC	GO TO ROUTINE TO SKIP FILES
00274	0 70 0 01356	64	SKM	COPY	
00275	0 01 0 01211	65	BRU	CTERR	ILLEGAL INSTRUCTION
00276	0 76 0 01256	66	LDA	FIRST+1	CHECK SECOND WORD INPUT
00277	0 70 0 01355	67	SKM	BOOT	IS BOOT COPY DESIRED
00300	0 01 0 00302	68	BRU	\$+2	
00301	0 01 0 00430	69	BRU	BOOT1	YES - GO TO BOOT COPY ROUTINE
00302	0 43 0 00606	70	BRM	SEPRC	NOT BOOT - CHECK COPY PARAMETERS
00303	0 43 0 00305	71	BRM	STCNT	NO INPUT PARAMETERS SET UP FILE CNT.
00304	0 01 0 00340	72	BRU	RDPTE	
00305	0 00 00000	73	STCNT PZE	0	ROUTINE TO CONVERT DECIMAL INPUTS
00306	0 75 0 01342	74	LDB	SEVENS	TO OCTAL NUMBER
00307	0 76 0 01257	75	LDA	FIRST+2	
00310	0 70 0 01361	76	SKM	FILE	INSURE THAT KEYIN IS LEGAL
00311	0 01 0 01201	77	BRU	NOTYP	INPUT IS OBVIOUSLY FOULED UP

00312	0 75 0 01417	78	LDB	=0770000	
00313	0 76 0 01256	79	LDA	FIRST+1	WORD CONTAINING BCD VALUE OF N FILES
00314	0 70 0 01420	80	SKM	=0600000	UNITS OR TENS COUNT
00315	0 01 0 00317	81	BRU	\$+2	TENS
00316	0 01 0 00330	82	BRU	DIGIT	UNITS
00317	0 6720 002	83	LCY	2	
00320	0 75 0 01230	84	LDB	ZER0	
00321	0 6620 024	85	RCY	20	TENS INTO A REG -- UNITS IN
00322	0 35 0 01233	86	STA	XT0TEN	
00323	0 71 0 01233	87	LDX	XT0TEN	
00324	0 76 0 01230	88	LDA	ZER0	
00325	0 6720 006	89	LCY	6	BRING UNITS INTO A REG
00326	2 55 0 01344	90	ADD	TENS,2	ADD TENS COLUMN
00327	0 01 0 00332	91	BRU	\$+3	
00330	0 75 0 01230	92	DIGIT LDB	ZER0	
00331	0 6620 022	93	RCY	13	UNITS COLUMN ONLY
00332	0 35 0 01256	94	STA	FIRST+1	OCTAL EQUIVALENT OF DECIMAL INPUT
00333	0 60 0 01256	95	SKR	FIRST+1	
00334	0 51 0 00305	96	BRR	STCNT	
00335	0 02 00000	97	DELETE DISW		IGNORE KEY-INS - RESTART
00336	0 43 0 01140	98	BRM	CR	
00337	0 01 0 00200	99	BRU	BEGIN	
00340	0 76 0 01230	100	RDPTTE LDA	ZER0	
00341	0 35 0 01241	101	STA	N0REC	
00342	0 43 0 00777	102	BRM	BUFTS	
00343	0 76 0 01421	103	LDA	=02000	STARTING ADDRESS OF TAPE INPUT BUFFER
00344	0 35 0 01225	104	STA	STRGE	
00345	0 02 0 02604	105	RPTW	1,4	
00346	0 32 1 01225	106	WIM	*STRGE	
00347	0 61 0 01226	107	MIN	CONST	WORD COUNT
00350	0 61 0 01225	108	MIN	STRGE	
00351	0 40 21000	109	BRTW		
00352	0 01 0 00346	110	BRU	\$-4	
00353	0 02 00000	111	DISW		
00354	0 60 0 01226	112	SKR	CONST	ADJUST FOR FREE WIM
00355	0 60 0 01225	113	SKR	STRGE	
00356	0 43 0 00761	114	BRM	CKE0F	
00357	0 76 0 01226	115	CHTK0 LDA	CONST	
00360	0 35 0 01263	116	STA	REF1	NUMBER OF WORDS IN THIS RECORD

00361	0 61 0	00360	117	MIN	\$-1	SET ADDRESS TO STORE WRDS IN NXT RECD
00362	0 61 0	01241	118	MIN	NOREC	KEEP COUNT OF TYPE 1 AND 2 RECORDS
00363	0 76 0	01225	119	LDA	STRGE	
00364	0 54 0	01226	120	SUB	CONST	
00365	0 35 0	01235	121	STA	RADR	ADDRESS OF FIRST WORD OF TAPE RECORD
00366	0 43 0	00502	122	BRM	CKZER0	BRM TO CHECK RECORD TYPE
00367	0 76 0	01230	123	LDA	ZER0	
00370	0 35 0	01226	124	STA	CONST	
00371	0 01 0	00345	125	BRU	RDPT+5	LAST RECORD WAS TYPE 1 OR 2 REPEAT
00372	0 00	00000	126	PNCH PZE	0	
00373	0 43 0	00777	127	BRM	BUFTS	
00374	0 61 0	01241	128	MIN	NOREC	ADJUST RECORD COUNT FOR FIRST PASS
00375	0 71 0	01422	129	LDX	=040000	
00376	0 60 0	01241	130	SKR	NOREC	
00377	0 76 0	01241	131	LDA	NOREC	
00400	0 75 0	01342	132	LDB	SEVENS	
00401	0 70 0	01230	133	SKM	ZER0	IF NOREC=0, ALL RECORDS HAVE BEEN
00402	0 01 0	00406	134	BRU	AGAIN	PUNCHED - IF NOT, PUNCH NEXT RECORD
00403	0 76 0	01334	135	LDA	RESET	RESTORE MODIFIED INSTRUCTION
00404	0 35 0	00360	136	STA	CHTK0+1	
00405	0 51 0	00372	137	BRR	PNCH	
00406	0 76 0	00360	138	AGAIN LDA	CHTK0+1	
00407	0 54 0	01241	139	SUB	NOREC	
00410	0 35 0	01240	140	STA	TEMP	
00411	0 76 1	01240	141	LDA	*TEMP	NUMBER OF WORDS IN THIS RECORD
00412	0 35 0	01226	142	STA	CONST	
00413	0 02 0	00644	143	PTLW	1,4	
00414	0 60 0	01226	144	LOOP SKR	CONST	
00415	0 20 0	00000	145	N0P		
00416	0 53 0	01226	146	SKN	CONST	SKIP IF COMPLETE RECORD HAS BEEN PNCH
00417	0 01 0	00421	147	BRU	\$+2	
00420	0 01 0	00423	148	BRU	\$+3	
00421	2 12 0	02000	149	MIW	02000,2	
00422	0 41 0	00414	150	BRX	LOOP	
00423	0 02	14000	151	T0PW		
00424	0 76 0	01230	152	LDA	ZER0	
00425	0 35 0	01226	153	STA	CONST	
00426	0 43 0	00777	154	BRM	BUFTS	
00427	0 01 0	00376	155	BRU	PNCH+4	PUNCH ANOTHER RECORD

00430	0	76	0	01421	156	BOOT1	LDA	=02000	
00431	0	35	0	01225	157		STA	STRGE	
00432	0	02	0	02604	158		RPTW	1,4	READ BOOT ONL
00433	0	32	1	01225	159		WIM	*STRGE	
00434	0	61	0	01226	160		MIN	CNST	
00435	0	61	0	01225	161		MIN	STRGE	
00436	0	40		21000	162		BRTW		
00437	0	01	0	00433	163		BRU	\$-4	
00440	0	02		00000	164		DISW		BOOTSTRAP HAS BEEN READ
00441	0	60	0	01226	165		SKR	CNST	
00442	0	76	0	02000	166		LDA	02000	FIRST WORD OF BOOTSTRAP
00443	0	75	0	01342	167		LDB	SEVENS	
00444	0	70	0	01343	168		SKM	WIM3	CHECK FOR LEGAL BOOTSTRAP 03200003
00445	0	01	0	00447	169		BRU	\$+2	ILLEGAL BOOT
00446	0	01	0	00460	170		BRU	PNHBT	
00447	0	43	0	00777	171		BRM	BUFTS	
00450	0	71	0	01320	172		LDX	M9	
00451	0	02	0	02641	173		TYPW	1,4	TYPE ILLEGAL BOOT MESSAGE
00452	2	12	0	01401	174		MIW	MSG2+8,2	
00453	0	41	0	00452	175		BRX	\$-1	
00454	0	02		14000	176		TOPW		
00455	0	43	0	00777	177		BRM	BUFTS	
00456	0	43	0	01140	178		BRM	CR	
00457	0	01	0	00200	179		BRU	BEGIN	
00460	0	43	0	00777	180	PNHBT	BRM	BUFTS	
00461	0	71	0	01422	181		LDX	=040000	
00462	0	02	0	00644	182		PTLW	1,4	PUNCH BOOT RECORD ONLY
00463	0	60	0	01226	183	LOOP1	SKR	CNST	
00464	0	20	0	00000	184		NBP		
00465	0	53	0	01226	185		SKN	CNST	
00466	0	01	0	00470	186		BRU	\$+2	
00467	0	01	0	00472	187		BRU	\$+3	
00470	2	12	0	02000	188		MIW	02000,2	
00471	0	41	0	00463	189		BRX	LOOP1	
00472	0	02		14000	190		TOPW		
00473	0	76	0	01230	191		LDA	ZERO	
00474	0	35	0	01226	192		STA	CNST	
00475	0	40		20200	193		BPT	2	IS LOADER WANTED
00476	0	01	0	00500	194		BRU	\$+2	NO PUNCH BOOT AND PRE-LOADER ONLY

00477	0 76 0 01423	195	LDA	=01	
00500	0 35 0 01256	196	STA	FIRST+1	SET TO PUNCH PRE-LOADER + LOADER
00501	0 01 0 00340	197	BRU	RDPT2	
00502	0 00 00000	198	CKZERO PZE	0	
00503	0 76 1 01235	199	LDA	*RADR	FIRST WORD OF RECORD JUST READ
00504	0 75 0 01325	200	LDB	TYPMSK	
00505	0 70 0 01246	201	SKM	RTYPE+1	TYPE1
00506	0 01 0 00510	202	BRU	\$+2	
00507	0 51 0 00502	203	BRU	CKZERS	
00510	0 70 0 01247	204	SKM	RTYPE+2	TYPE2
00511	0 01 0 00513	205	BRU	\$+2	
00512	0 51 0 00502	206	BRU	CKZERO	
00513	0 70 0 01250	207	SKM	RTYPE+3	
00514	0 01 0 00516	208	BRU	\$+2	
00515	0 01 0 00520	209	BRU	\$+3	
00516	0 70 0 01245	210	SKM	RTYPE	TYPE 0 DATA RECORD
00517	0 01 0 01201	211	BRU	NOTYP	
00520	0 53 0 01224	212	SKN	FLAG1	
00521	0 01 0 00523	213	BRU	\$+2	
00522	0 43 0 00676	214	BRM	CKLAST	
00523	0 53 0 01224	215	SKN	FLAG1	
00524	0 53 0 01223	216	SKN	FLAG	IF SET - PARAMETERS ARE NEEDED
00525	0 01 0 00527	217	BRU	\$+2	
00526	0 43 0 00633	218	BRM	CKINP	
00527	0 43 0 01032	219	BRM	LBLCK1	
00530	0 43 0 01003	220	BRM	CKRIN	TEST FOR BINARY RECORDS
00531	0 43 0 00372	221	BRM	PNCH	RECORDS ARE OK - PUNCH THEM
00532	0 43 0 00534	222	BRM	RDPT2	READ REMAINING BLOCKS ON RECORD
00533	0 01 0 00200	223	BRU	BEGIN	
00534	0 00 00000	224	RDPT2 PZE	0	
00535	0 76 0 01421	225	LDA	=02000	ROUTINE TO PUNCH BY BLOCKS
00536	0 35 0 01225	226	STA	STRGE	
00537	0 43 0 00777	227	BRM	BUFTS	
00540	0 02 0 02604	228	RPTW	1,4	
00541	0 32 1 01225	229	WIM	*STRGE	
00542	0 61 0 01226	230	MIN	CONST	
00543	0 61 0 01225	231	MIN	STRGE	
00544	0 40 21000	232	BRTW		
00545	0 01 0 00541	233	BRU	\$-4	

00546	0 02 00000	234	DISW		
00547	0 60 0 01226	235	SKR	C9NST	ADJUST FOR FREE WIM
00550	0 76 0 02000	236	LDA	02000	
00551	0 75 0 01424	237	LDB	=070000	
00552	0 70 0 01322	238	SKM	BINRY	SI RECORD BINARY
00553	0 01 0 00717	239	BRU	NTBIN	NO-ILLEGAL FORMAT
00554	0 43 0 00777	240	BRM	BUFTS	
00555	0 71 0 01422	241	LDX	=040000	
00556	0 02 0 00644	242	PTLW	1,4	
00557	0 60 0 01226	243	LOOP2 SKR	CONST	
00560	0 20 0 00000	244	NOP		
00561	0 53 0 01226	245	SKN	CONST	HAVE ALL WORDS BEEN PUNCHED
00562	0 01 0 00564	246	BRU	\$+2	NO
00563	0 01 0 00566	247	BRU	\$+3	YES
00564	2 12 0 02000	248	MIW	02000,2	
00565	0 41 0 00557	249	BRX	LOOP2	
00566	0 02 14000	250	TOPW		
00567	0 76 0 01230	251	LDA	ZERO	
00570	0 35 0 01226	252	STA	CONST	
00571	0 76 0 02000	253	LOOP3 LDA	02000	
00572	0 75 0 01325	254	LDB	TYPMSK	
00573	0 70 0 01250	255	SKM	RTYPE+3	END RECORD TEST
00574	0 01 0 00535	256	BRU	RDPTE2+1	
00575	0 43 0 01140	257	BRM	CR	
00576	0 53 0 01223	258	SKN	FLAG	IF SET CHECK FOR LAST PARAMETER
00577	0 01 0 00601	259	BRU	\$+2	IF NOT CHECK FOR FILE COUNT
00600	0 01 0 00624	260	BRU	SERCH1+2	
00601	0 60 0 01256	261	SKR	FIRST+1	
00602	0 20 0 00000	262	NOP		
00603	0 53 0 01256	263	SKN	FIRST+1	ARE THERE MORE RECORDS
00604	0 01 0 00340	264	BRU	RDPTE	
00605	0 51 0 00534	265	BRR	RDPTE2	
00606	0 00 00000	266	SERCH PZE	0	
00607	0 76 0 01257	267	LDA	FIRST+2	
00610	0 70 0 01360	268	SKM	THRU	IF TRUE - 1ST PARAMETER IS < 5 CHAR
00611	0 01 0 00614	269	BRU	\$+3	
00612	0 43 0 00625	270	BRM	LIMITS	
00613	0 01 0 00622	271	BRU	SERCH1	
00614	0 76 0 01260	272	LDA	FIRST+3	

00615	0	70	0	01360	273	SKM	THRU	
00616	0	51	0	00606	274	BRR	SERCH	NO COPY PARAMETERS USED
00617	0	61	0	00630	275	MIN	LIMITS+3	FIRST PARAMETER > 4 CHARACTERS
00620	0	43	0	00625	276	BRM	LIMITS	
00621	0	60	0	00630	277	SKR	LIMITS+3	RESTORE TO INITIAL VALUE
00622	0	76	0	01342	278	SERCH1	LDA SEVENS	
00623	0	35	0	01223	279	STA	FLAG	SET FLAG INDICATING USE OF PARAMETERS
00624	0	01	0	00340	280	BRU	RDPTE	
00625	0	00	00000		281	LIMITS	PZE 0	SET
00626	0	76	0	01256	282	LDA	FIRST+1	PARAM 1 AND PARAM2
00627	0	35	0	01221	283	STA	PARAM1	TO CORRECT
00630	0	76	0	01260	284	LDA	FIRST+3	PARAMETERS
00631	0	35	0	01222	285	STA	PARAM2	DETERMINED BY
00632	0	51	0	00625	286	BRR	LIMITS	VALUES KEYED IN
00633	0	00	00000		287	CKINP	PZE 0	ROUTINE TO FIND 1ST PARAMETER
00634	0	76	0	01241	288	LDA	NOREC	NUMBER OF RECORDS
00635	0	35	0	01244	289	STA	BINCK	
00636	0	76	0	01421	290	LDA	=02000	
00637	0	35	0	01243	291	STA	FRSTWD	
00640	0	76	0	01263	292	CKINP1	LDA REF1	
00641	0	35	0	01240	293	STA	TEMP	
00642	0	76	1	01243	294	CKINP2	LDA *FRSTWD	
00643	0	75	0	01342	295	LDB	SEVENS	
00644	0	70	0	01221	296	SKM	PARAM1	CHECK FOR INPUT PARAMETER
00645	0	01	0	00647	297	BRU	\$+2	
00646	0	01	0	00671	298	BRU	SETF1	
00647	0	61	0	01243	299	MIN	FRSTWD	
00650	0	60	0	01240	300	SKR	TEMP	REDUCE WORD COUNT
00651	0	76	0	01240	301	LDA	TEMP	
00652	0	70	0	01230	302	SKM	ZERO	HAVE ALL WORDS OF THIS RECORD
00653	0	01	0	00642	303	BRU	CKINP2	BEEN CHECK
00654	0	61	0	00640	304	MIN	CKINP1	YES
00655	0	60	0	01244	305	SKR	BINCK	REDUCE TEMP RECORD COUNT
00656	0	76	0	01244	306	LDA	BINCK	
00657	0	70	0	01230	307	SKM	ZERO	HAVE ALL RECORDS BEEN CHECKED
00660	0	01	0	00640	308	BRU	CKINP1	NO
00661	0	76	0	01336	309	LDA	RESET2	YES -RESTORE
00662	0	35	0	00640	310	STA	CKINP1	PGM VALUES
00663	0	53	0	01224	311	SKN	FLAG1	

00664	0	01	0	00666	312	BRU	\$+2	
00665	0	51	0	00633	313	BRR	CKINP	LAST PARAMETER NOT FOUND
00666	0	76	0	01230	314	LDA	ZERO	
00667	0	35	0	01226	315	STA	CONST	
00670	0	01	0	00732	316	BRU	SKPRC+1	
00671	0	76	0	01342	317	SETF1 LDA	SEVENS	
00672	0	35	0	01224	318	STA	FLAG1	
00673	0	76	0	01336	319	LDA	RESET2	
00674	0	35	0	00540	320	STA	CKINP1	
00675	0	51	0	00533	321	BRR	CKINP	PARAMETER HAS BEEN FOUND
00676	0	00	00000	322	CKLAST PZE		0	
00677	0	76	0	01337	323	LDA	MOD	MODIFY SEARCH ROUTINE
00700	0	35	0	00644	324	STA	CKINP2+2	TO SEARCH FOR LAST PARAMETERS
00701	0	76	0	01340	325	LDA	MOD2	
00702	0	35	0	00671	326	STA	SETF1	
00703	0	43	0	00633	327	BRM	CKINP	
00704	0	53	0	01224	328	SKN	FLAG1	IF NEG. LAST FILE NOT FOUND
00705	0	01	0	00707	329	BRU	\$+2	
00706	0	51	0	00676	330	BRR	CKLAST	
00707	0	76	0	01230	331	LDA	ZERO	LAST FILE HAS BEEN FOUND
00710	0	35	0	01223	332	STA	FLAG	RESTORE
00711	0	35	0	01256	333	STA	FIRST+1	VALUE OF INITIAL COND
00712	0	76	0	00622	334	LDA	SERCH1	AND PUNCH LAST
00713	0	35	0	00671	335	STA	SETF1	FILE
00714	0	76	0	01341	336	LDA	MOD3	
00715	0	35	0	00644	337	STA	CKINP2+2	
00716	0	51	0	00676	338	BRR	CKLAST	
00717	0	43	0	00777	339	NTBIN BRM	BUFTS	ROUTINE TO PUNCH NOT BINARY FORMAT
00720	0	71	0	01317	340	LDX	M7	MESSAGE
00721	0	02	0	02641	341	TYPW	1,4	
00722	2	12	0	01417	342	MIW	MSE4+7,2	
00723	0	41	0	00722	343	BRX	\$-1	
00724	0	02	14000	344	TOPW			
00725	0	43	0	00777	345	BRM	BUFTS	
00726	0	43	0	01140	346	BRM	CR	
00727	0	00	0	00000	347	HLT		
00730	0	01	0	00200	348	BRU	BEGIN	
00731	0	43	0	00305	349	SKPRC BRM	SICNT	SKIP FILE ROUTINE
00732	0	76	0	01421	350	LDA	=02000	

00733	0	35	0	01225	351	STA	STRGE	
00734	0	43	0	00777	352	BRM	BUFTS	
00735	0	02	0	02604	353	RPTW	1.4	
00736	0	32	1	01225	354	WIM	*STRGE	
00737	0	61	0	01225	355	MIN	STRGE	
00740	0	40	21000		356	BRTW		
00741	0	01	0	00736	357	BRU	\$-3	
00742	0	02	00000		358	DISW		
00743	0	76	0	02000	359	LDA	02000	
00744	0	75	0	01325	360	LDB	TYFMSK	
00745	0	70	0	01250	361	SKM	RTYPE+3	
00746	0	01	0	00732	362	BRU	SKPRC+1	
00747	0	53	0	01223	363	SKN	FLAG	IS SKIP NORMAL OR SEARCH
00750	0	01	0	00754	364	BRU	\$+4	
00751	0	76	0	01334	365	LDA	RESET	
00752	0	35	0	00360	366	STA	CHTK0+1	
00753	0	01	0	00624	367	BRU	SERCH1+2	SEARCH TYPE SKIP
00754	0	60	0	01256	368	SKR	FIRST+1	
00755	0	20	0	00000	369	N0P		
00756	0	53	0	01256	370	SKN	FIRST+1	
00757	0	01	0	00732	371	BRU	SKPRC+1	MORE FILES REMAIN TO BE SKIPPED
00760	0	01	0	00200	372	BRU	BEGIN	
00761	0	00	00000		373	CKE0F	PZE	CHECK FOR EOF RECORD
00762	0	76	0	01226	374	LDA	CONST	
00763	0	75	0	01342	375	LDB	SEVENS	
00764	0	70	0	01423	376	SKM	=1	IS RECORD ONE WORD
00765	0	51	0	00761	377	BRR	CKE0F	N0
00766	0	76	0	02000	378	LDA	02000	
00767	0	70	0	01425	379	SKM	=017170000	YES-IS IT AN EOF
00770	0	51	0	00761	380	BRR	CKE0F	N0
00771	0	43	0	00777	381	BRM	BUFTS	YES PUNCH EOF
00772	0	02	0	00644	382	PTLW	1.4	
00773	0	12	0	02000	383	MIW	02000	
00774	0	02	14000		384	T0PW		
00775	0	43	0	00777	385	BRM	BUFTS	
00776	0	01	0	00200	386	BRU	BEGIN	
00777	0	00	00000		387	BUFTS	PZE	
01000	0	40	21000		388	BRTW		
01001	0	01	0	01000	389	BRU	\$-1	

01002	0 51 0 00777	390	BRR	BUFTS	
01003	0 00 00000	391	CKBIN	PZE	0
01004	0 76 0 01241	392	LDA	NOREC	NUMBER OF RECORDS READ
01005	0 35 0 01244	393	STA	BINCK	
01006	0 76 0 01421	394	LDA	=02000	
01007	0 35 0 01243	395	STA	FRSTWD	
01010	0 76 1 01243	396	RECIM	LDA	*FRSTWD
01011	0 75 0 01424	397	LDB	=070000	IMAGE OF FIRST WORD OF RECORD
01012	0 70 0 01322	398	SKM	BINRY	MASK OF BINARY CODE POSITION
01013	0 01 0 00717	399	BRU	NTBIN	IF RECORD IN BINARY FORMAT
01014	0 60 0 01244	400	SKR	BINCK	NOT BINARY FORMAT
01015	0 75 0 01426	401	LDB	=077777777	REDUCE RECORD COUNT
01016	0 76 0 01244	402	LDA	BINCK	
01017	0 70 0 01230	403	SKM	ZERO	ARE THERE MORE RECORDS TO CHECK
01020	0 01 0 01022	404	BRU	\$+2	YES
01021	0 01 0 01027	405	BRU	RESET1	NO
01022	0 76 0 01263	406	THUP	LDA	REF1
01023	0 55 0 01243	407	ADD	FRSTWD	
01024	0 35 0 01243	408	STA	FRSTWD	STARTING ADDRESS OF NEXT RECORD
01025	0 61 0 01022	409	MIN	THUP	
01026	0 01 0 01010	410	BRU	RECIM	
01027	0 76 0 01336	411	RESET1	LDA	RESET2
01030	0 35 0 01022	412	STA	THUP	
01031	0 51 0 01003	413	BRR	CKBIN	
01032	0 00 00000	414	LBLCK1	PZE	0
01033	0 76 0 01241	415	LDA	NOREC	NUMBER OF RECORDS
01034	0 35 0 01244	416	STA	BINCK	
01035	0 76 0 01421	417	LDA	=02000	
01036	0 35 0 01243	418	STA	FRSTWD	
01037	0 76 1 01243	419	LBLCK2	LDA	*FRSTWD
01040	0 75 0 01325	420	LDB	TYPMSK	FIRST WORD OF RECORD
01041	0 70 0 01230	421	SKM	ZERO	IF RECORD TYPE 0 RESTORE AND EXIT
01042	0 01 0 01047	422	BRU	LBLCK3	
01043	0 76 0 01336	423	RESET3	LDA	RESET2
01044	0 35 0 01047	424	STA	LBLCK3	EXIT
01045	0 35 0 01131	425	STA	RECADR	
01046	0 51 0 01032	426	BRR	LBLCK1	
01047	0 76 0 01263	427	LBLCK3	LDA	REF1
01050	0 35 0 01234	428	STA	RCLNTH	NUMBER OF WORDS IN RECORD TO BE CHECKED

01051	0	61	0	01047	429	MIN	LBLCK3	
01052	0	76	0	01243	430	LBLCK	LDA	FRSTWD
01053	0	55	0	01427	431		ADD	=03
01054	0	35	0	01236	432		STA	RADR1
01055	0	53	1	01236	433		SKN	*RADR1
01056	0	01	0	01113	434		BRU	NXLABL
01057	0	76	0	01236	435		LDA	RADR1
01060	0	54	0	01430	436		SUB	=02
01061	0	35	0	01237	437		STA	RADR2
01062	0	02	0	02041	438		TYPW	1,1
01063	0	71	0	01315	439		LDB	M4
01064	0	76	1	01237	440	LATYP	LDA	*RADR2
01065	0	75	0	01327	441		LDB	LAMSK
01066	0	70	0	01331	442		SKM	BLNKS
01067	0	01	0	01075	443		BRU	LAOUT
01070	0	12	0	01326	444		MIW	TBLNK
01071	0	6720	006		445		LCY	6
01072	0	41	0	01065	446		BRX	LATYP+1
01073	0	61	0	01237	447		MIN	RADR2
01074	0	01	0	01103	448		BRU	CKADR
01075	0	35	0	01242	449	LAOUT	STA	LAROT
01076	0	12	0	01242	450		MIW	LAROT
01077	0	6720	006		451		LCY	6
01100	0	35	0	01242	452		STA	LAROT
01101	0	41	0	01065	453		BRX	LATYP+1
01102	0	61	0	01237	454		MIN	RADR2
01103	0	76	0	01236	455	CKADR	LDA	RADR1
01104	0	75	0	01330	456		LDB	MSKAD
01105	0	70	0	01237	457		SKM	RADR2
01106	0	01	0	01063	458		BRU	LATYP-1
01107	0	02	14000		459	LADNE	TOPW	
01110	0	76	0	01324	460		LDA	ADDR
01111	0	35	0	01064	461		STA	LATYP
01112	0	43	0	01140	462		BRM	CR
01113	0	76	0	01234	463	NXLABL	LDA	RCLNTH
01114	0	54	0	01427	464		SUB	=03
01115	0	35	0	01234	465		STA	RCLNTH
01116	0	75	0	01342	466		LDB	SEVENS
01117	0	53	0	01234	467		SKN	RCLNTH

WORD CONTAINING ITEM TYPE
SHOULD LABEL BE TYPED

FIRST LABEL WORD

60 BLANKS

OUTPUT 12 BLANK

SECOND LABEL WORD

OUTPUT CHARACTER
GET NEXT CHARACTER

MASK ADDRESS FIELD

GET 2ND WORD OF LABEL

SET TO INITIAL ADDRESS

LENGTH OF RECORD REMAINING
TO BE
CHECKED

01120	0 01 0	01122	468	BRU	\$+2	
01121	0 01 0	01124	469	BRU	\$+3	
01122	0 70 0	01423	470	SKM	=01	HAVE ALL WORDS BEEN CHECKED
01123	0 01 0	01136	471	BRU	NEXT3	NO
01124	0 60 0	01244	472	SKR	BINCK	
01125	0 76 0	01244	473	LDA	BINCK	YES
01126	0 70 0	01230	474	SKM	ZERO	ARE THERE MORE RECORDS TO BE CHECKED
01127	0 01 0	01131	475	BRU	\$+2	YES
01130	0 01 0	01043	476	BRU	RESET3	NO
01131	0 76 0	01263	477	RECADR LDA	REF1	
01132	0 55 0	01243	478	ADD	FRSTWD	
01133	0 35 0	01243	479	STA	FRSTWD	FIRST WORD OF NEXT RECORD
01134	0 61 0	01131	480	MIN	RECADR	
01135	0 01 0	01037	481	BRU	LBLCK2	
01136	0 76 0	01236	482	NEXT3 LDA	RADR1	
01137	0 01 0	01053	483	BRU	LBLCK+1	
01140	0 00 00000		484	CR PZE	0	
01141	0 71 0	01431	485	LDX	=-6500	
01142	0 41 0	01142	486	BRX	\$	
01143	0 43 0	00777	487	BRM	BUFTS	
01144	0 02 0	02041	488	TYPW	1.1	
01145	0 12 0	01432	489	MIW	=052000000	
01146	0 02 14000		490	TOPW		
01147	0 43 0	00777	491	BRM	BUFTS	
01150	0 71 0	01431	492	LDX	=-6500	
01151	0 41 0	01151	493	BRX	\$	
01152	0 51 0	01140	494	BRR	CR	
01153	0 00 00000		495	WORDX PZE	0	FORM WORD FROM KEYED INPUTS
01154	0 71 0	01315	496	LDX	M4	SET TO PACK WORDS
01155	2 76 0	01255	497	LDA	NAME1+4.2	
01156	0 6720 022		498	LCY	18	
01157	0 75 0	01230	499	LDB	ZERO	
01160	0 6620 022		500	RCY	18	
01161	2 35 0	01255	501	STA	NAME1+4.2	
01162	0 41 0	01155	502	BRX	\$-5	
01163	0 71 0	01314	503	LDX	M3	
01164	0 75 0	01230	504	LDB	ZERO	
01165	2 76 0	01254	505	LDA	NAME1+3.2	
01166	0 6700 006		506	LSH	6	

01167	2	55	0	01255	507	ADD	NAME1+4,2
01170	0	41	0	01166	508	BRX	\$-2
01171	0	35	0	01255	509	INMFY STA	FIRST
01172	0	61	0	01171	510	MIN	\$-1
01173	0	71	0	01315	511	LDX	M4
01174	0	76	0	01331	512	LDA	BLNKS
01175	2	35	0	01255	513	STA	NAME1+4,2
01176	0	41	0	01175	514	BRX	\$-1
01177	0	02	20001		515	ROV	
01200	0	51	0	01153	516	BRR	WORDX
01201	0	43	0	01140	517	NOTYP BRM	CR
01202	0	71	0	01317	518	LDX	M7
01203	0	02	0	02641	519	TYPW	1,4
01204	2	12	0	01371	520	MIW	MSG1+7,2
01205	0	41	0	01204	521	BRX	\$-1
01206	0	02	14000	~	522	TOPW	
01207	0	43	0	01140	523	BRM	CR
01210	0	01	0	00200	524	BRU	BEGIN
01211	0	43	0	01140	525	CTERR BRM	CR
01212	0	71	0	01317	526	LDX	M7
01213	0	02	0	02641	527	TYPW	1,4
01214	2	12	0	01410	528	MIW	MSG3+7,2
01215	0	41	0	01214	529	BRX	\$-1
01216	0	02	14000		530	TOPW	
01217	0	43	0	01140	531	BRM	CR
01220	0	01	0	00200	532	BRU	BEGIN
01221	0	00	00000		533	PARAM1 PZE	0
01222	0	00	00000		534	PARAM2 PZE	0
01223	0	00	00000		535	FLAG PZE	0
01224	0	00	00000		536	FLAG1 PZF	0
01225	0	00	00000		537	STRGE PZE	0
01226	0	00	00000		538	CONST PZE	0
01227	0	00	00000		539	CRUNT PZE	0
01230	0	00	00000		540	ZERO PZE	0
01231	0	00	00000		541	CHBUF PZE	0
01232	0	00	00000		542	MEM PZE	0
01233	0	00	00000		543	XTOTEN PZE	0
01234	0	00	00000		544	ROLNTH PZE	0
01235	0	00	00000		545	RADR PZE	0

01236	0 00 00000	546	RADR1	PZE	0
01237	0 00 00000	547	RADR2	PZE	0
01240	0 00 00000	548	TEMP	PZE	0
01241	0 00 00000	549	NOREC	PZE	0
01242	0 00 00000	550	LAROT	PZE	0
01243	0 00 00000	551	FRSTWD	PZE	0
01244	0 00 00000	552	BINCK	PZE	0
01245	0 00 00000	553	RTYPE	PZE	0
01246	10000000	554		DATA	010000000
01247	20000000	555		DATA	020000000
01250	30000000	556		DATA	030000000
01251		557	NAME1	RES	4
01255		558	FIRST	RES	6
01263		559	REF1	RES	20
01307	00000077	560	CHMSK	DATA	000000077
01310	00000012	561	BLANK	DATA	000000012
01311	00000033	562	PERID	DATA	000000033
01312	00000052	563	CARET	DATA	000000052
01313	00000061	564	KYERR	DATA	000000061
01314	00077775	565	M3	DATA	000077775
01315	00077774	566	M4	DATA	000077774
01316	00077772	567	M6	DATA	000077772
01317	00077771	568	M7	DATA	0777771
01320	00077770	569	M9	DATA	000077770
01321	00077754	570	M24	DATA	077754
01322	00050000	571	BINRY	DATA	000050000
01323	00000057	572	DELTA	DATA	057
01324	0 76 1 01237	573	ADRR	LDA	*RADR2
01325	70000000	574	TYPMSK	DATA	070000000
01326	12000000	575	TBLNK	DATA	012000000
01327	77000000	576	LAMSK	DATA	077000000
01330	00077777	577	MSKAD	DATA	077777
01331	60606060	578	BLNKS	DATA	060606060
01332	0 00 0 00000	579	ERROR	HLT	
01333	0 76 0 01261	580	TEST	LDA	FIRST+4
01334	0 35 0 01263	581	RESET	STA	REF1
01335	0 35 0 01255	582	REM0D	STA	FIRST
01336	0 76 0 01263	583	RESET2	LDA	REF1
01337	0 70 0 01222	584	M0D	SKM	PARAM2

KEY ERROR TO BE COMPLETED

REINITIALIZE STORAGE LOCATION

01340	0 76 0 01230	585	MOD2	LDA	ZERO
01341	0 70 0 01221	586	MOD3	SKM	PARAM1
01342	77777777	587	SEVENS	DATA	077777777
01343	03200003	588	WIM3	DATA	003200003
01344	00000000	589	TENS	DATA	0
01345	00000012	590		DATA	012
01346	00000024	591		DATA	024
01347	00000036	592		DATA	036
01350	00000050	593		DATA	050
01351	00000062	594		DATA	062
01352	00000074	595		DATA	074
01353	00000106	596		DATA	0106
01354	00000120	597		DATA	0120
01355	22464663	598	BOOT	TEXT	<BOOT>
01356	23464770	599	COPY	TEXT	<COPY>
01357	62423147	600	SKIP	TEXT	<SKIP>
01360	63305164	601	THRU	TEXT	<THRU>
01361	26314325	602	FILE	TEXT	<FILE>
01362	51252346	603	MSG1	TEXT	<RECORD NOT IN SYMBOL FORMAT.>
01363	51241245				
01364	46631231				
01365	45126270				
01366	44224643				
01367	12264651				
01370	44216333				
01371	31434325	604	MSG2	TEXT	<ILLEGAL BOOT FORMAT ON TAPE READ>
01372	27214312				
01373	22464663				
01374	12264651				
01375	44216312				
01376	46451263				
01377	21472512				
01400	51252124				
01401	12234647	605	MSG3	TEXT	< COPY INSTRUCTION NOT FOUND.>
01402	70123145				
01403	62635164				
01404	23633146				
01405	45124546				
01406	63122646				

01407	64452433			
01410	51252346	606	MSG4	TEXT
01411	51241245			<RECORD NOT IN BINARY FORMAT.>
01412	46631231			
01413	45122231			
01414	45215170			
01415	12264651			
01416	44216333			
	00000200	607		END
01417	00770000			0200
01420	00600000			
01421	00002000			
01422	00040000			
01423	00000001			
01424	00070000			
01425	17170000			
01426	77777777			
01427	00000003			
01430	00000002			
01431	77763234			
01432	52000000			